

Reduce Wiring to Control Devices with Short-Barrel 2-Wire DC Prox Sensors









- Thick nickel-plated brass barrel has wrench flats for easy installation
- Solid potted internal circuitry withstands shocks and water washdown to IP67
- High visibility indicator
- Choose prewired or connector models



Ordering Information

WHEN ORDERING, PLEASE NOTE: Omron has added the suffix “-N” to E2E part numbers for ordering purposes only; the suffix “-N” will not appear on the product.











■ PREWIRED SENSORS

Self-diagnostic output function	Type	Size	Sensing distance	Part number	
				NO (Note.)	NC
Yes	Shielded 	M12	 3 mm	E2E-X3D1S-N	---
		M18	 7 mm	E2E-X7D1S-N	---
		M30	 10 mm	E2E-X10D1S-N	---
	Unshielded 	M12	 8 mm	E2E-X8MD1S-N	---
		M18	 14 mm	E2E-X14MD1S-N	---
		M30	 20 mm	E2E-X20MD1S-N	---

Note: A different oscillating frequency is available. Add a “5” to the part number (e.g., E2E-X3D15-N-N).













(This table continues on the next page.)

Ordering Information - continued from previous page

Self-diagnostic output function	Type	Size	Sensing distance	Part number	
				NO (Notes 1, 2.)	NC
No	Shielded 	M8	 2 mm	E2E-X2D1-N-N	E2E-X2D2-N-N
		M12	 3 mm	E2E-X3D1-N-N	E2E-X3D2-N-N
		M18	 7 mm	E2E-X7D1-N-N	E2E-X7D2-N-N
		M30	 10 mm	E2E-X10D1-N-N	E2E-X10D2-N-N
	Unshielded 	M8	 4 mm	E2E-X4MD1-N	E2E-X4MD2-N
		M12	 8 mm	E2E-X8MD1-N	E2E-X8MD2-N
		M18	 14 mm	E2E-X14MD1-N	E2E-X14MD2-N
		M30	 20 mm	E2E-X20MD1-N	E2E-X20MD2-N

- Note: 1. A different oscillating frequency is available. Add a "5" to the part number (e.g., E2E-X3D15-N-N).
 2. E2E sensors with robotic cable are available. Add a "R" in the part number (e.g., E2E-X3D1-R-N).



■ SENSORS WITH BUILT-IN CONNECTOR

Connector size	Self-diagnostic output function	Type	Size	Sensing distance	Part number	
					NO (Pins 1 and 4)	NC (Pins 1 and 2)
M12/Micro Change®	Yes	Shielded 	M12	 3 mm	E2E-X3D1S-M1-N	---
			M18	 7 mm	E2E-X7D1S-M1-N	---
			M30	 10 mm	E2E-X10D1S-M1-N	---
		Unshielded 	M12	 8 mm	E2E-X8MD1S-M1-N	---
			M18	 14 mm	E2E-X14MD1S-M1-N	---
			M30	 20 mm	E2E-X20MD1S-M1-N	---
	No	Shielded 	M8	 2 mm	E2E-X2D1-M1G-N	E2E-X2D2-M1G-N
M12			 3 mm	E2E-X3D1-M1G-N (See Note 1.)	E2E-X3D2-M1G-N	
M18			 7 mm	E2E-X7D1-M1G-N (See Note 1.)	E2E-X7D2-M1G-N	
M30			 10 mm	E2E-X10D1-M1G-N (See Note 1.)	E2E-X10D2-M1G-N	

- Note: 1. A different oscillating frequency is available. Add a "5" to the part number (e.g., E2E-X3D15-N-N).
 2. E2E sensors with a "G" in the part number denotes alternate pin arrangement. Refer to the *Connections* section.
 3. Connector cordsets: For MicroChange® use OMRON Y96E-44□D□; for NanoChange® use Omron XS3F-M42□-40□-R.



(This table continues on the next page.)

Ordering Information - continued from previous page

Connector size	Self-diagnostic output function	Type	Size	Sensing distance	Part number	
					NO (Pins 1 and 4)	NC (Pins 1 and 2)
M12/Micro Change®	No	Unshielded 	M8	4 mm	E2E-X4MD1-M1G-N	E2E-X4MD2-M1G-N
			M12	8 mm	E2E-X8MD1-M1G-N (See Note 1.)	E2E-X8MD2-M1G-N
			M18	14 mm	E2E-X14MD1-M1G-N (See Note 1.)	E2E-X14MD2-M1G-N
			M30	20 mm	E2E-X20MD1-M1G-N (See Note 1.)	E2E-X20MD2-M1G-N
M8/Nano Change®	No	Shielded 	M8	2 mm	E2E-X2D1-M3G	E2E-X2D2-M3G
		Unshielded 		4 mm	E2E-X4MD1-M3G	E2E-X4MD2-M3G











- Note: 1. A different oscillating frequency is available. Add a "5" to the part number (e.g., E2E-X3D15-N-N).
2. E2E sensors with a "G" in the part number denotes alternate pin arrangement. Refer to the *Connections* section.
3. Connector cordsets: For MicroChange® use OMRON Y96E-44□D□; for NanoChange® use Omron XS3F-M42□-40□-R.

■ SENSOR WITH PIGTAIL CONNECTOR

Type	Size	Sensing distance	Polarity	Part number
				NO
Shielded 	M12	3 mm	Yes	E2E-X3D1-M1GJ-N
			No	E2E-X3D1-M1J-T-N
	M18	7 mm	Yes	E2E-X7D1-M1GJ-N
			No	E2E-X7D1-M1J-T-N
	M30	10 mm	Yes	E2E-X10D1-M1GJ-N
			No	E2E-X10D1-M1J-T-N
Unshielded 	M12	8 mm	Yes	E2E-X8MD1-M1GJ-N
	M18	14 mm		E2E-X14MD1-M1GJ-N
	M30	20 mm		E2E-X20MD1-M1GJ-N

- Note: 1. A model with no polarity has a residual voltage of 5 V, which must be taken into consideration together with the interface condition (the PLC's ON voltage, for example) when connecting the proximity sensor to a load.
2. Connector cordsets: Use OMRON Y96E-44□D□.

■ SENSOR WITH FOUR-PIN CONNECTOR

Type	Size	Sensing distance	Part number	
			NO (Pins 3 and 4)	NC (Pins 2 and 3)
Shielded 	M8	 2 mm	E2E-X2D1-M1-N	E2E-X2D2-M1-N
	M12	 3 mm	E2E-X3D1-M1-N	E2E-X3D2-M1-N
	M18	 7 mm	E2E-X7D1-M1-N	E2E-X7D2-M1-N
	M30	 10 mm	E2E-X10D1-M1-N	E2E-X10D2-M1-N
Unshielded 	M8	 4 mm	E2E-X4MD1-M1-N	E2E-X4MD2-M1-N
	M12	 8 mm	E2E-X8MD1-M1-N	E2E-X8MD2-M1-N
	M18	 14 mm	E2E-X14MD1-M1-N	E2E-X14MD2-M1-N
	M30	 20 mm	E2E-X20MD1-M1-N	E2E-X20MD2-M1-N

■ ACCESSORIES

Description	Part number	
Mounting brackets	Fits M8 size sensors	Y92E-B8
	Fits M12 size sensors	Y92E-B12
	Fits M18 size sensors	Y92E-B18
	Fits M30 size sensors	Y92E-B30
Silicone rubber covers for shielded sensors	Fits M12 size sensors	Y92E-E12-2
	Fits M18 size sensors	Y92E-E18-2
	Fits M30 size sensors	Y92E-E30-2
Connector cordsets	See Y96E and XS Connector Cordsets data sheets for details	

Note: Use OMRON Y96E-44□□ cordsets with M12 connector; use XS3F cordsets with M8 connector.

■ REPLACEMENT PARTS

Description	Part number	
Mounting hardware including one pair of metal nuts and one washer	Fits M8 size sensors	M8-MHWS
	Fits M12 size sensors	M12-MHWS
	Fits M18 size sensors	M18-MHWS
	Fits M30 size sensors	M30-MHWS

Specifications

■ RATINGS/CHARACTERISTICS

Part number	E2E-X2D□-N	E2E-X4MD□-N	E2E-X3D□-N	E2E-X8MD□-N	E2E-X7D□-N	E2E-X14MD□-N	E2E-X10D□-N	E2E-X20MD□-N
Size	M8		M12		M18		M30	
Type	Shielded	Unshielded	Shielded	Unshielded	Shielded	Unshielded	Shielded	Unshielded
Sensing distance	2 mm (0.08 in) ±10%	4 mm (0.16 in) ±10%	3 mm (0.12 in) ±10%	8 mm (0.31 in) ±10%	7 mm (0.28 in) ±10%	14 mm (0.55 in) ±10%	10 mm (0.39 in) ±10%	20 mm (0.79 in) ±10%
Supply voltage (operating voltage)	12 to 24 VDC, ripple (p-p): 10% max., (10 to 30 VDC)							
Leakage current	0.8 mA max.							
Sensing object	Magnetic metals (refer to <i>Engineering Data</i> for non-magnetic metals)							
Setting distance	0 to 1.6 mm (0 to 0.06 in)	0 to 3.2 mm (0 to 0.13 in)	0 to 2.4 mm (0 to 0.09 in)	0 to 6.4 mm (0 to 0.25 in)	0 to 5.6 mm (0 to 0.22 in)	0 to 11.2 mm (0 to 0.44 in)	0 to 8.0 mm (0 to 0.31 in)	0 to 16.0 mm (0 to 0.63 in)
Standard object (mild steel)	8 x 8 x 1 mm (0.31 x 0.31 x 0.04 in)	20 x 20 x 1 mm (0.79 x 0.79 x 0.04 in)	12 x 12 x 1 mm (0.47 x 0.47 x 0.04 in)	30 x 30 x 1 mm (1.18 x 1.18 x 0.04 in)	18 x 18 x 1 mm (0.71 x 0.71 x 0.04 in)	30 x 30 x 1 mm (1.18 x 1.18 x 0.04 in)	30 x 30 x 1 mm (1.18 x 1.18 x 0.04 in)	54 x 54 x 1 mm (2.13 x 2.13 x 0.04 in)
Differential travel	15% max. of sensing distance		10% max. of sensing distance					
Response frequency	1.5 kHz	1.0 kHz	1.0 kHz	0.8 kHz	0.5 kHz	0.4 kHz	0.4 kHz	0.1 kHz
Operation (with target object approaching)	D1 models: Load ON D2 models: Load OFF							
Control output (switching capacity)	3 to 100 mA (5 to 100 mA with residual voltage of 5V for -M1J-T models) Diagnostic output: 50 mA for -D1S models							
Diagnostic output delay	0.3 to 1 s							
Circuit protection	Surge absorber, load short-circuit protection (for control and diagnostic output)							
Indicator	D1 models: Operation indicator (red LED), operation set indicator (green LED) D2 models: Operation indicator (red LED)							
Ambient temperature	Operating: -25°C to 70°C (-13°F to 158°F) with no icing							
Ambient humidity	Operating: 35% to 95%							
Temperature influence	±15% max. of sensing distance at 23°C in temperature range of -25°C to 70°C (-13°F to 158°F)		±10% max. of sensing distance at 23°C in temperature range of -25°C to 70°C (-13°F to 158°F)					
Voltage influence	±1% max. of sensing distance in rated voltage range ±15%							
Residual voltage	3.0 V max. (under load current of 100 mA with cable length of 2 m) 5.0 V min. for -M1J-T models							
Insulation resistance	50 MΩ min. (at 500 VDC) between current carry parts and case							
Dielectric strength	1,000 VAC for 1 min between current carry parts and case							
Vibration resistance	10 to 55 Hz, 1.5-mm double amplitude for 10 times each in X, Y, and Z axes							
Shock resistance	500 m/s ² (approx. 50G) for 10 times each in X, Y, and Z axes		1,000 m/s ² (approx. 100G) for 10 times each in X, Y, and Z axes					
Enclosure rating	IEC	IP67						
	NEMA	1, 4, 6, 12, 13						
Weight	Approx. 45 g		Approx. 120 g		Approx. 160 g		Approx. 220 g	
Material	Body	Stainless steel		Brass				
	Sensing face	PBT						

Operation

■ OUTPUT CIRCUITS

E2E-X□D□-N DC 2-wire Models

E2E-X□D□-N

Without Diagnostic Output

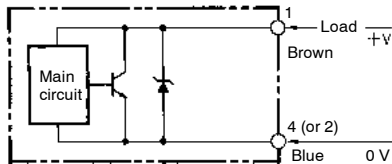

E2E-X□D1-M1J-T-N

No Polarity

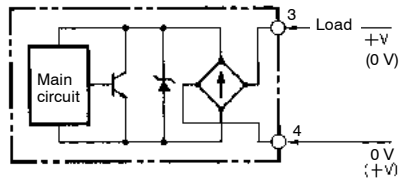

- Note:
1. The load can be connected to either the +V or 0-V side.
 2. The E2E-X□D1-M1J-T has no polarity. Therefore, terminals 3 and 4 have no polarity.

E2E-X□D1S-N

With Diagnostic Output

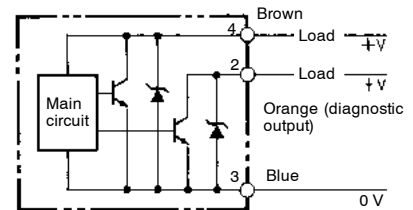

Short-Circuit Indication

The LED dims when the load is shorted and the load output immediately turns off and remains off until the short-circuit protection is reset.

Resetting Short-Circuit Protection

Before the short-circuit protection can be reset, the short must be repaired. We recommend turning the power off before repairing the short. If this approach is taken, no further action is required to reset the short-circuit protection.

If the short must be repaired with power on, the following resetting steps are required:

For NO sensors, the target must be removed to reset the short-circuit protection.

For NC sensors, the target must be presented then removed to reset the short-circuit protection.

OPERATING CHARTS

E2E-X□D1-N

NO Type

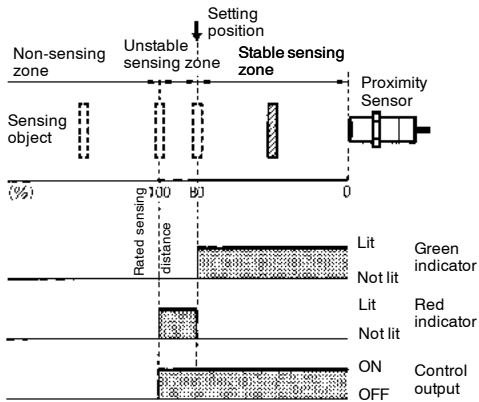

E2E-X□D2-N

NC Type

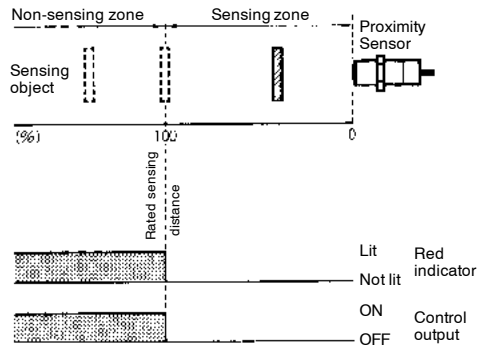

E2E-X□D1S-N

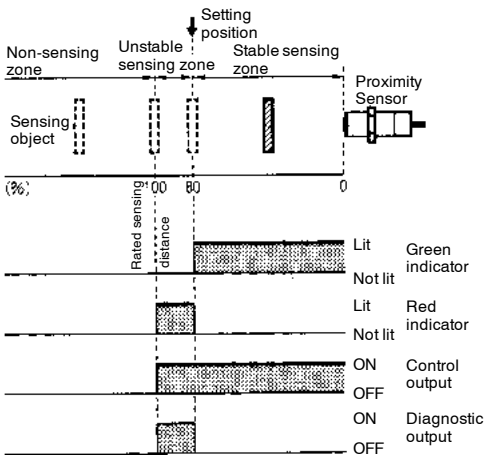

Note: The diagnostic output of the E2E-X□D1S-N is ON when there is a coil burnout or the sensing object is located in the unstable sensing range for 0.3 s or more.

Engineering Data

■ OPERATING RANGE (TYPICAL)

Shielded Models

E2E-X□D□-N

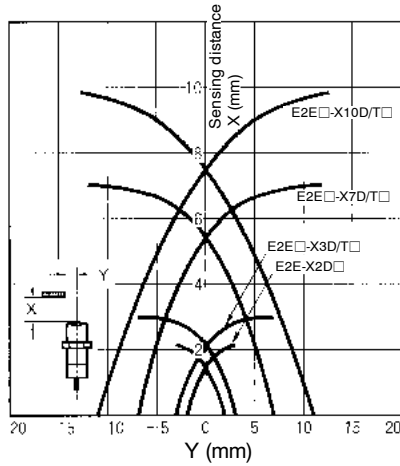

Unshielded Models

E2E-X□MD□-N

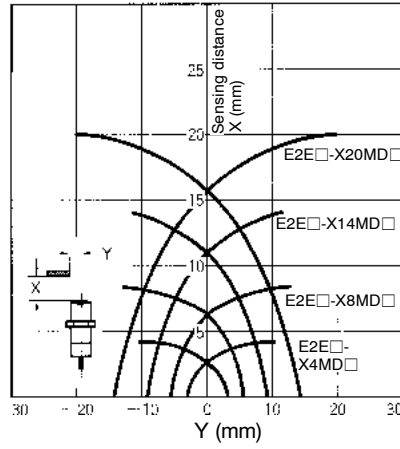

■ LEAKAGE CURRENT (TYPICAL)

E2E-X□D□-N

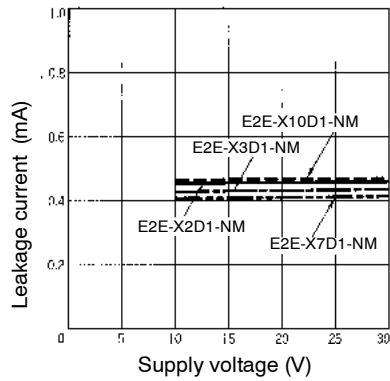

■ RESIDUAL OUTPUT VOLTAGE (TYPICAL)

E2E-X□D□-N

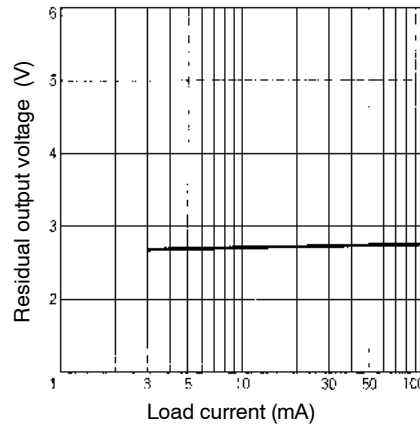

■ SENSING DISTANCE VS. SENSING OBJECT (TYPICAL)

E2E-X2D□-N

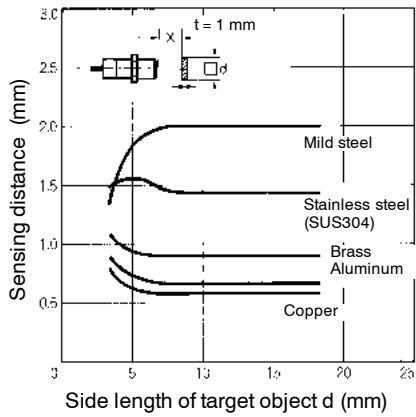

E2E-X3D□-N

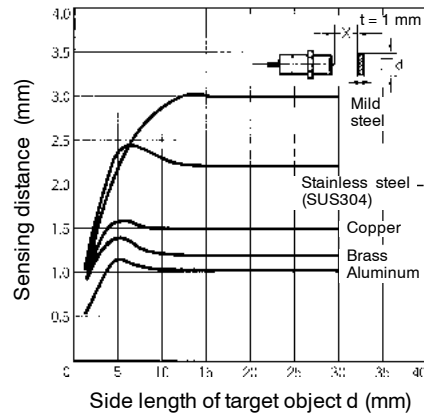

E2E-X7D□-N

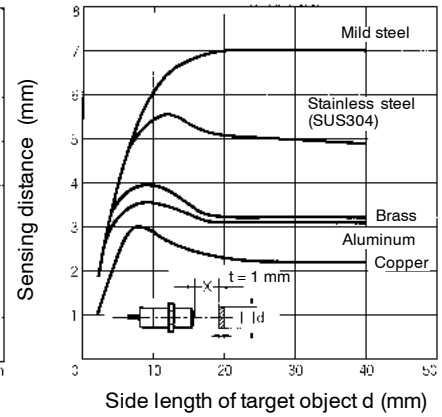

E2E-X10D□-N

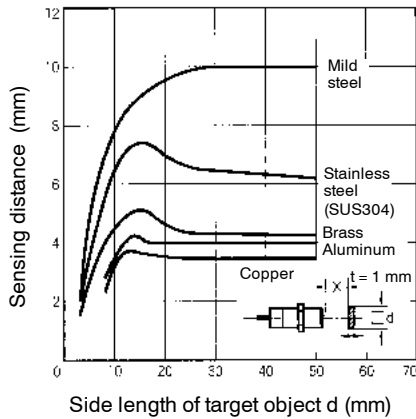

E2E-X4MD□-N

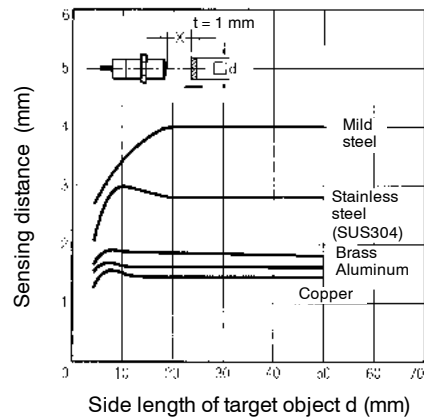

E2E-X8MD□-N

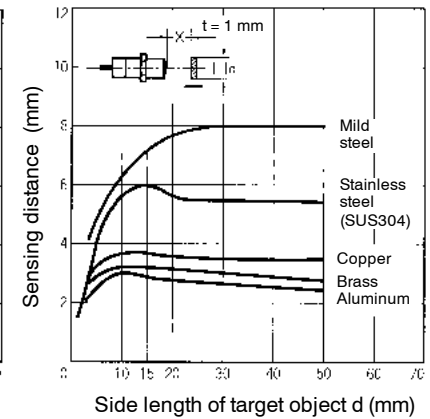

E2E-X14MD□-N

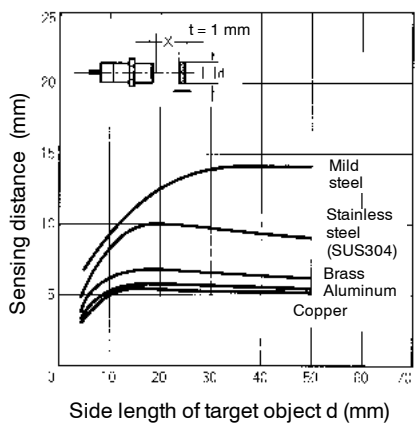

E2E-X20MD□-N

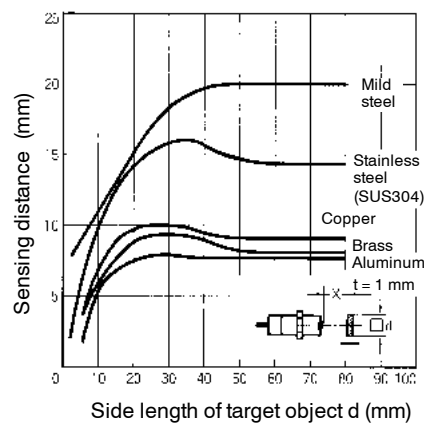

Dimensions

■ DRAWING LOCATOR

Type			Part number	Figure number
Pre-wired	Shielded	M8	E2E-X2D□-N-N	1
		M12	E2E-X3D□-N-N	3
		M18	E2E-X7D□-N-N	5
		M30	E2E-X10D□-N-N	7
	Unshielded	M8	E2E-X4MD□-N	2
		M12	E2E-X8MD□-N	4
		M18	E2E-X14MD□-N	6
		M30	E2E-X20MD□-N	8
4-Pin connector (M12)	Shielded	M8	E2E-X2D□-M1G-N	9
		M12	E2E-X3D□-M1G-N	11
		M18	E2E-X7D□-M1G-N	13
		M30	E2E-X10D□-M1G-N	15
	Unshielded	M8	E2E-X4MD□-M1G-N	10
		M12	E2E-X8MD□-M1G-N	12
		M18	E2E-X14MD□-M1G-N	14
		M30	E2E-X20MD□-M1G-N	16
M8 connector	Shielded	M8	E2E-X2D□-M3G-N	17
	Unshielded		E2E-X4MD□-M3G-N	18
Pigtail connector	Shielded	M12	E2E-X3D1-M1GJ-N	19
		M18	E2E-X7D1-M1GJ-N	21
		M30	E2E-X10D1-M1GJ-N	23
	Unshielded	M12	E2E-X8MD1-M1GJ-N	20
		M18	E2E-X14MD1-M1GJ-N	22
		M30	E2E-X20MD1-M1GJ-N	24
Pigtail connector, no polarity	Shielded	M12	E2E-X3D1-M1J-T-N	25
		M18	E2E-X7D1-M1J-T-N	26
		M30	E2E-X10D1-M1J-T-N	27

Unit: mm (inch)

Prewired Models (Shielded)

Fig. 1:

E2E-X2D□-N

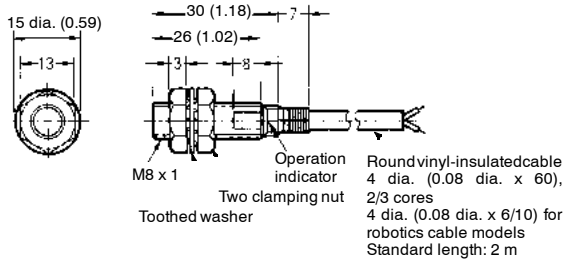

Prewired Models (Unshielded)

Fig. 2:

E2E-X4MD□-N

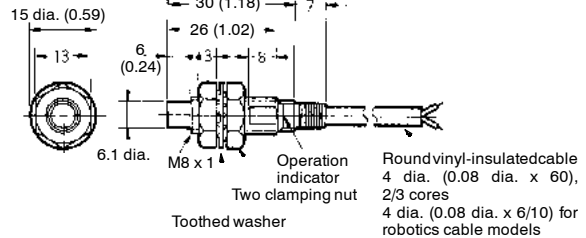

Fig. 3:

E2E-X3D□-N

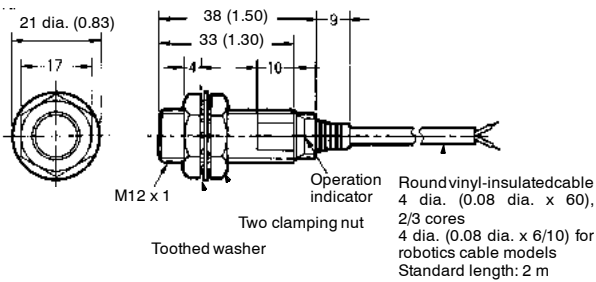
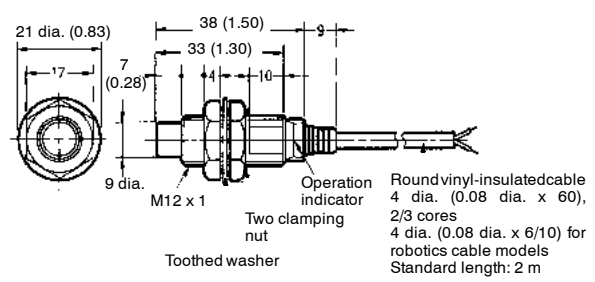

Fig. 4:

E2E-X8MD□-N



Prewired Models (Shielded)

Fig. 5:

E2E-X7D□-N

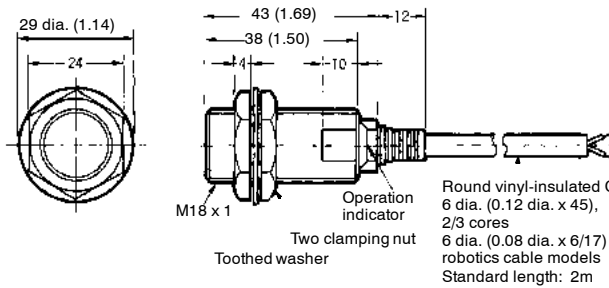

Prewired Models (Unshielded)

Fig. 6:

E2E-X14MD□

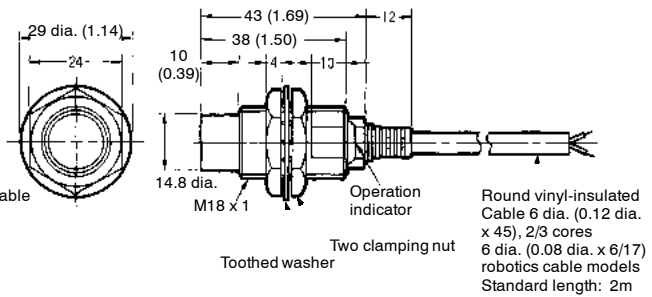

Unit: mm (inch)

Fig. 7:

E2E-X10D□-N

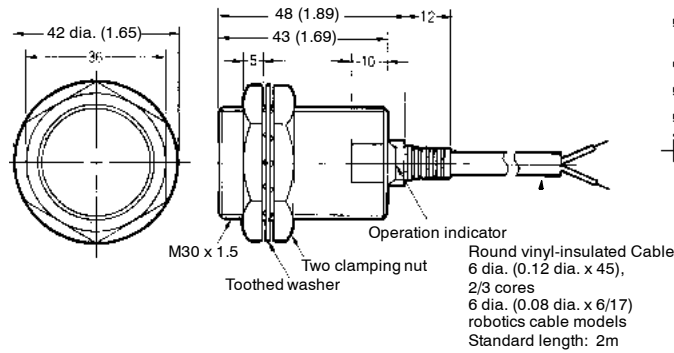
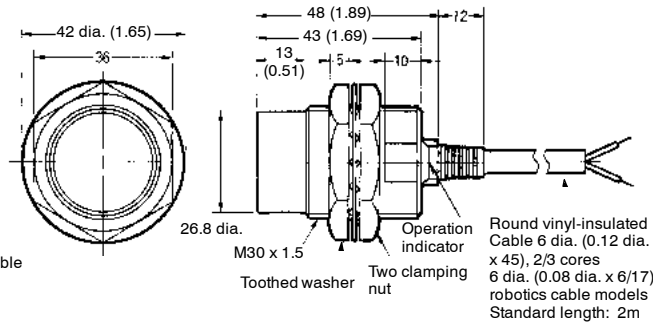

Fig. 8:

E2E-X20MD□



Connector Models (Shielded)

Connector Models (Unshielded)

Fig. 9:

E2E-X2D□-M1G-N

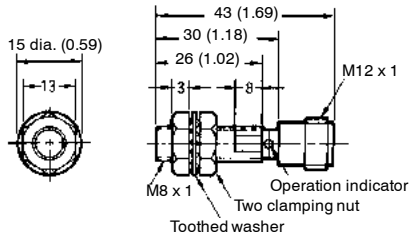

Fig. 10:

E2E-X4MD□-M1G-N

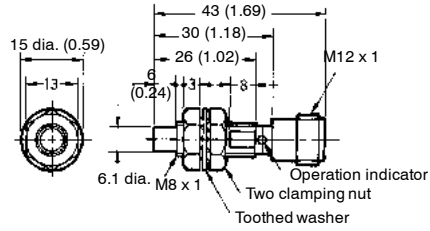

Fig. 11:

E2E-X3D□-M1G-N

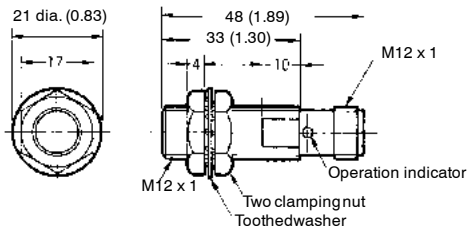
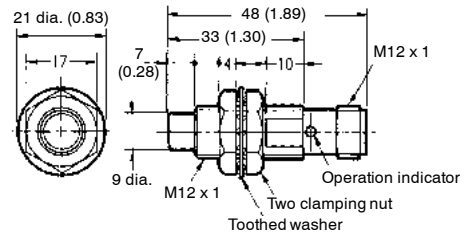

Fig. 12:

E2E-X8MD□-M1G-N



**Connector Models
(Shielded), continued**

Fig. 13 **E2E-X7D□-M1G**

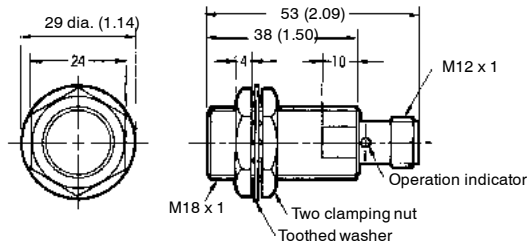

Fig. 14: **E2E-X14MD□-M1G**

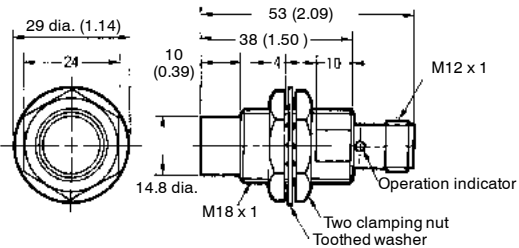

Fig. 15: **E2E-X10D□-M1G**

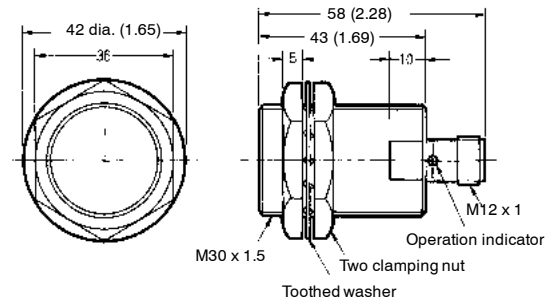
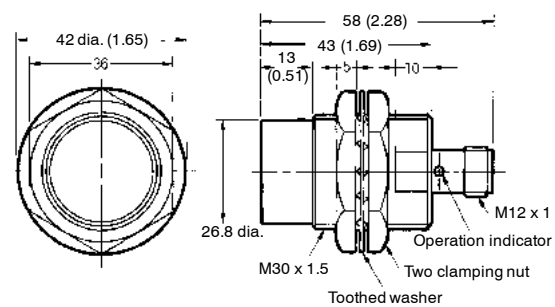
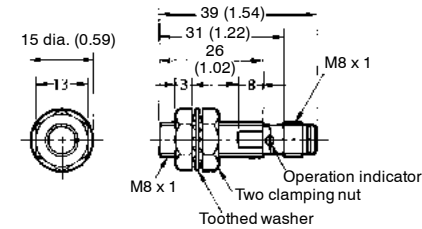

Fig. 16: **E2E-X20MD□-M1G**



**M8 Connector Models
(Shielded)**

Fig. 17: **E2E-X2D□-M3G**



**M8 Connector Models
(Unshielded)**

Fig. 18: **E2E-X4MD□-M3G**

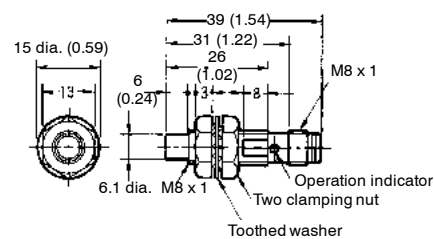

Unit: mm (inch)

■ PIGTAIL CONNECTOR

Fig. 19: E2E-X3D1-M1GJ-N
E2E-X3D1-M1J-T-N

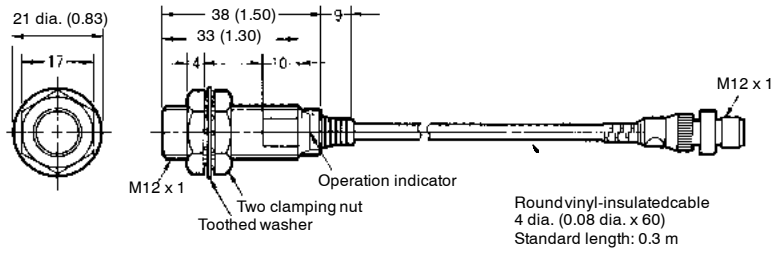

Fig. 20: E2E-X8MD1-M1GJ-N

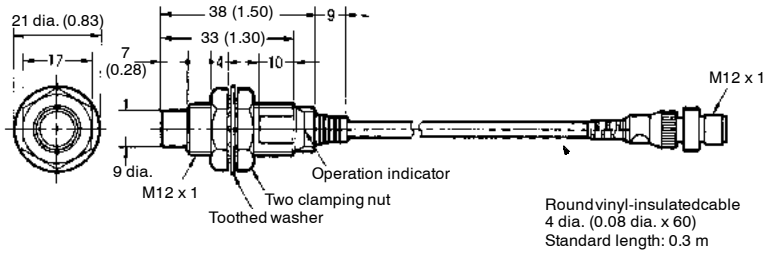

Fig. 21: E2E-X7D1-M1GJ-N
E2E-X7D1-M1J-T-N

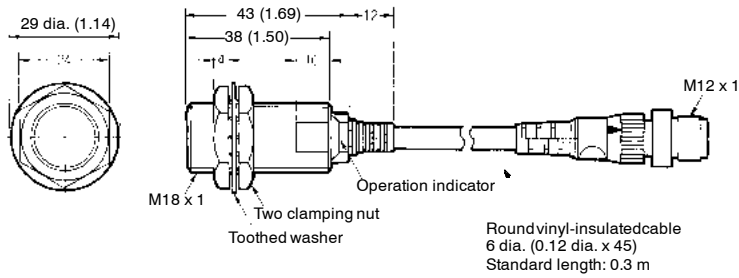
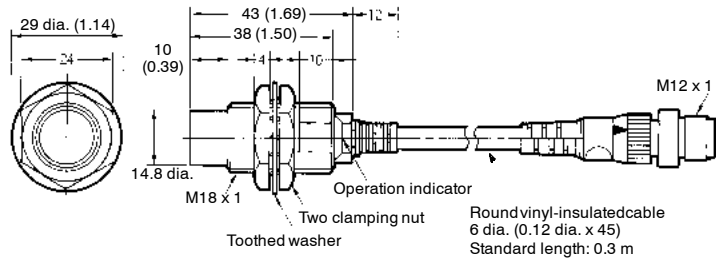

Fig. 22: E2E-X14MD1-M1GJ-N



Pigtail Connector Models, continued

Fig. 23: E2E-X10D1-M1GJ-N
E2E-X10D1-M1J-T-N

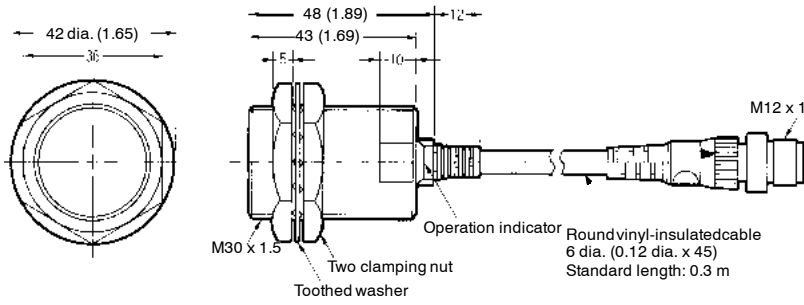
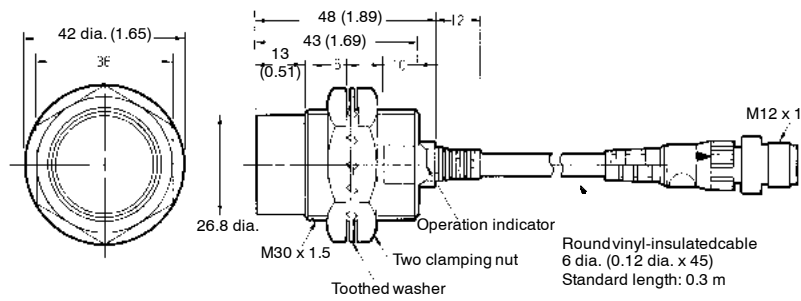

Fig. 24: E2E-X20MD1-M1GJ-N



Mounting Holes

- F -

Dimensions	M8	M12	M18	M30
F (mm)	8.5 ^{+0.5} / ₀ dia.	12.5 ^{+0.5} / ₀ dia.	18.5 ^{+0.5} / ₀ dia.	30.5 ^{+0.5} / ₀ dia.

Connection

PIN ARRANGEMENTS

E2E-X□D□-M□-N DC 2-wire Models

Connector	Self-diagnostic output	Output configuration	Applicable models	Pin arrangement	
M12 Micro Change®	No	NO	E2E-X□D1-M1G□-N (See Note.)	<p>Note: Terminals 2 and 3 are not used.</p>	
			E2E-X□D1-M1J-T-N	<p>Note: 1. Terminals 1 and 2 are not used. 2. Terminals 3 and 4 have no polarity.</p>	
			E2E-X□D1-M1-N	<p>Note: Terminals 1 and 2 are not used.</p>	
	Yes	NO	NC	E2E-X□D2-M1G-N (See Note.)	<p>Note: Terminals 3 and 4 are not used.</p>
				E2E-X□D2-M1-N	<p>Note: Terminals 1 and 4 are not used.</p>
				E2E-X□D1S-M1-N	<p>(Control output)</p> <p>Note: Terminal 1 is not used.</p>

Note: Pin arrangements conform to IEC standards.

(This table continues on the next page.)

■ PIN ARRANGEMENT (CONTINUED)

Connector	Self-diagnostic output	Output configuration	Applicable models	Pin arrangement
M8 Nano Change®	No	NO	E2E-X□D1-M3G-N	<p>Note: Terminals 2 and 3 are not used.</p>
		NC	E2E-X□D2-M3G-N	<p>Note: Terminals 3 and 4 are not used.</p>

Precautions

■ MOUNTING

Do not tighten the nut with excessive force. A washer must be used with the nut.

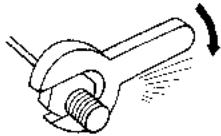

Type		Part A		Part B
		Length	Torque	Torque
M8	Shielded	9 mm	9 N • m (90 kgf • cm)	12 N • m (120 kgf • cm)
	Unshielded	3 mm		
M12		30 N • m (310 kgf • cm)		
M18		70 N • m (710 kgf • cm)		
M30		180 N • m (1,800 kgf • cm)		

Shielded Model

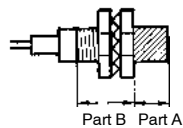

Unshielded Model

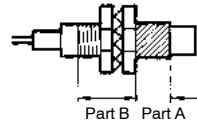

Note: The table above right shows the tightening torques for part A and part B nuts. In the previous examples, the nut is on the sensor head side (part B) and hence the tightening torque for part B applies. If this nut is in part A, the tightening torque for part A applies instead.

■ EFFECTS OF SURROUNDING METAL

When mounting the E2E within a metal panel, ensure that the clearances given in the following table are maintained. Failure to maintain these distances may cause deterioration in the performance of the sensor.

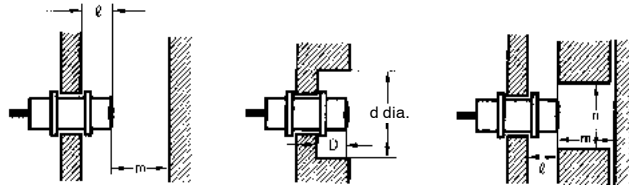

Type		Dimension	M8	M12	M18	M30
E2E-X□D□-N DC 2-wire	Shielded	ℓ	0 mm	0 mm	0 mm	0 mm
		d	8 mm	12 mm	18 mm	30 mm
		D	0 mm	0 mm	0 mm	0 mm
		m	4.5 mm	8 mm	20 mm	40 mm
		n	12 mm	18 mm	27 mm	45 mm
	Unshielded	ℓ	12 mm	15 mm	22 mm	30 mm
		d	24 mm	40 mm	70 mm	90 mm
		D	12 mm	15 mm	22 mm	30 mm
		m	8 mm	20 mm	40 mm	70 mm
		n	24 mm	40 mm	70 mm	90 mm

■ MUTUAL INTERFERENCE

When installing two or more Sensors face to face or side by side, ensure that the minimum distances given in the following table are maintained.

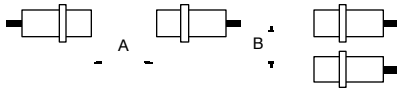

Type		Dimension	M8	M12	M18	M30
E2E-X□D□-N DC 2-wire	Shielded	A	20 mm	30 (20) mm	50 (30) mm	100 (50) mm
		B	15 mm	20 (12) mm	35 (18) mm	70 (35) mm
	Unshielded	A	80 mm	120 (60) mm	200 (100) mm	300 (100) mm
		B	60 mm	100 (50) mm	110 (60) mm	200 (100) mm

Note: The figures in parentheses refer to Sensors operating at different frequencies.

■ INSTALLATION

Power Reset Time

The Proximity Sensor is ready to operate within 100 ms after power is supplied. If power supplies are connected to the Proximity Sensor and load respectively, be sure to supply power to the Proximity Sensor before supplying power to the load.

Power OFF

The Proximity Sensor may output a pulse signal when it is turned off. Therefore, it is recommended to turn off the load before turning off the Proximity Sensor.

Power Supply Transformer

When using a DC power supply, make sure that the DC power supply has an insulated transformer. Do not use a DC power supply with an auto-transformer.

Sensing Object

Metal Coating:

The sensing distances of the Proximity Sensor vary with the metal coating on sensing objects.

■ WIRING

High-tension Lines

Wiring through Metal Conduit

If there is a power or high-tension line near the cable of the Proximity Sensor, wire the cable through an independent metal conduit to prevent against Proximity Sensor damage or malfunctioning.

■ CONNECTING LOAD TO DC 2-WIRE SENSOR

Refer to the following before using AC or DC 2-wire Proximity Sensors.

Surge Protection

Although the Proximity Sensor has a surge absorption circuit, if there is any machine that has a large surge current (e.g., a motor or welding machine) near the Proximity Sensor, connect a surge absorber to the machine.

Leakage Current

When it is OFF, the Proximity Sensor has leakage current. Refer to Leakage Current Characteristics. In this case, the load is imposed with a small voltage and the load may not be reset. Before using the Proximity Sensor, make sure that this voltage is less than the load reset voltage.

Countermeasures Against Leakage Current

DC 2-wire Models

Connect a bleeder resistor as the bypass for the leakage current so that the current flowing into the load will be less than the load reset current.

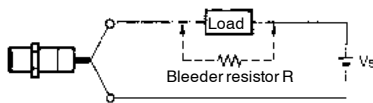

Cable Tractive Force

Do not pull cable with the tractive forces exceeding the following.

Diameter	Tractive force
4 mm dia. max.	30 N max.
4 mm dia. min.	50 N max.

■ MOUNTING

The Proximity Sensor must not be subjected to excessive shock with a hammer when it is installed, otherwise the Proximity Sensor may be damaged or lose its water-resistance.

■ ENVIRONMENT

Water Resistance

Do not use the Proximity Sensor underwater, outdoors, or in the rain.

Operating Environment

Use the Proximity Sensor within its operating ambient temperature range and do not use the Proximity Sensor outdoors, in order to maintain its reliability and life expectancy. Although the Proximity Sensor is water resistant, a cover to protect the Proximity Sensor from water or water soluble machining oil is recommended to maintain its reliability and life expectancy. Do not use the Proximity Sensor in an environment with chemical gas (e.g., strong alkaline or acid gasses including nitric, chromic, and concentrated sulfuric acid gasses).

Refer to the following to calculate the bleeder resistance and the allowable power of the bleeder resistor.

$$R \leq V_S / (i_R - i_{OFF}) \text{ (k}\Omega\text{)}$$

$$P > V_S^2 / R \text{ (mW)}$$

P: The allowable power of the bleeder resistor. (The actual power capacity of the bleeder resistor must be at least a few times as large as the allowable power of the bleeder resistor.)

i_R : Leakage current of Sensors (mA)

i_{OFF} : Release current of load (mA)

The following resistors are recommended.

12 VDC (supply voltage): A resistor with a resistance of 15 k Ω maximum and an allowable power of 450 mW minimum
 24 VDC (supply voltage): A resistor with a resistance of 30 k Ω maximum and an allowable power of 0.1 W minimum

Inrush Current

A load that has a large inrush current (e.g., a lamp or motor) will damage the Proximity Sensor, in which case connect the load to the Proximity Sensor through a relay.

NOTE: DIMENSIONS SHOWN ARE IN MILLIMETERS. To convert millimeters to inches divide by 25.4.

OMRON[®]

OMRON ELECTRONICS LLC

One East Commerce Drive
Schaumburg, IL 60173

1-800-55-OMRON

OMRON ON-LINE

Global - <http://www.omron.com>
USA - <http://www.omron.com/oei>
Canada - <http://www.omron.com/oci>

OMRON CANADA, INC.

885 Milner Avenue
Scarborough, Ontario M1B 5V8

416-286-6465