

High Precision, 2-color Display Digital Pressure Switch *Series ZSE30/ISE30*



- ZSE□
ISE□
- PSE
- ZSE3
- PS
- ZSE¹₂
- ZSP
- ISA2
- IS□
- ZSM
- PF2□
- IF□
- Data

With One-touch fittings
are newly introduced.



Straight type



Elbow type

2-color digital display allows you to choose the setting according to your application requirements. 4 different display settings are available.

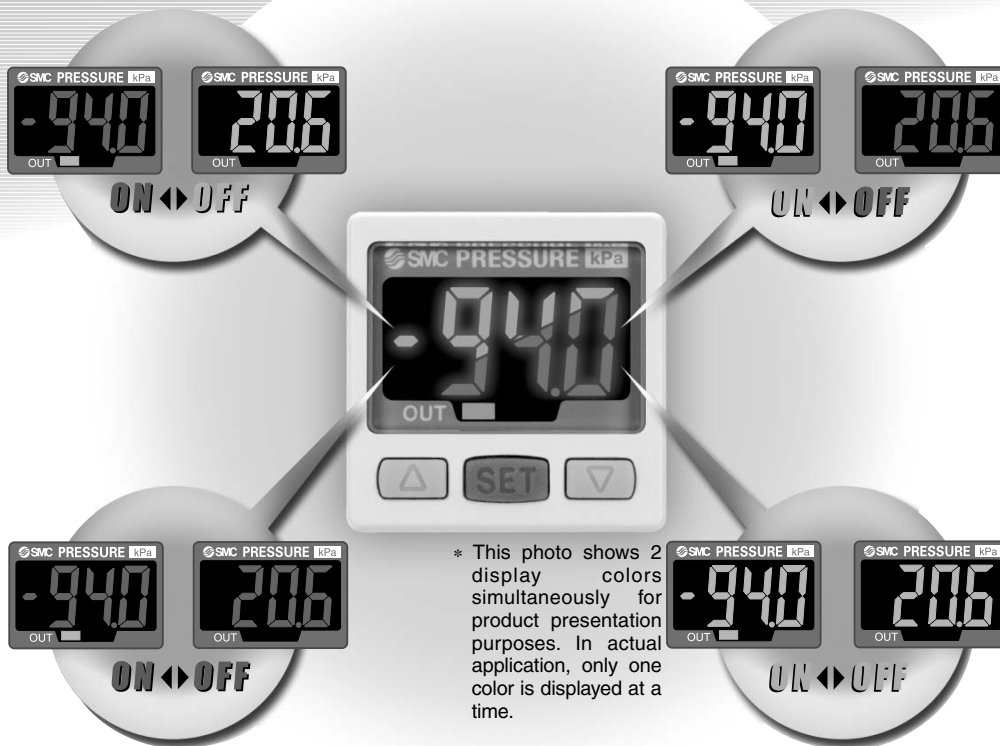

Abnormal conditions can be detected at a glance!

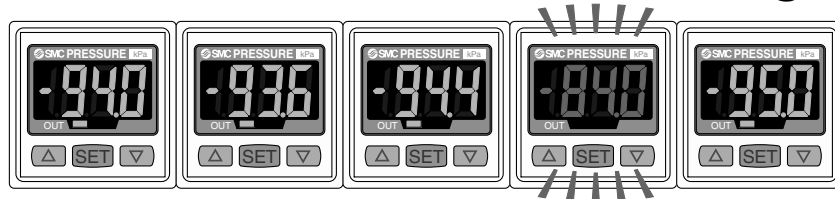

With One-touch fitting ($\varnothing 4, \varnothing 6, \varnothing 5/32", \varnothing 1/4"$)

Reduced dimensions in piping direction

17.8 mm reduction*

Straight type

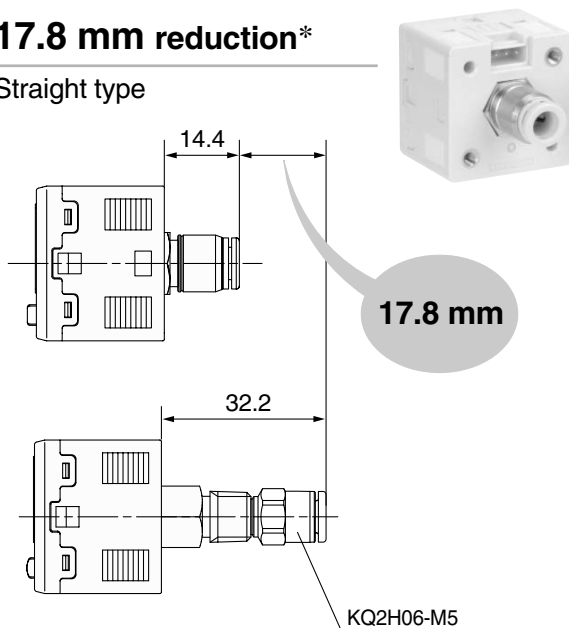

12.4 mm reduction*

Elbow type

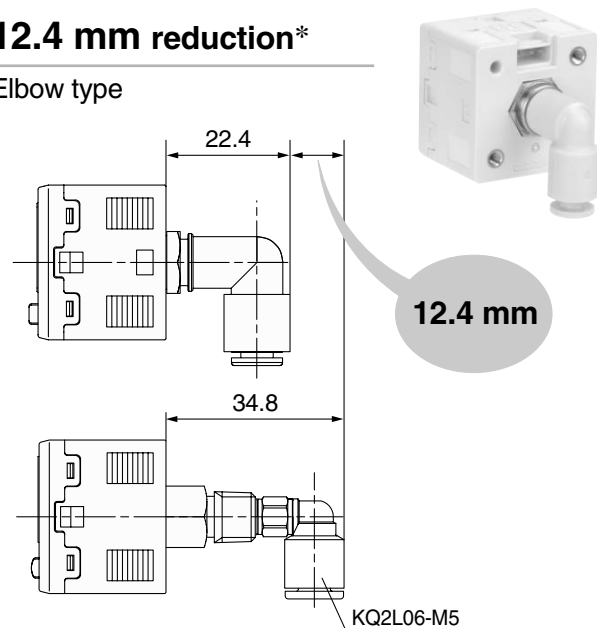

* Comparison when One-touch fittings (KQ2H06-M5 / KQ2L06-M5) are connected to the piping ports (M5 x 0.8)

Space-saving improvement

Economical use of space

Old Model

ZSE4E
ISE4E

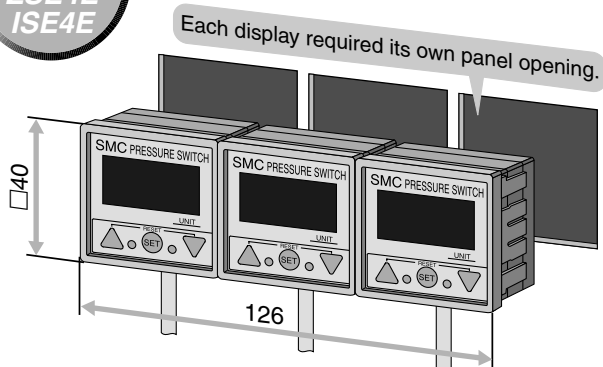

New Model

ZSE30
ISE30

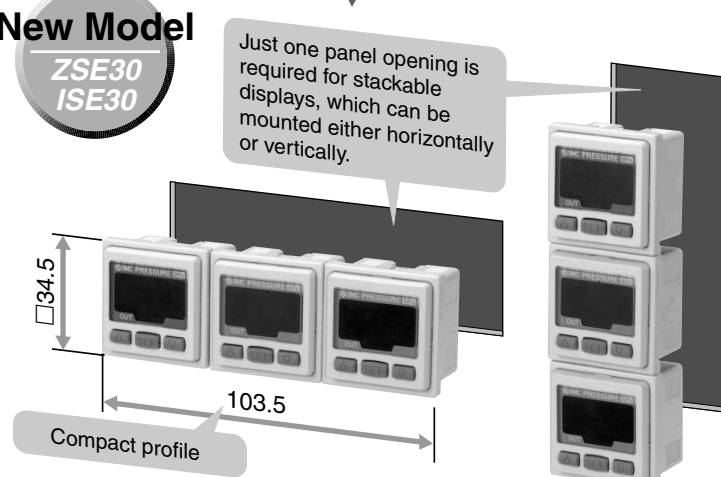

Applicable panel thickness is up to 6 mm.

(Panel mounting)

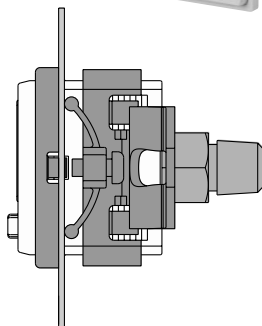

With analog output

In addition to the conventional voltage output type (1 to 5 V)

Current output type (4 to 20 mA)

is now available.

- Convenient when longer wiring is required
- Excellent noise resistance

Switches for vacuum and positive pressure can be easily distinguished.

The different display panel frame colors easily tell them apart.

Vacuum/Low pressure (ZSE30)

Blue



Positive pressure (ISE30)

Gray



Display calibration

Old Model

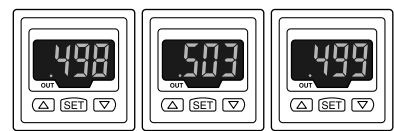

New Model

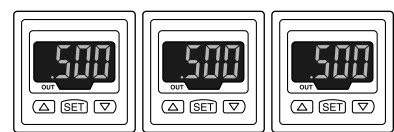

This function allows uniformity in the numbers displayed.

More user-friendly controls

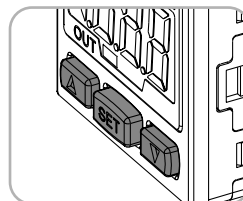

Raised rubber button controls are clearly set apart, simple to operate, soft to the touch.

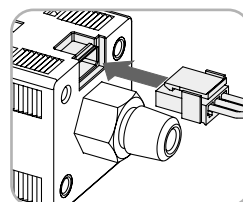

Plug-type connectors take the burden out of wiring work and maintenance.

High-precision

resolution: 1/1000

Variations

	Vacuum/Low pressure ZSE30	Positive pressure ISE30
Rated pressure range	100 kPa 0 -100 kPa	1 MPa 0
Setting/Display resolution	0.2 kPa	0.001 MPa
Output	Switch output Analog output	NPN/PNP open collector (1 output) Voltage output: 1 to 5 V; Current output: 4 to 20 mA
Current consumption	45 mA or less (70 mA or less for current output)	
Option	Panel mount/Bracket	

ZSE□
ISE□

PSE

ZSE3

PS

ZSE₁
ISE₂

ZSP

ISA2

IS□

ZSM

PF2□

IF□

Data

High Precision, 2-color Display Digital Pressure Switch Series **ZSE30/ISE30**

How to Order

For positive pressure

ISE30 — **01** — **25** — **M** — [] — []

For vacuum/low pressure

ZSE30 — **01** — **25** — **M** — [] — []

Piping specifications

01	R 1/8 (With M5 female thread)	
T1	NPT 1/8 (With M5 female thread)	
C4H	ø4 One-touch fitting ø5/32" One-touch fitting	Straight type
C6H	ø6 One-touch fitting	
N7H	ø1/4" One-touch fitting	Elbow type
C4L	ø4 One-touch fitting ø5/32" One-touch fitting	
C6L	ø6 One-touch fitting	
N7L	ø1/4" One-touch fitting	

Output specifications

25	NPN output
65	PNP output
26	1 to 5 V output
28	4 to 20 mA output

Option 1

Nil	Without lead wire
L	Lead wire with connector (Lead wire length: 2 m)

Option 2

Nil	None
A	Bracket
B	Panel mount
D	Panel mount adapter + Front protective cover

Option Part No.

When optional parts are required separately, use the following part numbers to place an order.

Option	Part no.	Note
Lead wire with connector	ZS-27-A	Lead wire length: 2 m
Bracket	ZS-27-B	With mounting screws (M3 x 5L: 2 pcs.)
Panel mount adapter	ZS-27-C	With M3 x 8L (2 pcs.)
Panel mount adapter + Front protective cover	ZS-27-D	With M3 x 8L (2 pcs.)

Unit specifications

Nil	With unit switching function
M	Fixed SI unit (International System of Units) ^{Note)}

Note) Fixed unit:
For vacuum/Low pressure: kPa
For positive pressure: MPa

High Precision, 2-color Display Digital Pressure Switch **Series ZSE30/ISE30**

Specifications



		ZSE30 (Vacuum/Low pressure)	ISE30 (Positive pressure)
Rated pressure range		-100.0 to 100.0 kPa	0.000 to 1.000 MPa
Regulating pressure range		-101.0 to 101.0 kPa	-0.100 to 1.000 MPa
Proof pressure		500 kPa	1.5 MPa
Min. regulating unit		0.2 kPa	0.001 MPa
Fluid		Air, Inert gas, Non-flammable gas	
Power supply voltage		12 to 24 VDC, Ripple (p-p) 10% or less (With power supply polarity protection)	
Current consumption		45 mA or less (at no load)	
Switch output ^{Note 1)}		NPN or PNP open collector output: 1 output	
Max. load current		80 mA	
Max. applied voltage		30 V (With NPN output)	
Residual voltage		1 V or less (With load current of 80 mA)	
Response time		2.5 ms or less (Response time selections with anti-chattering function: 20, 160, 640, 1280 ms)	
Short circuit protection		Yes	
Repeatability		±0.2% F.S. ±2 digit or less	±0.2% F.S. ±1 digit or less
Analog output	Voltage output ^{Note 2)}	Output voltage: 1 to 5 V ±2.5% F.S. or less (With rated pressure range) Linearity: ±1% F.S. or less, Output impedance: Approx. 1 kΩ	
	Current output ^{Note 3)}	Output current: 4 to 20 mA ±2.5% F.S. or less (With rated pressure range) Linearity: ±1% F.S. or less Maximum load impedance: 300 Ω with power supply voltage of 12 V; 600 Ω with power supply voltage of 24 V Minimum load impedance: 50 Ω	
Hysteresis	Hysteresis mode	Adjustable (can be set from 0)	
	Window comparator mode		
Display		3 1/2 digit, 7-segment indicator, 2-color display (Red and green) Sampling cycle: 5 times/s	
Display accuracy		±2% F.S. ±2 digit (at 25°C ambient temperature)	±2% F.S. ±1 digit (at 25°C ambient temperature)
Indicator light		Light up when output is ON (Green)	
Temperature characteristics		±2% F.S. or less (based on 25°C)	
Environmental resistance	Enclosure	IP40	
	Operating temperature range	Operating: 0 to 50°C, Stored: -10 to 60°C (No freezing or condensation)	
	Operating humidity range	Operating and stored: 35 to 85% RH (No condensation)	
	Withstand voltage	1000 VAC for 1 min. between live parts and enclosure	
	Insulation resistance	50 MΩ or more between live parts and enclosure (at 500 VDC)	
	Vibration resistance	10 to 150 Hz, 1.5 mm or 20 m/s ² amplitude in X, Y, Z directions for 2 hours each	
Impact resistance		100 m/s ² in X, Y, Z directions 3 times each	
Standard		Compliant with CE Marking and UL (CSA) standards	

Note 1) When switch output is selected, analog output is not available.

Note 2) When voltage output is selected, a simultaneous selection of switch output and current output is not available.

Note 3) When current output is selected, a simultaneous selection of switch output and voltage output is not available.

Piping Specifications

Part		01	T1	C4H	C6H	N7H	C4L	C6L	N7L
Port size	One-touch fitting Straight type	R 1/8 M5 x 0.8	NPT 1/8 M5 x 0.8	—	—	—	—	—	—
	One-touch fitting Elbow type	—	—	ø4 mm ø5/32 inch	ø6 mm	ø1/4 inch	—	—	—
Wetted part material		Sensor pressure receiving area: Silicon, Piping port: C3602 (Electroless nickel plated), O-ring: HNBR							
					O-ring: NBR		O-ring: NBR, fitting: PBT		
Weight	With lead wire with connector (2 m)	81 g		76 g		78 g			
	Without lead wire with connector	43 g		38 g		40 g			

ZSE□
ISE□

PSE

ZSE3

PS

ZSE₁²

ZSP

ISA2

IS□

ZSM

PF2□

IF□

Data

Series ZSE30/ISE30

Setting

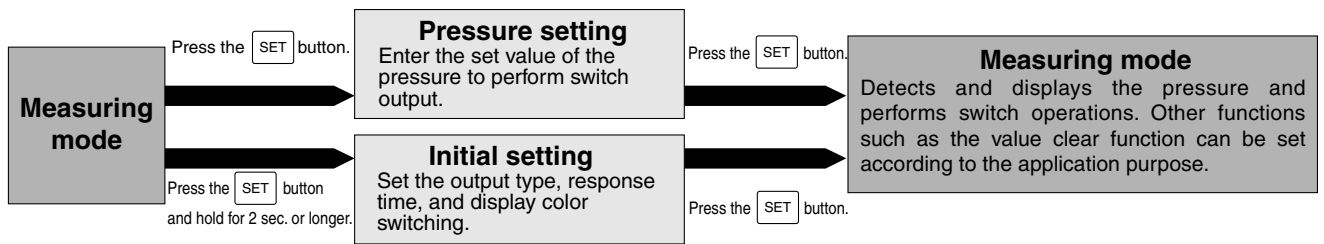

Initial Setting

Initial setting mode

Press and hold the SET button for 2 seconds or longer. Display monitor will be per Figure A below, and the switch will now be in the display color setting mode.

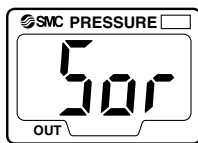
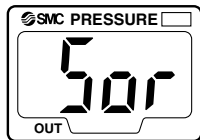

Figure A

If the unit specification indicated at the time of ordering is "M", the fixed SI unit will be used. If it is Nil, refer to "Unit Switching Function" on page 16-2-8.

1. Display color setting

Select the color for LCD display. Press the Δ UP or ∇ DOWN button to choose a display color.



ON: Red

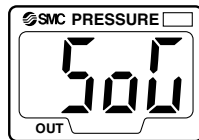

ON: Green

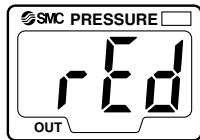

ON/OFF: Red

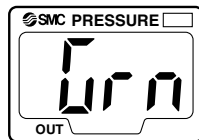

ON/OFF: Green

Press the SET button to set the color and proceed to the operating mode setting.

If the analog output is set, press the Δ UP or ∇ DOWN button and select the desired display color from Grn (Green) or rEd (Red). Press the SET button to exit this mode and return to the measuring mode.

2. Operating mode setting

This mode will let you select the switch operating mode. While the current operating mode is displayed, press the Δ UP or ∇ DOWN button to select a newly desired operating



Hysteresis mode

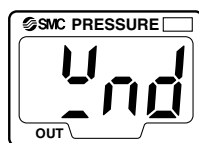

Window comparator mode

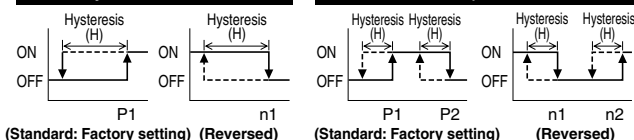

(Standard: Factory setting) (Reversed) (Standard: Factory setting) (Reversed)

Press the SET button to set the mode and proceed to the output type setting.

3. Output type setting

The type of switch output can be set arbitrarily. While the current output type is displayed, press the ∇ DOWN button to switch between normally open nO and normally closed nL .

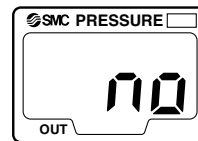

Normally open

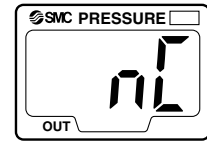

Normally closed

Press the SET button to set the output type and proceed to the response time setting.

4. Response time setting

The switch output response time can be set arbitrarily. Chattering can be prevented with a response time setting. While the current response time is displayed, press the Δ UP or ∇ DOWN button to select a new response time.



2.5 ms



20 ms



160 ms

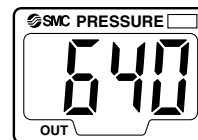

640 ms



1280 ms

Press the SET button to set the response time and proceed to the auto preset setting.

If the operating mode is the window comparator mode, press the SET button to return to the measuring mode.

5. Auto preset setting

This function stores the measuring pressure that is set during the auto preset mode as a basic value.

While the current setting is displayed, press the Δ UP or ∇ DOWN button to select it as an auto preset setting.

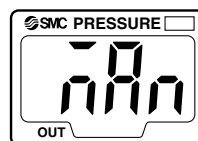

Manual

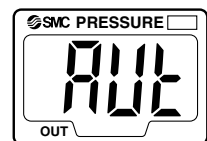

Auto

Press the SET button to set the auto preset and return to the measuring mode.

Pressure setting

Manual setting

Press the SET button in the measuring mode to display the set value. P_1 and the current set value blink alternately.

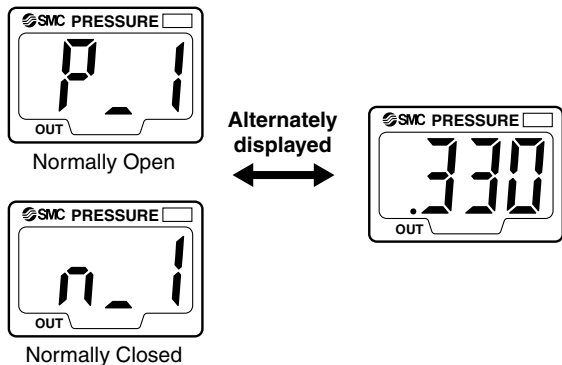

Press the SET button to display the next set value. Press the Δ UP or ∇ DOWN button to change the value. (Refer to "How to Set Value" on the lower right hand corner of this page.)

Hysteresis mode

In this mode, hysteresis (H) and the set value for hysteresis are displayed alternately after setting P1. Press the SET button to return to the normal measuring mode. Press the Δ UP or ∇ DOWN button to change the value. (Refer to "How to Set Value" below right.)

Window comparator mode

In this mode, P2 and the current set value are displayed alternately after setting P1. Press the SET button to display the next set value (H: hysteresis). Press the Δ UP or ∇ DOWN button to change the value. (Refer to "How to Set Value" at right.)

Next, H and the set value for hysteresis will be displayed alternately. Press the SET button to return to the normal measuring mode. Press the Δ UP or ∇ DOWN button to change the value. (Refer to "How to Set Value" at right.)

Pressure set value can be verified without holding or stopping the switch output operation.

Auto preset setting

1. Auto preset preparation mode

While in the measuring mode, press the SET button to activate the auto preset preparation mode, and $AP1$ will be displayed. Proceed to prepare the devices to perform the pressure setting. While $AP1$ is still displayed, press both the Δ UP and ∇ DOWN buttons simultaneously to return to the measuring mode.

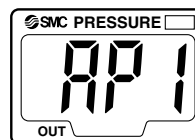

2. Auto preset setting

Press the SET button to activate the mode to execute auto preset functions. When AL is displayed, start the system operation and change the pressure. The set value will be automatically detected and stored.

While AL is still displayed, press the SET button to complete the setting and return to the normal measuring mode.

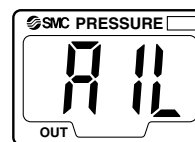

How to Set Value

To enter a value such as the one for pressure setting:

1. Press the Δ UP or ∇ DOWN button to change the set value. The first digit blinks.



1st digit

2. Press the Δ UP or ∇ DOWN button to set the value arbitrarily. (If there is no button operation for more than 10 seconds, the current value will be automatically set and the function will return to the set value display mode.)

3. With every push of the SET button, the next (higher) digit blinks.



2nd digit



3rd digit

When the left-most digit is zero, "i" or "j" will blink. If the SET button is pressed while the left-most digit is blinking, the right-most digit will now blink.



4. Press and hold the SET button for 1 second or longer to return to the set value display mode.

ZSE□
ISE□

PSE

ZSE3

PS

ZSE1

ZSP

ISA2

IS□

ZSM

PF2□

IF□

Data

Series ZSE30/ISE30

Setting

Function setting

Display calibration

During measuring mode, press the SET and ∇ DOWN buttons simultaneously and hold for 2 seconds or longer. F5L and current measured value will be displayed.

Press the Δ UP or ∇ DOWN button to change the set value. If there is no button operation for more than 2 seconds after changing the set value, the display mode returns to displaying F5L and the current measured value.

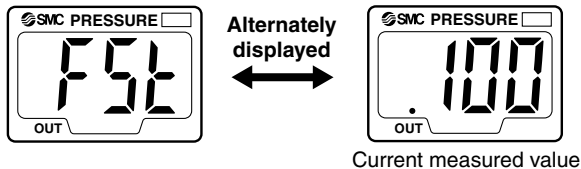

Press the SET button to display the adjusted value (percent). The adjusted value and F5L will be alternately displayed.

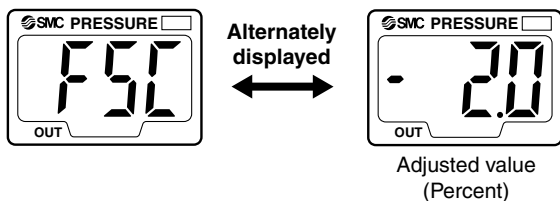

Press the SET button to return to the normal measuring mode.

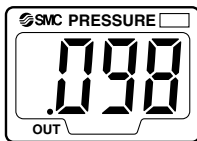

This function eliminates slight differences in the output values and allows uniformity in the numbers displayed. Displayed values of the pressure sensor can be calibrated to within $\pm 5\%$ for Series ISE and $\pm 2.5\%$ for Series ZSE.

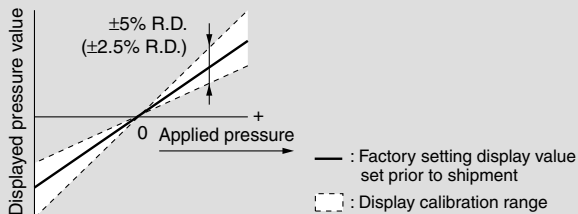

Note) When the display calibration function is used, the regulating pressure value may change ± 1 digit.

Peak/Bottom hold function

This function constantly detects and updates the maximum and minimum pressure values and allows to hold the display value.

To use a peak hold function, press and hold the Δ UP button for 1 second or longer. The maximum pressure value is held and blinks repeatedly. Press and hold the Δ UP button again for 1 second or longer to release this function and return to the measuring mode.

To use a bottom hold function, press the ∇ DOWN button for 1 second or longer. The minimum pressure value is held and blinks repeatedly. Press and hold ∇ DOWN button again for 1 second or longer to release this function and return to the measuring mode.

Key lock function

This function prevents incorrect operations such as changing the set value accidentally. Press the SET button and hold for 4 seconds or longer to display the current Loc or Unl setting. Press the Δ UP or ∇ DOWN button to select the setting and set this function with the SET button. Use the Loc mode to avoid accidental button operation. To release a key lock function, press the SET button and hold for 4 seconds or longer to display the current setting, and select the Unl mode.

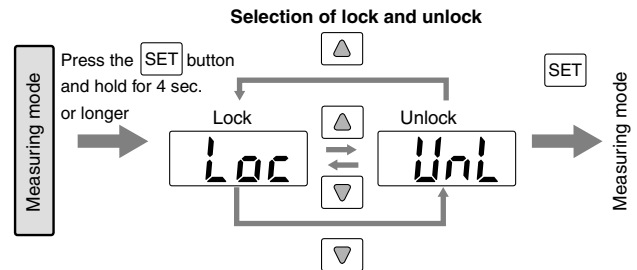

Zero out (Zero ADJ) function

This function clears and resets the displayed value as long as the measuring pressure is within ± 70 digits of the atmospheric pressure.

(Due to individual product differences, the setting range varies $\pm 10\%$ F.S.)

This function is effective in detecting pressure fluctuations that exceed a certain amount without being affected by the supply pressure. Press and hold the Δ UP and ∇ DOWN buttons simultaneously to reset the display. Release the buttons to return to the measuring mode.

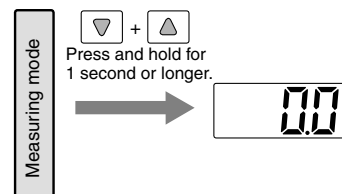

Unit Conversion Function

When not selecting "M" for unit specification

Desired display unit can be selected.

Press the Δ UP or ∇ DOWN button to switch the unit, and the set value is automatically converted.

The conversion order is: Pa \leftrightarrow kgf/cm² \leftrightarrow bar \leftrightarrow psi \leftrightarrow inchHg \leftrightarrow mmHg

Press the SET button to set the unit and proceed to the display color setting.

For vacuum/low pressure Pa \leftrightarrow kgf/cm² \leftrightarrow bar \leftrightarrow psi \leftrightarrow inchHg \leftrightarrow mmHg

For positive pressure MPa \leftrightarrow kgf/cm² \leftrightarrow bar \leftrightarrow psi

Indication of Units

Displayed unit	ISE30	ZSE30
Pa	0.001 MPa	0.2 kPa
kgf/cm ²	0.01	0.002
bar	0.01	0.002
psi	0.2	0.05
mmHg	—	2
inchHg	—	0.2

High Precision, 2-color Display Digital Pressure Switch Series ZSE30/ISE30

Description

Indication light (Green)
Displays the switch operation status.

▲UP button
Use this button to change the mode or increase the ON/OFF set value. It also allows you to switch to the peak value display mode.

SET button
Use this button to switch the mode and set the set value.

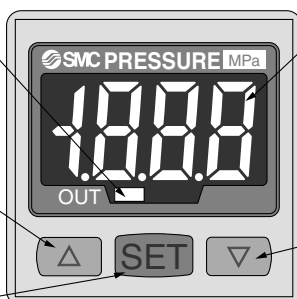

LCD display
Displays the current pressure condition, setting mode conditions, selected display unit, and error codes. A display color type can be selected from either a single color display with red or green, or 2-color display in which green and red are switched according to the output.

▼DOWN button
Use this button to change the mode or decrease the ON/OFF set value. It also allows you to switch to the bottom value display mode.

Error Correction

Take the following corrective solutions when errors occur.

Error description	LCD display	Condition	Solution
over-current error	Er 1	Load current of switch output is more than 80 mA.	Shut off the power supply. After eliminating the output factor that caused the excess current, turn the power supply back on.
Residual pressure error	Er 3	Pressure is applied during the zero out operation as follows: When the switch for positive pressure is used: ± 0.071 MPa or more. When the switch positive pressure is used: ± 7.1 kPa or more. After displaying for 3 seconds, it will return to the measuring mode. Due to the individual product difference, the setting range varies $\pm 10\%$ F.S.	Bring the pressure back to atmospheric pressure and try using the zero out function.
Applied pressure error	HHH	Supply pressure exceeds the maximum regulating pressure.	Reduce/increase supply pressure to within the regulating pressure range.
	LLL	Supply pressure is below the minimum regulating pressure.	
System error	Er 4	Internal data error	Shut off the power supply. Turn the power supply back on. If the power should not come back on, please contact SMC for an inspection.
	Er 6	Internal data error	
	Er 7	Internal data error	
	Er 8	Internal data error	

Example of Internal Circuit and Wiring

-25
NPN open collector output
Maximum 30 V, 80 mA
Residual voltage:
1 V or less

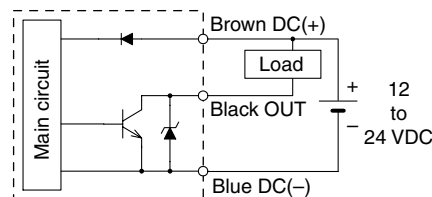

-26
Analog output type
1 to 5 V ($\pm 2.5\%$ F.S.)
Output impedance:
1 k Ω

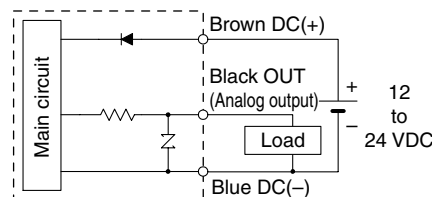

-28
Analog output type
4 to 20 mA ($\pm 2.5\%$ F.S.)
Maximum load impedance:
Power supply voltage 12 V: 300 Ω
Power supply voltage 24 V: 600 Ω
Minimum load impedance: 50 Ω

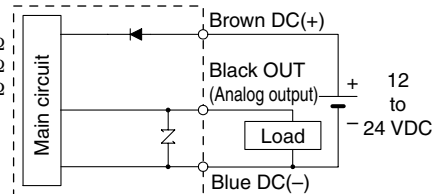

-65
PNP open collector
Maximum 80 mA

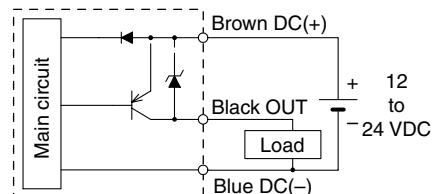

ZSE□
ISE□

PSE

ZSE3

PS

ZSE1

ZSP

ISA2

IS□

ZSM

PF2□

IF□

Data

Series ZSE30/ISE30

Dimensions

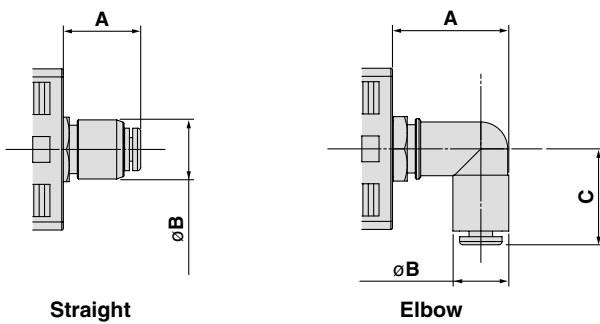
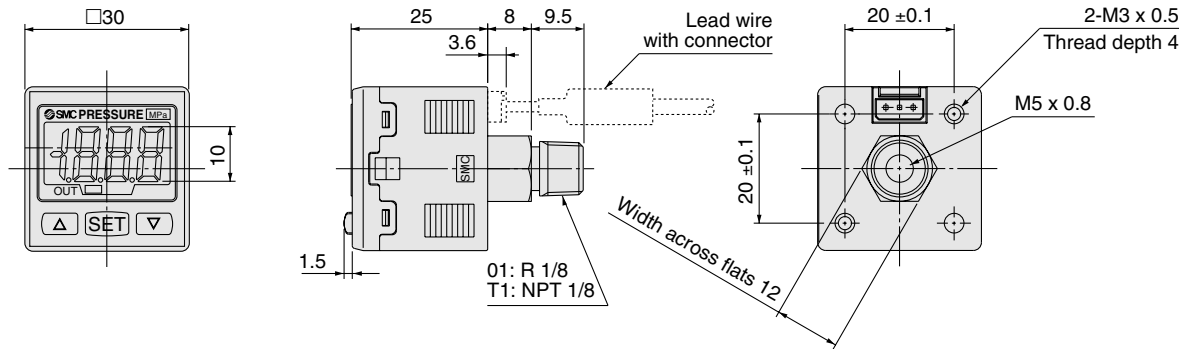

Straight

Elbow

With One-touch fitting

One-touch fitting size	Straight		Elbow		
	A	B	A	B	C
$\varnothing 4, \varnothing 5/32"$	14.4	11.2	20	10.4	18
$\varnothing 6$			22.4	12.8	20
$\varnothing 1/4"$			22.8	13.2	20.5

(mm)

With bracket

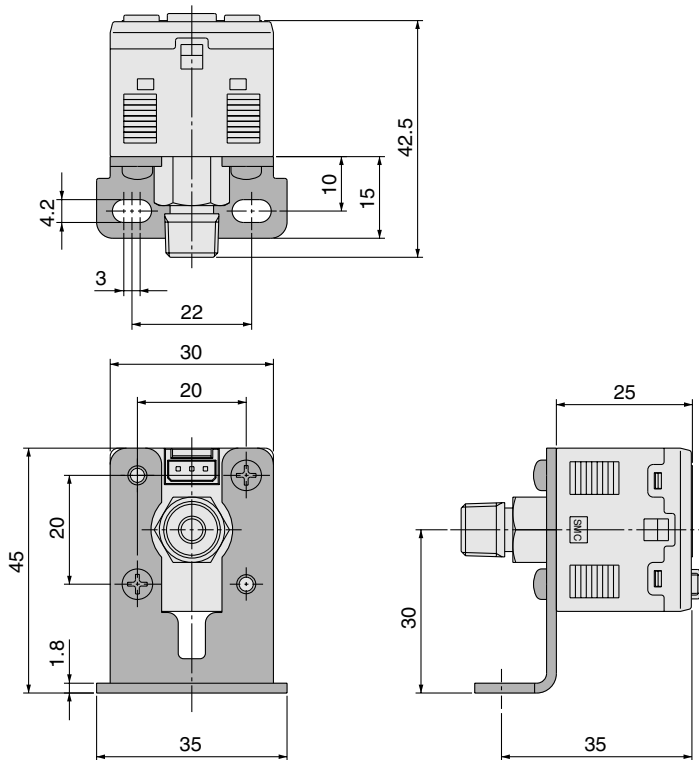

High Precision, 2-color Display Digital Pressure Switch Series ZSE30/ISE30

Dimensions

Panel mount

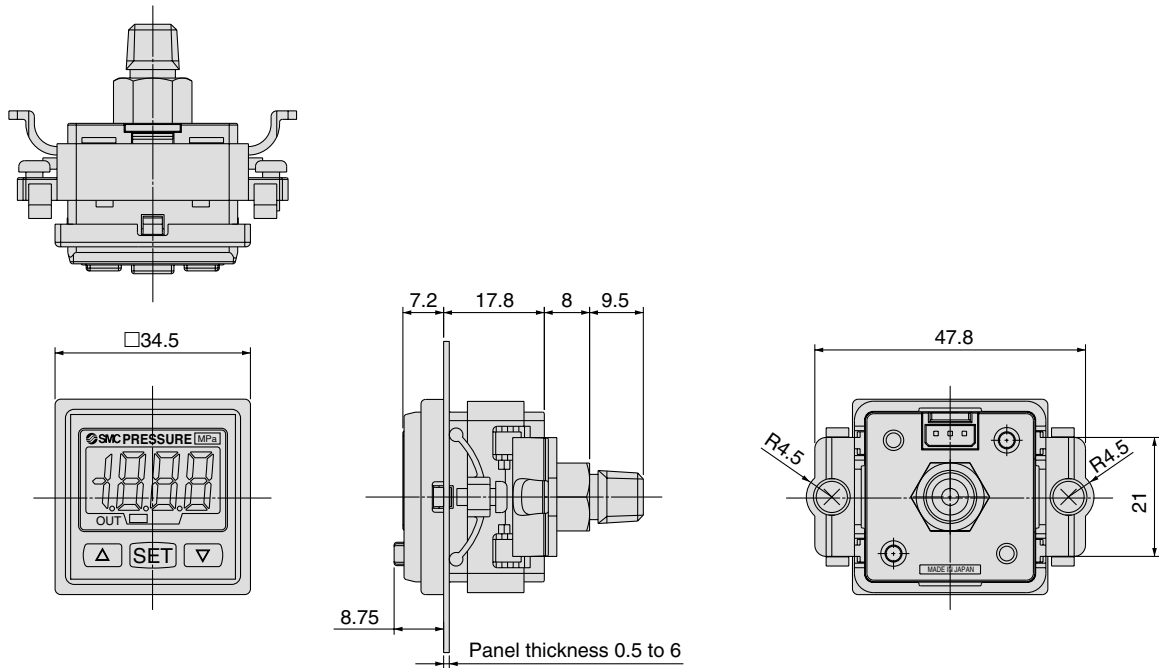

Panel mount adapter + Front protective cover

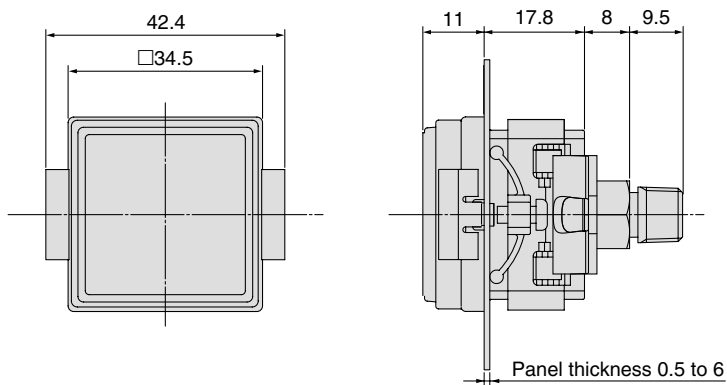

ZSE□
ISE□
PSE
ZSE3
PS
ZSE ₁
ZSE ₂
ZSP
ISA2
IS□
ZSM
PF2□
IF□
Data

Series ZSE30/ISE30

Dimensions

Panel fitting dimension

1-pc. mounting

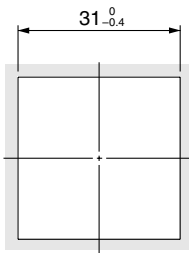

Multiple (2 pcs. or more) horizontal mounting

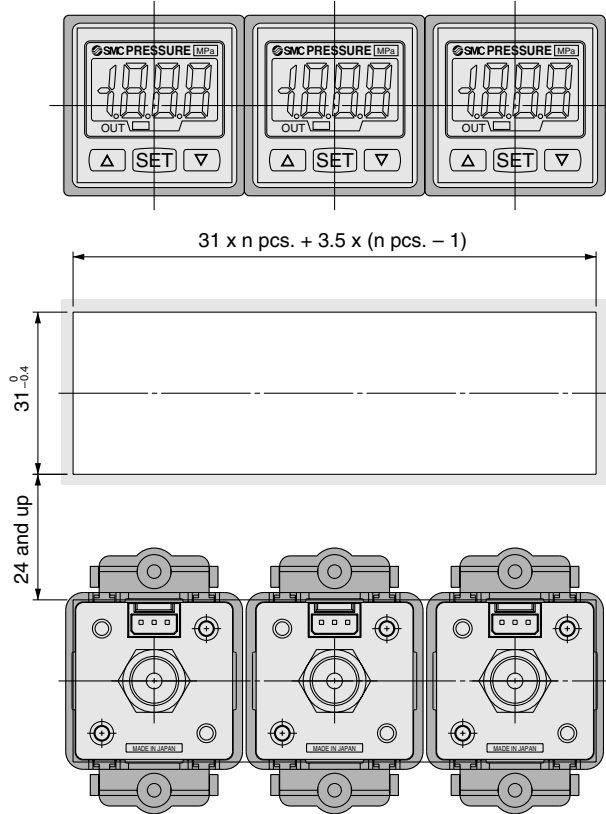

Multiple (2 pcs. or more) vertical mounting

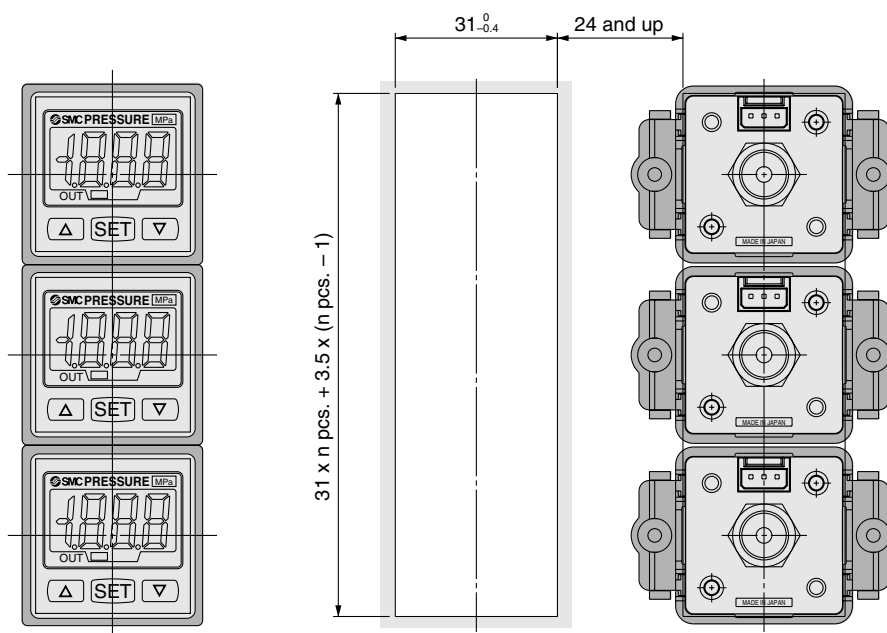



Specific Product Precautions 1

Be sure to read before handling.

Handling

Warning

1. Do not drop, bump, or apply excessive impacts (980 m/s²) while handling. Although the body of the sensor may not be damaged, the internal parts of the sensor could be damaged and lead to a malfunction.
2. The tensile strength of the cord is 35 N. Applying a greater pulling force on it can cause a malfunction. When handling, hold the body of the sensor—do not dangle it from the cord.
3. Do not exceed the screw-in torque of 7 to 9 N·m when installing piping. Exceeding this value may cause malfunctioning of the sensor.
4. Do not use pressure sensors with corrosive and/or flammable gases or liquids.
5. Allow a sufficient margin of tube length in piping in order to prevent application of torsional, tensile or moment load to the tubes and fittings.
6. When a brand of tubing other than SMC is used, make sure that the tolerance of the tube's O.D. satisfies the following specifications.
 - 1) Nylon tubing: ±0.1 mm or less
 - 2) Soft nylon tubing: ±0.1 mm or less
 - 3) Polyurethane tubing: +0.15 mm or less, -0.2 mm or less
7. The applicable fluid is air. Please consult with SMC if the switch is to be used with other types of fluids.

Connection

Warning

1. Incorrect wiring can damage the switch and cause a malfunction or erroneous switch output. Connections should be done while the power is turned off.
2. Do not attempt to insert or pull the pressure sensor or its connector when the power is on. A switch output malfunction may occur.
3. Wire separately from power lines and high voltage lines, avoiding wiring in the same conduit with these lines. Malfunctions may occur due to noise from these other lines.
4. If a commercial switching regulator is used, make sure that the F.G. terminal is grounded.

Operating Environment

Warning

1. Our pressure switches are CE marked; however, they are not equipped with surge protection against lightning. Lightning surge countermeasures should be applied directly to system components as necessary.
2. Our pressure switches do not have an explosion proof rating. Never use in the presence of an explosive gas as this may cause a serious explosion.
3. Do not use in an environment where static electricity can cause problems, otherwise system failure or malfunction may result.

Mounting

Caution

1. Mounting with panel mount adapter

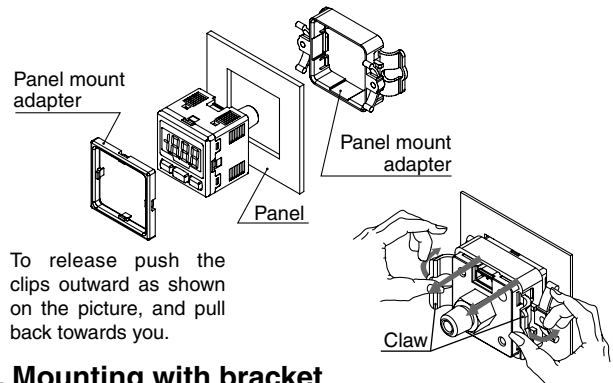

2. Mounting with bracket

Mount a bracket to the body using two M3 x 5L mounting screws and install on piping with hexagon socket head cap screws. The switch can be installed horizontally depending on the installation location.

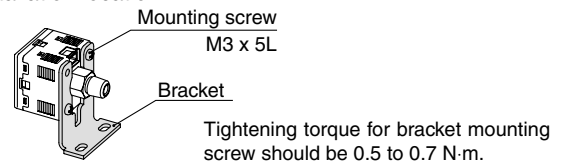

ZSE□
ISE□

PSE

ZSE3
I SE3

PS

ZSE1
I SE2

ZSP

ISA2

IS□

ZSM

PF2□

IF□

Data



Series ZSE30/ISE30

Specific Product Precautions 2

Be sure to read before handling.

Connection/Removal of Connector

- To connect the connector, insert it straight while pinching the lever, and then push the lever into the jack of the housing and lock it.
- To remove the connector, pull it straight out while applying pressure with your thumb to the lever and unhooking it from the jack.

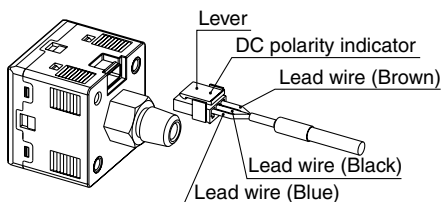

- Do not attempt to insert or pull the pressure sensor or its connector when the power is on. A switch output malfunction may occur.

Piping

- Cut the tube perpendicularly.
- Hold the tube and insert it into the One-touch fitting carefully and securely all the way to the bottom.

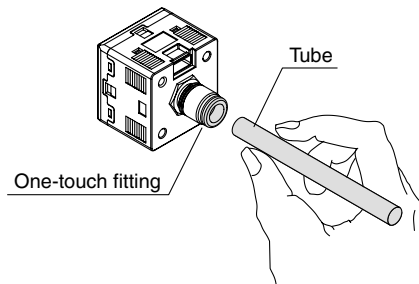

Regulating Pressure Range and Rated Pressure Range

⚠ Caution

Set the pressure within the rated pressure range.

The regulating pressure range is the range of pressure that is possible in setting.

The rated pressure range is the range of pressure that satisfies the specifications (accuracy, linearity, etc.) on the sensor.

Although it is possible to set a value outside the rated pressure range, the specifications will not be guaranteed even if the value stays within the regulating pressure range.

Switch	Pressure range				
	-100 kPa	0	100 kPa	500 kPa	1 MPa
For vacuum/ low pressure	ZSE30	-100 kPa	100 kPa		
		-101 kPa	101 kPa		
For positive pressure	ISE30	0	1 MPa		
		-100 kPa (-0.1 MPa)	1 MPa		

Rated pressure range of switch
 Regulating pressure range of switch



Safety Instructions

These safety instructions are intended to prevent a hazardous situation and/or equipment damage. These instructions indicate the level of potential hazard by labels of "Caution", "Warning" or "Danger". To ensure safety, be sure to observe ISO 4414 ^{Note 1)}, JIS B 8370 ^{Note 2)} and other safety practices.

 **Caution** : Operator error could result in injury or equipment damage.

 **Warning** : Operator error could result in serious injury or loss of life.

 **Danger** : In extreme conditions, there is a possible result of serious injury or loss of life.

Note 1) ISO 4414: Pneumatic fluid power--General rules relating to systems.

Note 2) JIS B 8370: General Rules for Pneumatic Equipment

Warning

1. The compatibility of pneumatic equipment is the responsibility of the person who designs the pneumatic system or decides its specifications.

Since the products specified here are used in various operating conditions, their compatibility for the specific pneumatic system must be based on specifications or after analysis and/or tests to meet your specific requirements. The expected performance and safety assurance will be the responsibility of the person who has determined the compatibility of the system. This person should continuously review the suitability of all items specified, referring to the latest catalog information with a view to giving due consideration to any possibility of equipment failure when configuring a system.

2. Only trained personnel should operate pneumatically operated machinery and equipment.

Compressed air can be dangerous if an operator is unfamiliar with it. Assembly, handling or repair of pneumatic systems should be performed by trained and experienced operators.

3. Do not service machinery/equipment or attempt to remove components until safety is confirmed.

1. Inspection and maintenance of machinery/equipment should only be performed once measures to prevent falling or runaway of the driver objects have been confirmed.
2. When equipment is to be removed, confirm the safety process as mentioned above. Cut the supply pressure for this equipment and exhaust all residual compressed air in the system.
3. Before machinery/equipment is restarted, take measures to prevent shooting-out of cylinder piston rod, etc.

4. Contact SMC if the product is to be used in any of the following conditions:

1. Conditions and environments beyond the given specifications, or if product is used outdoors.
2. Installation on equipment in conjunction with atomic energy, railway, air navigation, vehicles, medical equipment, food and beverages, recreation equipment, emergency stop circuits, clutch and brake circuits in press applications, or safety equipment.
3. An application which has the possibility of having negative effects on people, property, or animals, requiring special safety analysis.



Common Precautions

Be sure to read before handling.

For detailed precautions on every series, refer to main text.

Selection

Warning

1. Confirm the specifications.

Products represented in this catalog are designed for use in compressed air applications only (including vacuum), unless otherwise indicated.

Do not use the product outside their design parameters.

Please contact SMC when using the products in applications other than compressed air (including vacuum).

Mounting

Warning

1. Instruction manual

Install the products and operate them only after reading the instruction manual carefully and understanding its contents. Also keep the manual where it can be referred to as necessary.

2. Securing the space for maintenance

When installing the products, please allow access for maintenance.

3. Tightening torque

When installing the products, please follow the listed torque specifications.

Piping

Caution

1. Before piping

Make sure that all debris, cutting oil, dust, etc., are removed from the piping.

2. Wrapping of pipe tape

When screwing piping or fittings into ports, ensure that chips from the pipe threads or sealing material do not get inside the piping. Also, when the pipe tape is used, leave 1.5 to 2 thread ridges exposed at the end of the threads.

Air Supply

Warning

1. Operating fluid

Please consult with SMC when using the product in applications other than compressed air (including vacuum).

Regarding products for general fluid, please ask SMC about applicable fluids.

2. Install an air dryer, aftercooler, etc.

Excessive condensate in a compressed air system may cause valves and other pneumatic equipment to malfunction.

Installation of an air dryer, after cooler etc. is recommended.

3. Drain flushing

If condensate in the drain bowl is not emptied on a regular basis, the bowl will over flow and allow the condensate to enter the compressed air lines.

If the drain bowl is difficult to check and remove, it is recommended that a drain bowl with the auto-drain option be installed.

For compressed air quality, refer to "Air Preparation Equipment" catalog.

4. Use clean air

If the compressed air supply is contaminated with chemicals, synthetic materials, corrosive gas, etc., it may lead to break down or malfunction.

Operating Environment

Warning

1. Do not use in environments where the product is directly exposed to corrosive gases, chemicals, salt water, water or steam.

2. Do not expose the product to direct sunlight for an extended period of time.

3. Do not use in a place subject to heavy vibrations and/or shocks.

4. Do not mount the product in locations where it is exposed to radiant heat.

Maintenance

Warning

1. Maintenance procedures are outlined in the operation manual.

Not following proper procedures could cause the product to malfunction and could lead to damage to the equipment or machine.

2. Maintenance work

If handled improperly, compressed air can be dangerous.

Assembly, handling and repair of pneumatic systems should be performed by qualified personnel only.

3. Drain flushing

Remove drainage from air filters regularly. (Refer to the specifications.)

4. Shut-down before maintenance

Before attempting any kind of maintenance make sure the supply pressure is shut of and all residual air pressure is released from the system to be worked on.

5. Start-up after maintenance and inspection

Apply operating pressure and power to the equipment and check for proper operation and possible air leaks. If operation is abnormal, please verify product set-up parameters.

6. Do not make any modifications to be product.

Do not take the product apart.

Quality Assurance Information (ISO 9001, ISO 14001)

Reliable quality of products in the global market

To enable our customers throughout the world to use our products with even greater confidence, SMC has obtained certification for international standards “ISO 9001” and “ISO 14001”, and created a complete structure for quality assurance and environmental controls. SMC products pursue to meet its customers’ expectations while also considering company’s contribution in society.

Quality management system ISO 9001

This is an international standard for quality control and quality assurance. SMC has obtained a large number of certifications in Japan and overseas, providing assurance to our customers throughout the world.



Environmental management system ISO 14001

This is an international standard related to environmental management systems and environmental inspections. While promoting environmentally friendly automation technology, SMC is also making diligent efforts to preserve the environment.



SMC’s quality control system



Quality policies

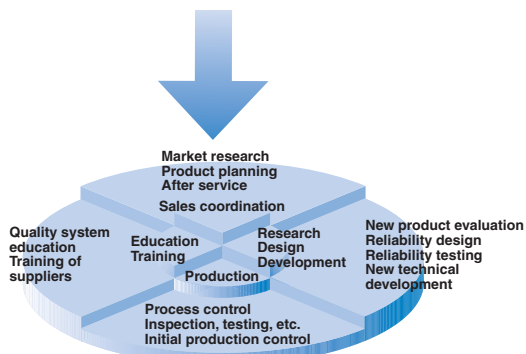

Quality control activities

SMC Product Conforming to Inter

SMC products complying with EN/ISO, CSA/UL standards are supporting



The CE mark indicates that machines and components meet essential requirements of all the EC Directives applied.

It has been obligatory to apply CE marks indicating conformity with EC Directives when machines and components are exported to the member Nations of the EU.

Once "A manufacturer himself" declares a product to be safe by means of CE marking (declaration of conformity by manufacturer), free distribution inside the member Nations of the EU is permissible.

■ CE Mark

SMC provides CE marking to products to which EMC and Low Voltage Directives have been applied, in accordance with CETOP (European hydraulics and pneumatics committee) guide lines.

■ As of February 1998, the following 18 countries will be obliged to conform to CE mark legislation

Iceland, Ireland, United Kingdom, Italy, Austria, Netherlands, Greece, Liechtenstein, Sweden, Spain, Denmark, Germany, Norway, Finland, France, Belgium, Portugal, Luxembourg

■ EC Directives and Pneumatic Components

• Machinery Directive

The Machinery Directive contains essential health and safety requirements for machinery, as applied to industrial machines e.g. machine tools, injection molding machines and automatic machines. Pneumatic equipment is not specified in Machinery Directive. However, the use of SMC products that are certified as conforming to EN Standards, allows customers to simplify preparation work of the Technical Construction File required for a Declaration of Conformity.

• Electromagnetic Compatibility (EMC) Directive

The EMC Directive specifies electromagnetic compatibility. Equipment which may generate electromagnetic interference or whose function may be compromised by electromagnetic interference is required to be immune to electromagnetic affects (EMS/immunity) without emitting excessive electromagnetic affects (EMI/emission).

• Low Voltage Directive

This directive is applied to products, which operate above 50 VAC to 1000 VAC and 75 VDC to 1500 VDC operating voltage, and require electrical safety measures to be introduced.

• Simple Pressure Vessels Directive

This directive is applied to welded vessels whose maximum operating pressure (PS) and volume of vessel (V) exceed 50 bar/L. Such vessels require EC type examination and then CE marking.

national Standards

you to comply with EC directives and CSA/UL standards.



■ CSA Standards & UL Standards

UL and CSA standards have been applied in North America (U.S.A. and Canada) symbolizing safety of electric products, and are defined to mainly prevent danger from electric shock or fire, resulting from trouble with electric products. Both UL and CSA standards are acknowledged in North America as the first class certifying body. They have a long experience and ability for issuing product safety certificate. Products approved by CSA or UL standards are accepted in most states and governments beyond question.

Since CSA is a test certifying body as the National Recognized Testing Laboratory (NRTL) within the jurisdiction of Occupational Safety and Health Administration (OSHA), SMC was tested for compliance with CSA Standards and UL Standards at the same time and was approved for compliance with the two Standards. The above CSA NRTL/C logo is described on a product label in order to indicate that the product is approved by CSA and UL Standards.

■ TSSA (MCCR) Registration Products

TSSA is the regulation in Ontario State, Canada. The products that the operating pressure is more than 5 psi (0.03 MPa) and the piping size is bigger than 1 inch. fall into the scope of TSSA regulation.

Products conforming to CE Standard



With CE symbol for simple visual recognition

In this catalog each accredited product series is indicated with a CE mark symbol. However, in some cases, every available models may not meet CE compliance. Please visit our web site for the latest selection of available models with CE mark.

<http://www.smcworld.com>

SMC's Global Service Network

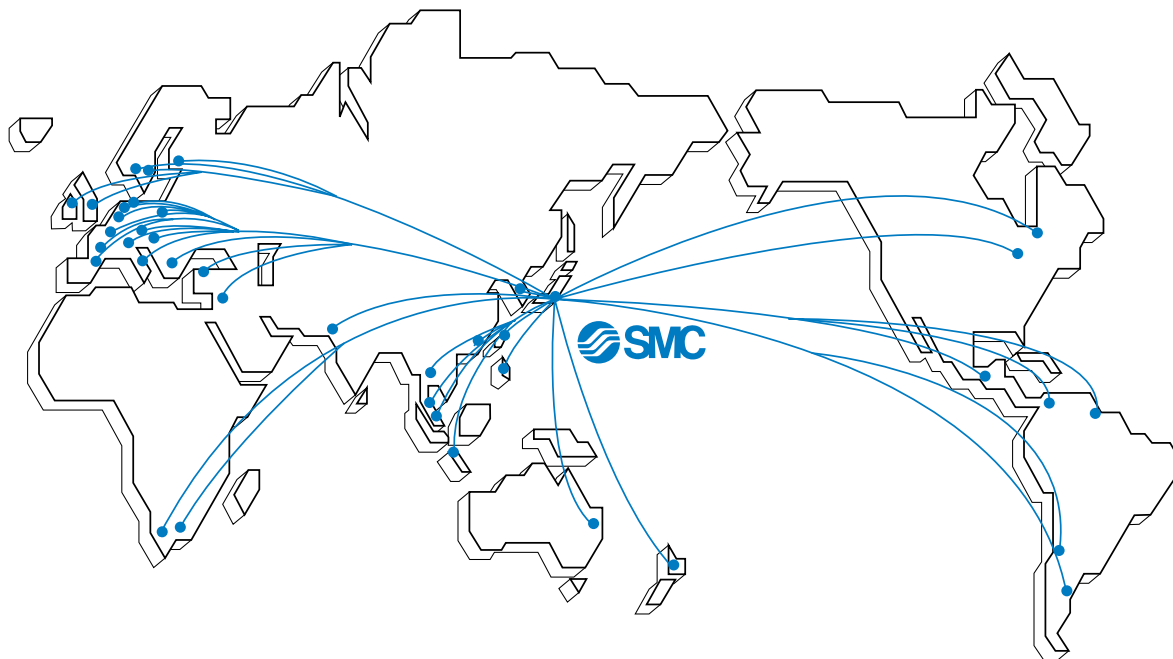

America

U.S.A. **SMC Corporation of America**

3011 North Franklin Road Indianapolis, IN 46226, U.S.A.
TEL: 317-899-4440 FAX: 317-899-3102

CANADA **SMC Pneumatics (Canada) Ltd.**

6768 Financial Drive Mississauga, Ontario, L5N 7J6 Canada
TEL: 905-812-0400 FAX: 905-812-8686

MEXICO **SMC Corporation (Mexico), S.A. DE C.V.**

Carr. Silao-Trejo K.M. 2.5 S/N, Predio San Jose del Duranzo
C.P. 36100, Silao, Gto., Mexico
TEL: 472-72-2-55-00 FAX: 472-72-2-59-44/2-59-46

CHILE **SMC Pneumatics (Chile) S.A.**

Av. La Montaña 1,115 km. 16.5 P. Norte Parque
Industrial Valle Grande, Lampa Santiago, Chile
TEL: 02-270-8600 FAX: 02-270-8601

ARGENTINA **SMC Argentina S.A.**

Teodoro Garcia 3860 (1427) Buenos Aires, Argentina
TEL: 011-4555-5762 FAX: 011-4555-5762

BOLIVIA **SMC Pneumatics Bolivia S.R.L.**

Avenida Beni Numero 4665
Santa Cruz de la Sierra-Casilla de Correo 2281, Bolivia
TEL: 591-3-3428383 FAX: 591-3-3449900

VENEZUELA **SMC Neumatica Venezuela S.A.**

Apartado 40152, Avenida Nueva Granada, Edificio Wanlac,
Local 5, Caracas 1040-A, Venezuela
TEL: 2-632-1310 FAX: 2-632-3871

PERU (Distributor) **IMPECO Automatizacion Industrial S.A.**

AV. Canevaro 752, Lince, Lima, Peru
TEL: 1-471-6002 FAX: 1-471-0935

URUGUAY (Distributor) **BAKO S.A.**

Galicia 1650 esq. Gaboto C.P. 11200, Montevideo, Uruguay
TEL: 2-401-6603 FAX: 2-409-4306

BRAZIL **SMC Pneumaticos Do Brasil Ltda.**

Rua. Dra. Maria Fidelis, nr. 130, Jardim Piraporinha-Diadema-S.P.
CEP: 09950-350, Brasil
TEL: 11-4051-1177 FAX: 11-4071-6636

COLOMBIA (Distributor) **Airmatic Ltda.**

Calle 18 69-05 Apart. Aereo 081045 Santa Fe de Bogotá, Colombia
TEL: 1-424-9240 FAX: 1-424-9260

Europe

U.K. **SMC Pneumatics (U.K.) Ltd.**

Vincent Avenue, Crownhill, Milton Keynes, MK8 0AN, Buckinghamshire, U.K.
TEL: 01908-563888 FAX: 01908-561185

GERMANY **SMC Pneumatik GmbH**

Boschring 13-15 D-63329 Egelsbach, Germany
TEL: 06103-4020 FAX: 06103-402139

ITALY **SMC Italia S.p.A.**

Via Garibaldi 62 I-20061 Carugate Milano, Italy
TEL: 02-9271365 FAX: 02-9271365

FRANCE **SMC Pneumatique S.A.**

1 Boulevard de Strasbourg, Parc Gustave Eiffel, Bussy Saint Georges, F-77600
Marne La Vallee Cedex 3 France
TEL: 01-64-76-10-00 FAX: 01-64-76-10-10

SWEDEN **SMC Pneumatics Sweden AB**

Ekhagsvägen 29-31, S-141 05 Huddinge, Sweden
TEL: 08-603-07-00 FAX: 08-603-07-10

SWITZERLAND **SMC Pneumatik AG**

Dorfstrasse 7, Postfach 117, CH-8484 Weisslingen, Switzerland
TEL: 052-396-3131 FAX: 052-396-3191

AUSTRIA **SMC Pneumatik GmbH (Austria)**

Girakstrasse 8, A-2100 Korneuburg, Austria
TEL: 0-2262-6228-0 FAX: 0-2262-62285

SPAIN **SMC España, S.A.**

Zuazobidea 14 Pol. Ind. Júndiz 01015 Vitoria, Spain
TEL: 945-184-100 FAX: 945-184-510

IRELAND **SMC Pneumatics (Ireland) Ltd.**

2002 Citywest Business Campus, Naas Road, Saggart, Co. Dublin, Ireland
TEL: 01-403-9000 FAX: 01-466-0385

NETHERLANDS (Associated company) **SMC Pneumatics BV**

De Ruyterkade 120, NL-1011 AB Amsterdam, Netherlands
TEL: 020-5318888 FAX: 020-5318880

GREECE (Distributor) **S.Parianopoulos S.A.**

7, Konstantinoupoleos Street 11855 Athens, Greece
TEL: 01-3426076 FAX: 01-3455578

DENMARK **SMC Pneumatik A/S**

Knudsminde 4 B DK-8300
Odder, Denmark
TEL: 70252900 FAX: 70252901

Europe

FINLAND SMC Pneumatics Finland OY

PL72, Tiistiniityntie 4, SF-02231 ESP00, Finland
TEL: 09-8595-80 FAX: 09-8595-8595

NORWAY SMC Pneumatics Norway A/S

Vollsvæien 13C, Granfoss Næringspark N-1366 LYSAKER, Norway
TEL: 67-12-90-20 FAX: 67-12-90-21

BELGIUM (Distributor) SMC Pneumatics N.V./S.A.

Nijverheidsstraat 20 B-2160 Wommelgem Belgium
TEL: 03-355-1464 FAX: 03-355-1466

POLAND SMC Industrial Automation Polska Sp.z.o.o.

ul. Konstruktorska 11A, PL-02-673 Warszawa, Poland
TEL: 022-548-5085 FAX: 022-548-5087

TURKEY (Distributor) Entek Pnömatik San.ve Tic. Ltd. Sti

Perpa Tic. Merkezi Kat:11 No.1625 80270 Okmeydani Istanbul, Türkiye
TEL: 0212-221-1512 FAX: 0212-221-1519

RUSSIA SMC Pneumatik LLC.

36/40 Sredny prospect V.O. St. Petersburg 199004, Russia
TEL: 812-118-5445 FAX: 812-118-5449

CZECH SMC Industrial Automation CZ s.r.o.

Hudcova 78a, CZ-61200 Brno, Czech Republic
TEL: 05-4121-8034 FAX: 05-4121-8034

HUNGARY SMC Hungary Ipari Automatizálási kft.

Budafoki ut 107-113 1117 Budapest
TEL: 01-371-1343 FAX: 01-371-1344

ROMANIA SMC Romania S.r.l.

Str. Frunzei, Nr. 29, Sector 2, Bucharest, Romania
TEL: 01-3205111 FAX: 01-3261489

SLOVAKIA SMC Priemyselná automatizácia, s.r.o.

Nova 3, SK-83103 Bratislava
TEL: 02-4445-6725 FAX: 02-4445-6028

SLOVENIA SMC Industrijska Avtomatila d.o.o.

Grajski trg 15, SLO- 8360 Zuzemberk, Slovenia
TEL: 07388-5240 FAX: 07388-5249

LATVIA SMC Pneumatics Latvia SIA

Šmerļa ielā 1-705, Rīga LV-1006
TEL: 777 94 74 FAX: 777 94 75

SOUTH AFRICA (Distributor) Hyflo Southern Africa (Pty.) Ltd.

P.O.Box 240 Paardeneiland 7420 South Africa
TEL: 021-511-7021 FAX: 021-511-4456

EGYPT (Distributor) Saadani Trading & Ind. Services

15 Sebaai Street, Miami 21411 Alexandria, Egypt
TEL: 3-548-50-34 FAX: 3-548-50-34

Oceania/Asia

AUSTRALIA SMC Pneumatics (Australia) Pty.Ltd.

14-18 Hudson Avenue Castle Hill NSW 2154, Australia
TEL: 02-9354-8222 FAX: 02-9894-5719

NEW ZEALAND SMC Pneumatics (New Zealand) Ltd.

8C Sylvia Park Road Mt.Wellington Auckland, New Zealand
TEL: 09-573-7007 FAX: 09-573-7002

TAIWAN SMC Pneumatics (Taiwan) Co.,Ltd.

17, Lane 205, Nansan Rd., Sec.2, Luzhu-Hsiang, Taoyuan-Hsien, TAIWAN
TEL: 03-322-3443 FAX: 03-322-3387

HONG KONG SMC Pneumatics (Hong Kong) Ltd.

29/F, Clifford Centre, 778-784 Cheung, Sha Wan Road, Lai Chi Kok, Kowloon, Hong Kong
TEL: 2744-0121 FAX: 2785-1314

SINGAPORE SMC Pneumatics (S.E.A.) Pte. Ltd.

89 Tuas Avenue 1, Jurong Singapore 639520
TEL: 6861-0888 FAX: 6861-1889

PHILIPPINES SHOKETSU SMC Corporation

Unit 201 Common Goal Tower, Madrigal Business Park, Ayala Alabang Muntinlupa, Philippines
TEL: 02-8090565 FAX: 02-8090586

MALAYSIA SMC Pneumatics (S.E.A.) Sdn. Bhd.

Lot 36 Jalan Delima1/1, Subang Hi-Tech Industrial Park, Batu 3 40000 Shah Alam Selangor, Malaysia
TEL: 03-56350590 FAX: 03-56350602

SOUTH KOREA SMC Pneumatics Korea Co., Ltd.

Woolim e-BIZ Center (Room 1008), 170-5, Guro-Dong, Guro-Gu, Seoul, 152-050, South Korea
TEL: 02-3219-0700 FAX: 02-3219-0702

CHINA SMC (China) Co., Ltd.

7 Wan Yuan St. Beijing Economic & Technological Development Zone 100176, China
TEL: 010-67882111 FAX: 010-67881837

THAILAND SMC Thailand Ltd.

134/6 Moo 5, Tiwanon Road, Bangkok, Amphur Muang, Patumthani 12000, Thailand
TEL: 02-963-7099 FAX: 02-501-2937

INDIA SMC Pneumatics (India) Pvt. Ltd.

D-107 to 112, Phase-2, Extension, Noida, Dist. Gautaim Budh Nagar, U.P. 201 305, India
TEL: (0120)-4568730 FAX: 0120-4568933

INDONESIA (Distributor) P.T. Riyadi Putera Makmur

Jalan Hayam Wuruk Komplek Glodok Jaya No. 27-28 Jakarta 11180 Indonesia
TEL: 021-625 5548 FAX: 021-625 5888

PAKISTAN (Distributor) Jubilee Corporation

First Floor Mercantile Centre, Newton Road Near Boulton Market P.O. Box 6165 Karachi 74000 Pakistan
TEL: 021-243-9070/8449 FAX: 021-241-4589

ISRAEL (Distributor) Baccara Automation Control

Kvutza Geva 18915 Israel
TEL: 04-653-5960 FAX: 04-653-1445

SAUDI ARABIA (Distributor) Assaggaff Trading Est.

P.O. Box 3385 Al-Amir Majed Street, Jeddah-21471, Saudi Arabia
TEL: 02-6761574 FAX: 02-6708173