

### SCR/Diode POW-R-BLOK™ Modules 130 Amperes/800 Volts

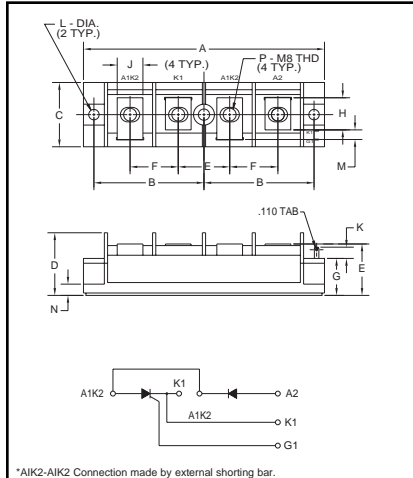

#### Outline Drawing

Dimension	Inches	Millimeters
A	5.906	150.0
B	2.697±0.02	68.5±0.2
C	1.575	40.0
D	1.535	39.0
E	1.260	32.0
F	1.181	30.0
G	0.906	23.0
H	0.787	20.0
J	0.630	16.0
K	0.276	7.0
L	0.256±0.008 Dia. Dia. 6.5±0.2	
M	0.236	6.0
N	0.197	5.0
P	M8 Metric	M8



**CM520813  
SCR/Diode  
POW-R-BLOK™ Modules  
130 Amperes/800 Volts**

#### Description:

Powerex SCR/Diode POW-R-BLOK™ Modules are designed for use in applications requiring Half-Control and isolated packaging. The modules are isolated for easy mounting with other components on common heatsinks.

#### Features:

- Isolated Mounting
- Glass Passivated Chips
- Metal Baseplate
- Low Thermal Impedance

#### Applications:

- Battery Supplies
- Bridge Circuits
- AC and DC Motor Control
- Tap Changers
- Lighting Control

#### Ordering Information:

Select the complete eight digit module part number you desire from the table below. Example: CM420813 is a 800 Volt, 130 Ampere SCR/Diode POW-R-BLOK™ Module.

Type	Voltage Volts (x100)	Current Rating Amperes (x10)
CM52	08	13

**CM520813**  
**SCR/Diode POW-R-BLOK™ Modules**  
 130 Amperes/800 Volts

**Absolute Maximum Ratings**

Characteristics	Symbol	CM520813	Units
Peak Forward Blocking Voltage	$V_{DRM}$	800	Volts
Transient Peak Forward Blocking Voltage (Non-Repetitive), $t < 5ms$	$V_{DSM}$	960	Volts
DC Forward Blocking Voltage	$V_{D(DC)}$	640	Volts
Peak Reverse Blocking Voltage	$V_{RRM}$	800	Volts
Transient Peak Reverse Blocking Voltage (Non-Repetitive), $t < 5ms$	$V_{RSM}$	960	Volts
DC Reverse Blocking Voltage	$V_{R(DC)}$	640	Volts
RMS On-State Current	$I_{T(RMS)}, I_{F(RMS)}$	205	Amperes
Average On-State Current, $T_C = 85^\circ C$	$I_{T(AV)}, I_{F(AV)}$	130	Amperes
Peak One-Cycle Surge (Non-Repetitive) On-State Current (60Hz)	$I_{TSM}, I_{FSM}$	2600	Amperes
Peak One-Cycle Surge (Non-Repetitive) On-State Current (50Hz)	$I_{TSM}, I_{FSM}$	2365	Amperes
$I^2t$ (for Fusing), 8.3 milliseconds	$I^2t$	28000	A <sup>2</sup> sec
Critical Rate-of-Rise of On-State Current*	$di/dt$	100	Amperes/ $\mu s$
Peak Gate Power Dissipation	$P_{GM}$	10.0	Watts
Average Gate Power Dissipation	$P_{G(AV)}$	3.0	Watts
Peak Forward Gate Voltage	$V_{GFM}$	10	Volts
Peak Reverse Gate Voltage	$V_{GRM}$	5.0	Volts
Peak Forward Gate Current	$I_{GFM}$	4.0	Amperes
Storage Temperature	$T_{STG}$	-40 to 125	$^\circ C$
Operating Temperature	$T_j$	-40 to 125	$^\circ C$
Maximum Mounting Torque M6 Mounting Screw	—	26	in.-lb.
Maximum Mounting Torque M5 Terminal Screw	—	72	in.-lb.
Module Weight (Typical)	—	300	Grams
V Isolation	$V_{RMS}$	2000	Volts

\* $T_j = 125^\circ C, I_G = 0.5A, V_D = 1/2 V_{DRM}$

**Electrical and Thermal Characteristics,  $T_j = 25^\circ C$  unless otherwise specified**

Characteristics	Symbol	Test Conditions	CM520813	Units
<b>Blocking State Maximums</b>				
Forward Leakage Current, Peak	$I_{DRM}$	$T_j = 125^\circ C, V_{DRM} = \text{Rated}$	30	mA
Reverse Leakage Current, Peak	$I_{RRM}$	$T_j = 125^\circ C, V_{RRM} = \text{Rated}$	30	mA
<b>Conducting State Maximums</b>				
Peak On-State Voltage	$V_{FM}, V_{TM}$	$I_{FM} = 390A, I_{TM} = 390A$	1.3	Volts
<b>Switching Minimums</b>				
Critical Rate-of-Rise of Off-State Voltage	$dv/dt$	$T_j = 125^\circ C, V_D = 2/3 V_{DRM}$	500	Volts/ $\mu s$
<b>Thermal Maximums</b>				
Thermal Resistance, Junction-to-Case	$R_{\theta(J-C)}$	Per Module	0.22	$^\circ C/Watt$
Thermal Resistance, Case-to-Sink (Lubricated)	$R_{\theta(C-S)}$	Per Module	0.05	$^\circ C/Watt$
<b>Gate Parameters Maximums</b>				
Gate Current-to-Trigger	$I_{GT}$	$V_D = 6V, R_L = 2\Omega$	100	mA
Gate Voltage-to-Trigger	$V_{GT}$	$V_D = 6V, R_L = 2\Omega$	3.0	Volts

**CM520813**  
**SCR/Diode POW-R-BLOK™ Modules**  
 130 Amperes/800 Volts

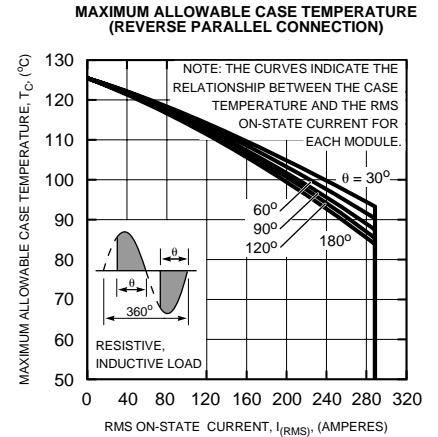
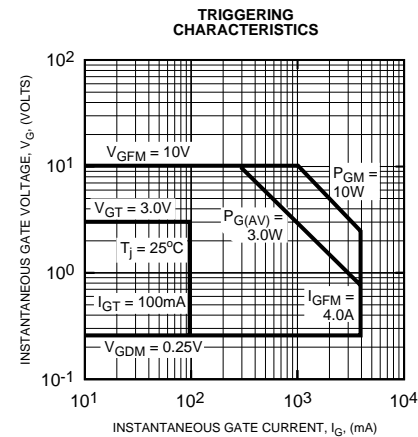
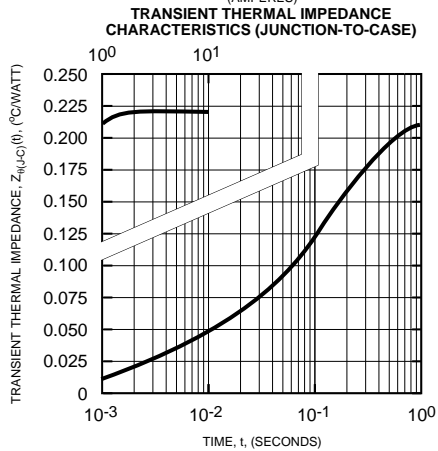
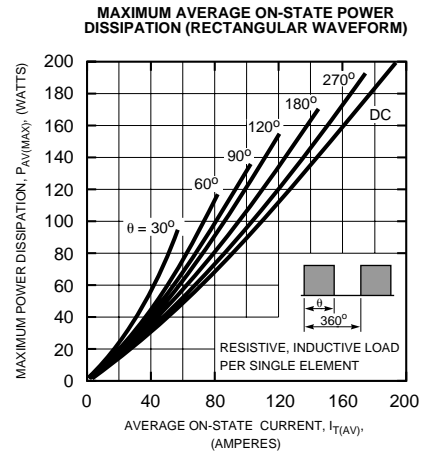
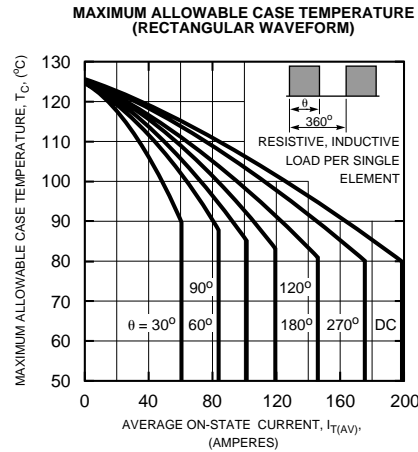
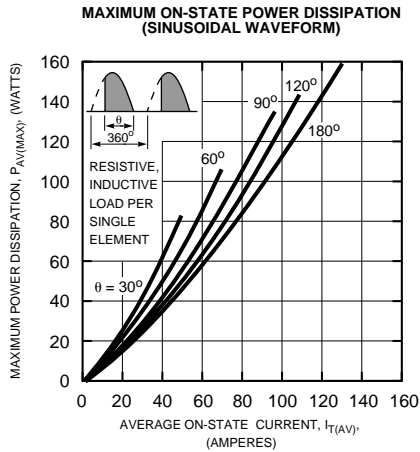
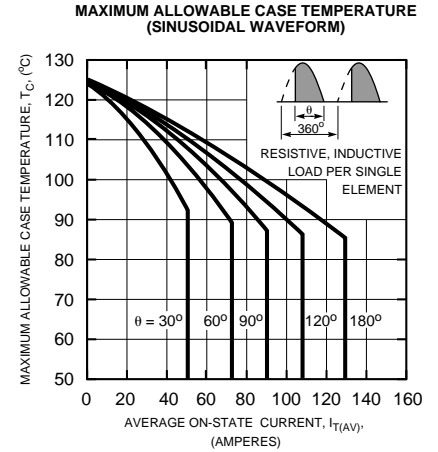
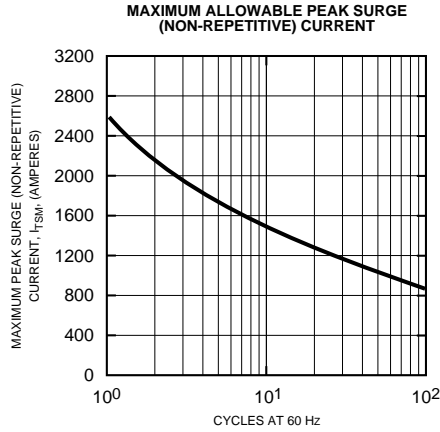
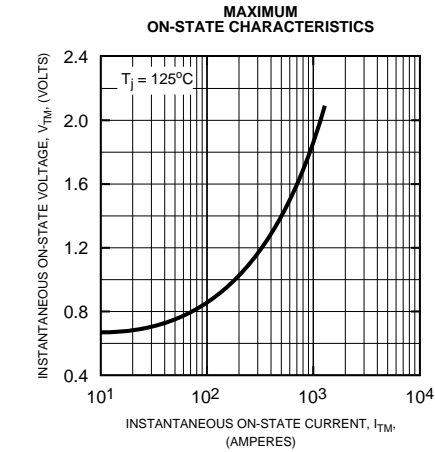

**CM520813**  
**SCR/Diode POW-R-BLOK™ Modules**  
 130 Amperes/800 Volts

**MAXIMUM ON-STATE POWER DISSIPATION (REVERSE PARALLEL CONNECTION)**

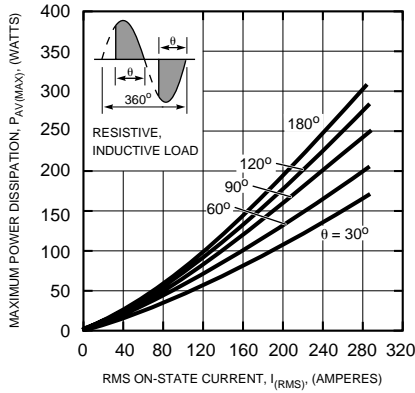

NOTE: THE CURVES INDICATE THE RELATIONSHIP BETWEEN THE AVERAGE ON-STATE POWER DISSIPATION PER MODULE AND THE RMS ON-STATE CURRENT.

**MAXIMUM ALLOWABLE CASE TEMPERATURE (SINGLE PHASE BRIDGE CONNECTION)**

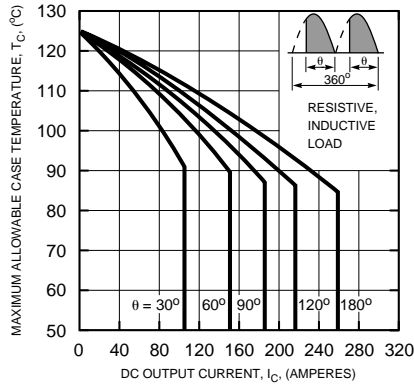

NOTE: THE CURVES INDICATE THE RELATIONSHIP BETWEEN THE CASE TEMPERATURE AND THE DC OUTPUT CURRENT (FOR TWO ELEMENTS) WHEN USED IN THE SINGLE PHASE BRIDGE CONFIGURATION.

**MAXIMUM ON-STATE POWER DISSIPATION (SINGLE PHASE BRIDGE CONNECTION)**

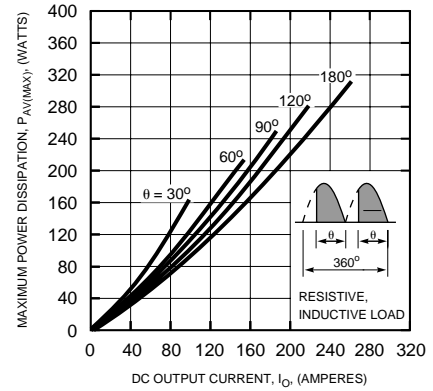

NOTE: THE CURVES INDICATE THE RELATIONSHIP BETWEEN THE AVERAGE ON-STATE POWER DISSIPATION AND THE DC OUTPUT CURRENT FOR THE SINGLE PHASE BRIDGE CONFIGURATION (POWER DISSIPATION EXPRESSED FOR EACH MODULE AND DC OUTPUT CURRENT EXPRESSED FOR THE PAIR)

**MAXIMUM ALLOWABLE CASE TEMPERATURE (THREE PHASE BRIDGE CONNECTION)**

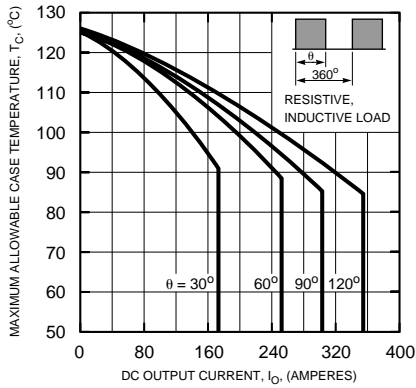

NOTE: THE CURVES INDICATE THE RELATIONSHIP BETWEEN THE CASE TEMPERATURE AND THE DC OUTPUT CURRENT (FOR THREE MODULES) IN THE THREE PHASE CONFIGURATION.

**MAXIMUM ON-STATE POWER DISSIPATION (THREE PHASE BRIDGE CONNECTION)**

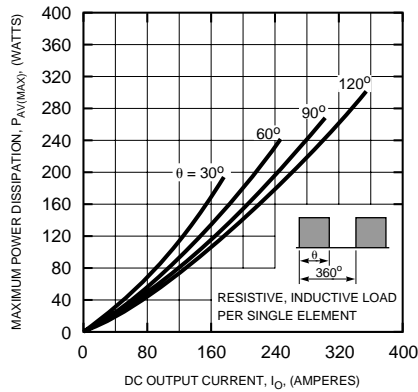

NOTE: THE CURVES INDICATE THE RELATIONSHIP BETWEEN THE ON-STATE POWER DISSIPATION (PER MODULE) AND THE DC OUTPUT CURRENT (FOR THREE MODULES) IN THE THREE PHASE BRIDGE CONFIGURATION.