



22.5 mm DIN rail mounting TU2R1 Part number 88865305



- Multi-function or mono-function
- Multi-range
- Multi-voltage
- Screw or spring terminals
- LED status indicator
- Option of connecting an external power supply to the control input
- 3-wire sensor control option

Part numbers

	Type	Functions	Timing	Output	Nominal rating	Connections	Supply voltage
88 865 305	TU2R1	A - At - B - C - H - Ht - Di - D - Ac - Bw	-	2 timed changeover relays	8 A	Screw terminals	24 V DC / 24 →240 V AC

Specifications

Timing

Timing ranges (7 ranges)	1 s - 10 s - 1 min - 10 min - 1 h - 10 h - 100 h TK2R1 : 0.6s - 2.5s - 20s - 160 s
Repetition accuracy with constant parameters	± 0.5 % (IEC/EN 1812-1)
Drift Temperature	± 0,05 % / °C
Drift Voltage	± 0.2 % / V
Display accuracy according to IEC/EN 61812-1	± 10 % / 25 °C
Minimum pulse duration typically (relay version)	30 ms
Minimum pulse duration typically (solid state version)	50 ms
Minimum pulse duration typically (relay version under load)	100 ms
Maximum reset time by de-energisation typically (relay version)	100 ms
Maximum reset time by de-energisation typically (solid state version)	350 ms
Immunity from micro power cuts : typical	> 10 ms
Supply	*** TRADUCTION MANQUANTE ***
Multi-voltage power supply	Depending on version
Frequency (Hz)	50 / 60
Operating range	85 to 110 % Un (85 to 120 % Un for 12V AC/DC)
Operator factor	100 %
Max. absorbed power	0,6 W 24 V AC/DC 1,5 W 230 V AC 32 VA 230 V AC

Output specification

1 or 2 changeover relays, AgNi (cadmium-free)	2000 VA/80 W
Rated power	2000 VA/80 W
Maximum breaking current	8 A AC 8A DC
Minimum breaking current	10 mA / 5 V DC
Voltage breaking capacity	250 V AC/ DC
Electrical life (operations)	10 ⁵ operations 8 A 250 V resistive
Mechanical life (operations)	5x10 ⁶
Breakdown voltage acc. to IEC/EN 61812-1	2.5 kV / 1 min / 1 mA / 50 Hz
Impulse voltage acc. to IEC/EN 60664-1, IEC/EN 61812-1	5 kV, wave 1.2 / 50 µs

Solid state output

Rated power	0,7 A AC/DC 20 °C (0,5 A UL)
Derating	5 mA / °C
Maximum admissible current	20 A ≤ 10 ms
Minimum breaking current	10 mA
Leakage current	< 5 mA
Voltage breaking capacity	250 V AC/ DC
Maximum voltage drop at terminals	3 wire 4V - 2 wire 8V
Electrical life (operations)	10 ⁸
Mechanical life (operations)	10 ⁸
Breakdown voltage acc. to IEC/EN 60664-1, IEC/EN 60255-5	2.5 kV to 1 mA / 1 min
Input type	Volt-free contact 3-wire PNP output control option residual voltage : 0.4V whatever the timer power supply

General characteristics

Conformity to standards	IEC/EN 61812-1 IEC/EN 61000-6-1 IEC/EN 61000-6-2 IEC/EN 61000-6-3 IEC/EN 61000-6-4
Certifications	CE, UL, cUL, CSA, GL
Temperature limits use (°C)	-20 →+60
Temperature limits stored (°C)	-30 →+60
Installation category (acc. to IEC/EN 60664-1)	Voltage surge category
Creepage distance and clearance acc. to IEC/EN 60664-1	4 kV / 3
Protection (IEC/EN 60529)	IP 20 IP 40
Degree of protection acc. to IEC/EN 60529 Front face (except Tk2R1)	IP 50
Vibration resistance acc. to IEC/EN 60068-2-6	f = 10 ■ 55 Hz A = 0,35 mm
Relative humidity no condensation acc. to IEC/EN 60068-2-30	93 % sans condensation
Electromagnetic compatibility - Immunity to electrostatic discharges acc to IEC/EN 61000-4-2	Level III (Air 8 KV / Contact 6 KV)
Immunity to radiated, radio-frequency, electromagnetic field acc. IEC/EN 61000-4-3	Level III 10V/m (80 M Hz to 1 G Hz)
Immunity to rapid transient bursts acc. to IEC/EN 61000-4-4	Level III (direct 2kV / Capacitive coupling clamp 1 KV)
Immunity to shock waves on power supply acc. to IEC/EN 61000-4-5	Level III (2 KV / common mode 2 KV/residual current mode 1KV)
Immunity to radio frequency in common mode acc. to IEC/EN 61000-4-6	Level III (10V rms : 0.15 M Hz to 80 M Hz)
Immunity to voltage dips and breaks acc. to IEC/EN 61000-4-11	30 %/10 ms 60 %/100 ms > 95 %/5 s
Mains-borne and radiated emissions acc. to EN 55022 (CISPR22), EN55011 (CISPR11)	Class B
Fixing : Symmetrical DIN rail	35 mm
Connection capacity - without ferrule	2 x 2,5 mm ²
Connection capacity - with ferrule	2 x 1,5 mm ²
Spring terminals, 2 terminals per connection point - flexible wire	1,5 mm ²
Spring terminals, 2 terminals per connection point - rigid wire	2,5 mm ²
Housing material	Self-extinguishing
Weight : casing 17,5 mm	60 g
Weight : casing 22,5 mm	90 g
Weight : plug-in casing	80 g

90

Display

State displayed by 2 LEDs

- Flashing green when on
- Relay LED yellow during timing

Green LED operation indicator

Pulsing :

- Timer on, no timing in process

Permanently lit :

- Relay waiting, no timing in process

Dimensions (mm)

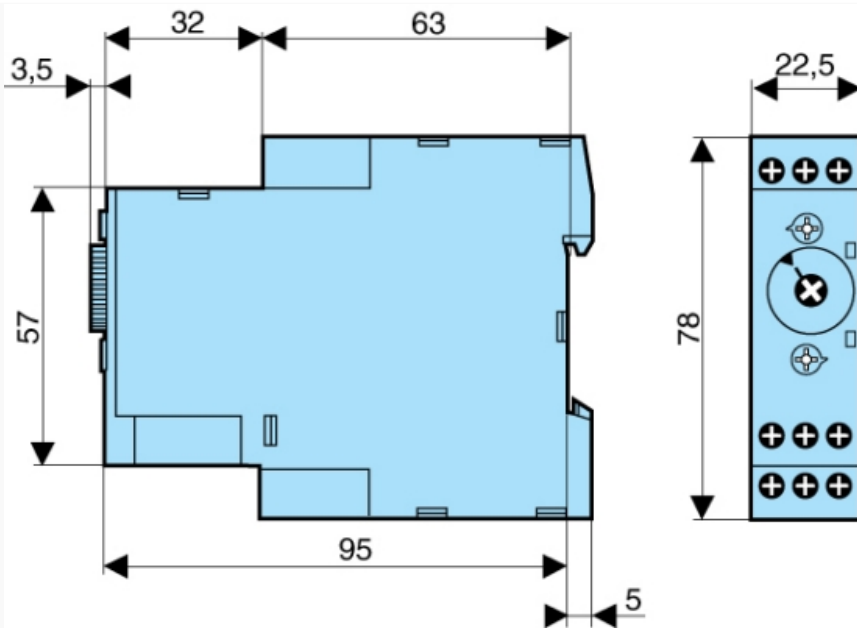

Curves

Function A - 2 relay outputs

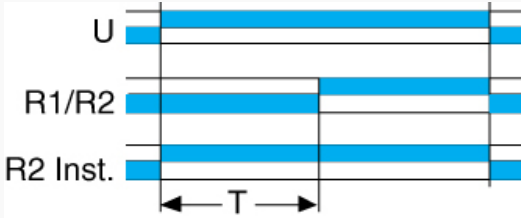

Function A

Delay on energisation with 2 timed outputs or 1 timed and 1 instantaneous

Curves

Function Ac - 2 relay outputs

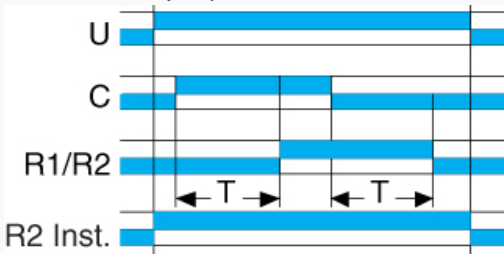

Function Ac

Timing after closing and opening of control contact with 2 timed outputs or 1 timed and 1 instantaneous

Curves

Function At - 2 relay outputs

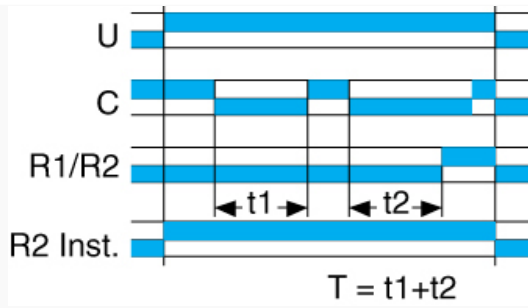

Function At
 Timing on energisation with memory with 2 timed outputs or 1 timed and 1 instantaneous

Curves

Function B - 2 relay outputs

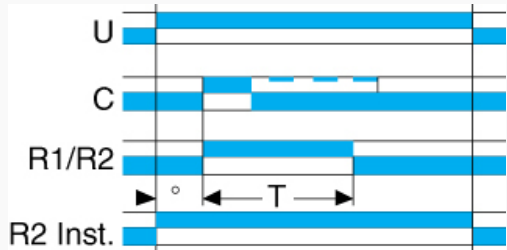

Function B
 Timing on impulse one shot with 2 timed outputs or 1 timed and 1 instantaneous

Curves

Function Bw - 2 relay outputs

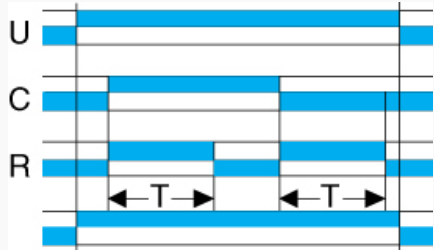

Function Bw
 Pulse output (adjustable) with 2 timed outputs or 1 timed and 1 instantaneous

Curves

Function C - 2 relay outputs

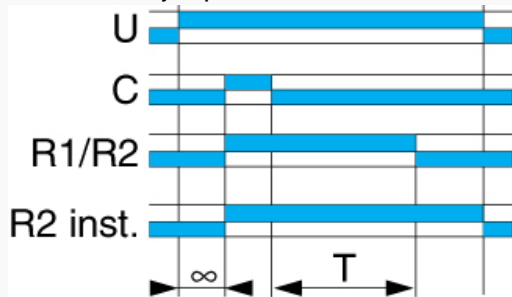

Function C
 Timing after impulse with 2 timed outputs or 1 timed and 1 instantaneous

Curves

Function D - 2 relay outputs

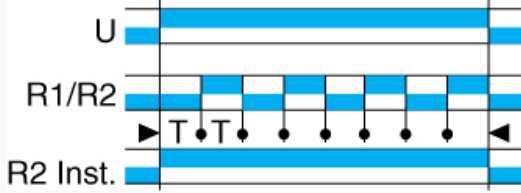

Function D

Flip-flop
Pulse start with 2 timed outputs or 1 timed and 1 instantaneous

Curves

Function Di - 2 relay outputs

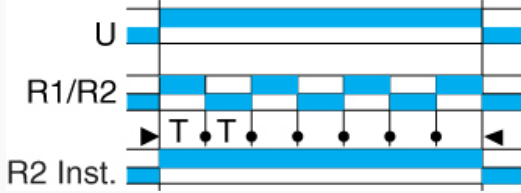

Function Di

Flip-flop
Pulse start with 2 timed outputs or 1 timed and 1 instantaneous

Curves

Function H - 2 relay outputs

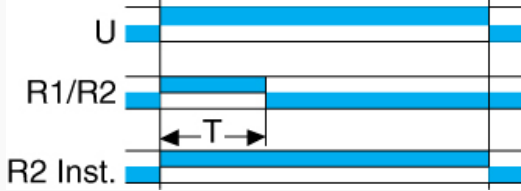

Function H

Timing on energisation with 2 timed outputs or 1 timed and 1 instantaneous

Curves

Function Ht - 2 relay outputs

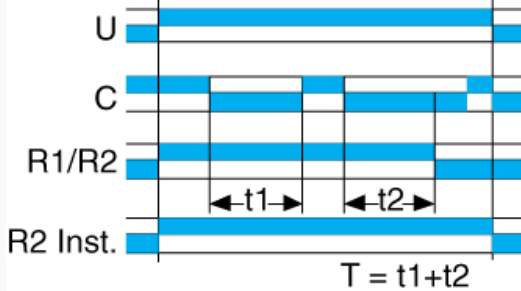

Function Ht

Delay on energisation with memory with 2 timed outputs or 1 timed and 1 instantaneous

Connections

2 changeover relay outputs

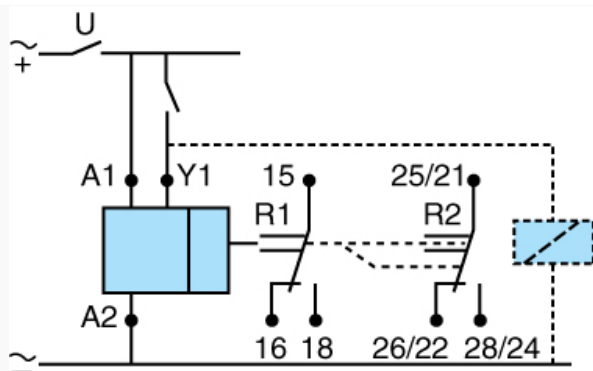

Functions

A - At - B - C - H - Ht - Di - D - Ac - Bw
 Ad - Ah - N - O - P - Pt - TL - Tt - W