



Plug-in OUR3 Part number 88867103



- Multi-function or mono-function
- Multi-range
- Multi-voltage
- Relay output 1 or 2 : 8 A - 250 V (10 A UL)
- LED status indicator
- Option of connecting an external power supply to the control input
- 3-wire sensor control option

Part numbers

Type	Functions	Timing	Output	Nominal rating	Connections	Supply voltage
88 867 103 OUR3	A - At - B - C - H - Ht - Di - D - Ac - Bw	0,1s→100h	1 changeover relay	8 A	8-pin	12 →240 V AC / DC

Specifications

Timing

Timing ranges (7 ranges)	1 s - 10 s - 1 min - 10 min - 1 h - 10 h - 100 h TK2R1 : 0.6s - 2.5s - 20s - 160 s
Repetition accuracy with constant parameters	± 0.5 % (IEC/EN 1812-1)
Drift Temperature	± 0,05 % / °C
Drift Voltage	± 0.2 % / V
Display accuracy according to IEC/EN 61812-1	± 10 % / 25 °C
Minimum pulse duration typically (relay version)	30 ms
Minimum pulse duration typically (solid state version)	50 ms
Minimum pulse duration typically (relay version under load)	100 ms
Maximum reset time by de-energisation typically (relay version)	100 ms
Maximum reset time by de-energisation typically (solid state version)	350 ms
Immunity from micro power cuts : typical	> 10 ms
Supply	*** TRADUCTION MANQUANTE ***
Multi-voltage power supply	Depending on version
Frequency (Hz)	50 / 60
Operating range	85 to 110 % Un (85 to 120 % Un for 12V AC/DC)
Operator factor	100 %
Max. absorbed power	0,6 W 24 V AC/DC 1,5 W 230 V AC 32 VA 230 V AC

Output specification

1 or 2 changeover relays, AgNi (cadmium-free)	2000 VA/80 W
Rated power	2000 VA/80 W
Maximum breaking current	8 A AC 8A DC
Minimum breaking current	10 mA / 5 V DC
Voltage breaking capacity	250 V AC/ DC
Electrical life (operations)	10 ⁵ operations 8 A 250 V resistive
Mechanical life (operations)	5x10 ⁶
Breakdown voltage acc. to IEC/EN 61812-1	2.5 kV / 1 min / 1 mA / 50 Hz
Impulse voltage acc. to IEC/EN 60664-1, IEC/EN 61812-1	5 kV, wave 1.2 / 50 µs

Solid state output

Rated power	0,7 A AC/DC 20 °C (0,5 A UL)
Derating	5 mA / °C
Maximum admissible current	20 A ≤ 10 ms
Minimum breaking current	10 mA
Leakage current	< 5 mA
Voltage breaking capacity	250 V AC/ DC
Maximum voltage drop at terminals	3 wire 4V - 2 wire 8V
Electrical life (operations)	10 ⁸
Mechanical life (operations)	10 ⁸
Breakdown voltage acc. to IEC/EN 60664-1, IEC/EN 60255-5	2.5 kV to 1 mA / 1 min
Input type	Volt-free contact 3-wire PNP output control option residual voltage : 0.4V whatever the timer power supply

General characteristics

Conformity to standards	IEC/EN 61812-1 IEC/EN 61000-6-1 IEC/EN 61000-6-2 IEC/EN 61000-6-3 IEC/EN 61000-6-4
Certifications	CE, UL, cUL, CSA, GL
Temperature limits use (°C)	-20 → +60
Temperature limits stored (°C)	-30 → +60
Installation category (acc. to IEC/EN 60664-1)	Voltage surge category
Creepage distance and clearance acc. to IEC/EN 60664-1	4 kV / 3
Protection (IEC/EN 60529)	IP 20 IP 40
Degree of protection acc. to IEC/EN 60529 Front face (except Tk2R1)	IP 50
Vibration resistance acc. to IEC/EN 60068-2-6	f = 10 ■ 55 Hz A = 0,35 mm
Relative humidity no condensation acc. to IEC/EN 60068-2-30	93 % sans condensation
Electromagnetic compatibility - Immunity to electrostatic discharges acc to IEC/EN 61000-4-2	Level III (Air 8 KV / Contact 6 KV)
Immunity to radiated, radio-frequency, electromagnetic field acc. IEC/EN 61000-4-3	Level III 10V/m (80 M Hz to 1 G Hz)
Immunity to rapid transient bursts acc. to IEC/EN 61000-4-4	Level III (direct 2kV / Capacitive coupling clamp 1 KV)
Immunity to shock waves on power supply acc. to IEC/EN 61000-4-5	Level III (2 KV / common mode 2 KV/residual current mode 1KV)
Immunity to radio frequency in common mode acc. to IEC/EN 61000-4-6	Level III (10V rms : 0.15 M Hz to 80 M Hz)
Immunity to voltage dips and breaks acc. to IEC/EN 61000-4-11	30 %/10 ms 60 %/100 ms > 95 %/5 s
Mains-borne and radiated emissions acc. to EN 55022 (CISPR22), EN55011 (CISPR11)	Class B
Fixing : Symmetrical DIN rail	35 mm
Connection capacity - without ferrule	2 x 2,5 mm ²
Connection capacity - with ferrule	2 x 1,5 mm ²
Spring terminals, 2 terminals per connection point - flexible wire	1,5 mm ²
Spring terminals, 2 terminals per connection point - rigid wire	2,5 mm ²
Housing material	Self-extinguishing
Weight : casing 17,5 mm	60 g
Weight : casing 22,5 mm	90 g
Weight : plug-in casing	80 g

80

Accessories

Accessories	Code
8-pin connector base	25 622 128

Display

State displayed by 1 LED

- Flashing green when on
- Green LED operation indicator

Pulsing :

- timer on, no timing in progress (except functions Di-D and Li-L)

Flashing :

- timing in progress

Permanently lit :

- Relay waiting, no timing in progress

Dimensions (mm)

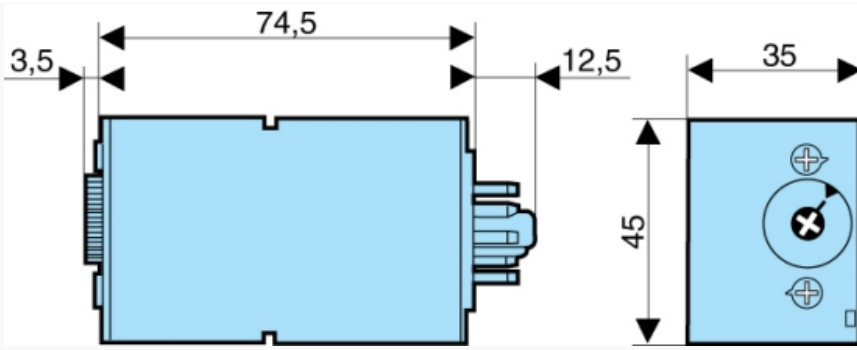

Dimensions (mm)

Accessories

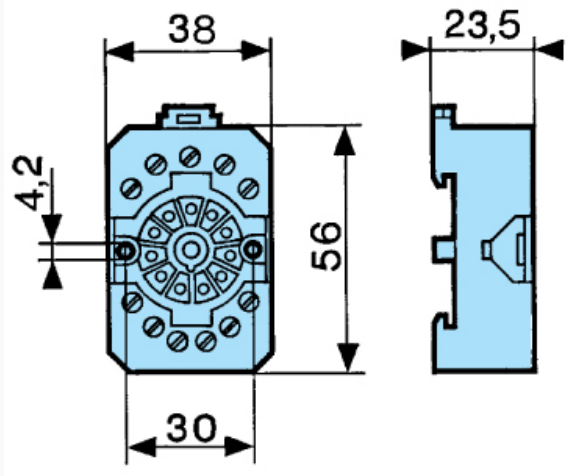

Curves

Function A

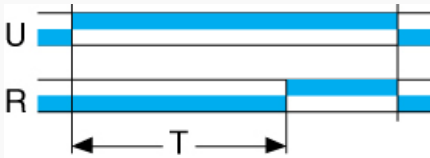

Function A

Delay on energisation 1 relay

Curves

Function Ac



Function Ac

Timing after closing and opening of control contact 1 relay

Curves

Function At

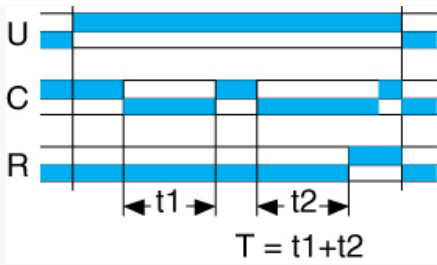

Function At
Timing on energisation with memory 1 relay

Curves

Function B

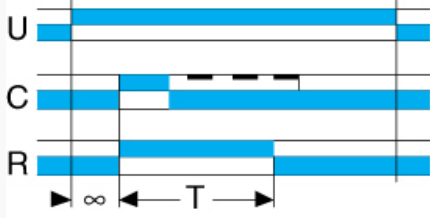

Function B
Timing on impulse one shot

Curves

Function Bw

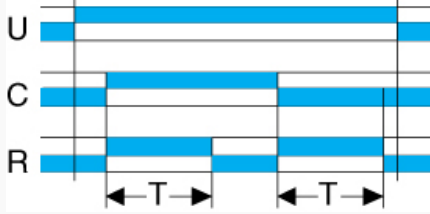

Function Bw
Pulse output (adjustable) 1 relay

Curves

Function C

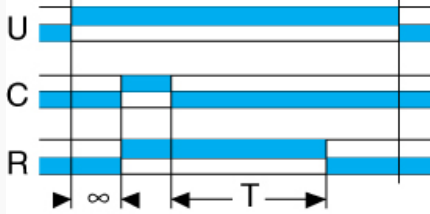

Function C
Timing after impulse 1 timer

Curves

Function D

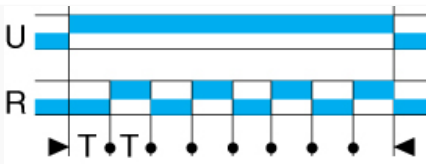

Function D

Flip-flop 1 relay Pause start

Curves

Function Di

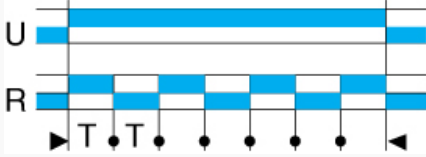

Function Di

Flip-flop 1 relay Pulse start

Curves

Function H

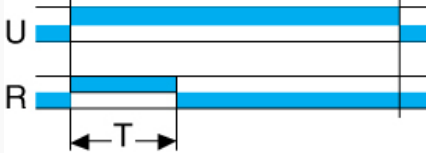

Function H

Timing on energisation 1 relay

Curves

Function Ht

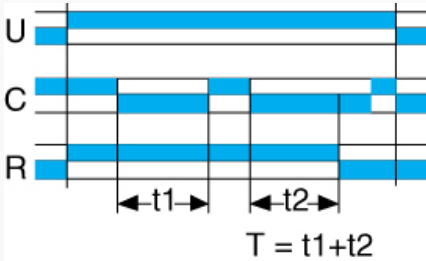

Function Ht

Delay on energisation with memory 1 relay

Connections

8-pin 1 relay output

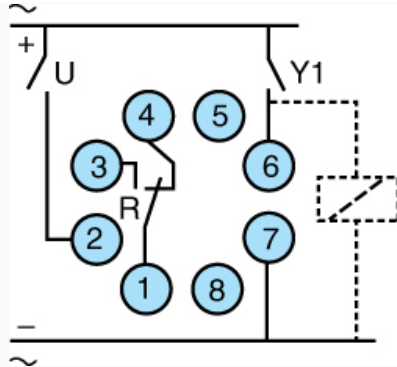
**Functions**

Functions A - At / H - Ht / B / C / Di - D / Ac / Bw