

THIS DOCUMENT AND THE DATA DISCLOSED
HEREIN OR HERewith IS NOT TO BE REPRODUCED,
USED, OR DISCLOSED IN WHOLE OR IN PART
TO ANYONE WITHOUT PERMISSION OF VICOR CORP.

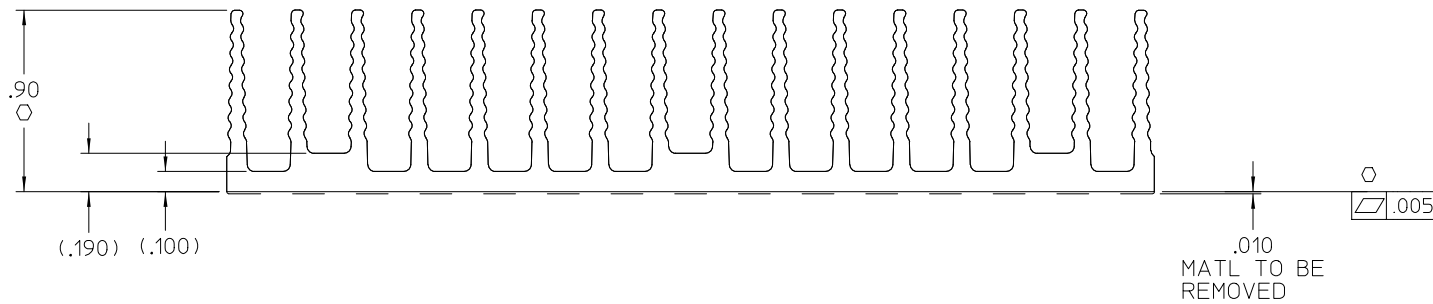

REV.	DESCRIPTION	DATE	APPROVED
1	RELEASED PER E050350	11/16/05	EF
2	REVISED PER E091652	09/11/09	REJH

○
#4-40 UNC-2B COLD FORM TAP
.140 DP MIN, FROM FAR SIDE
DO NOT BREAK THRU
(6) PL.

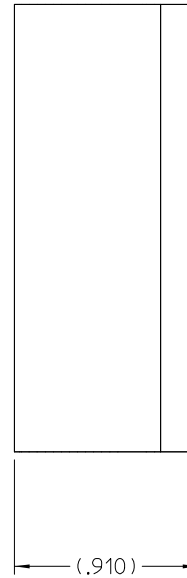
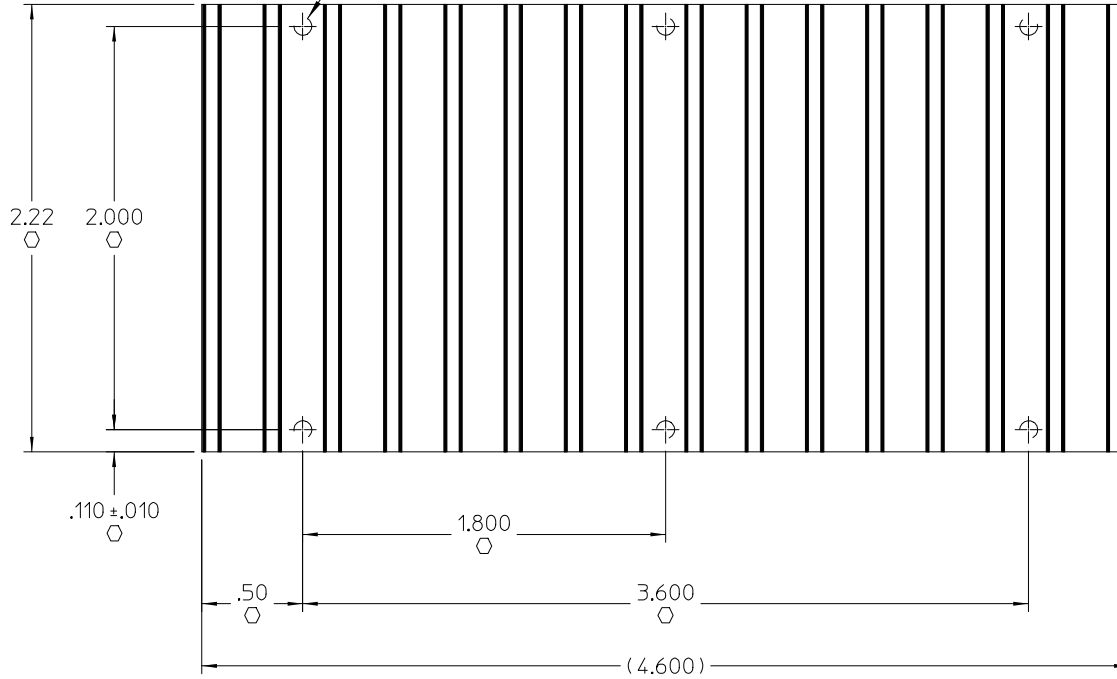

NOTES

1. MATERIAL: EXTRUSION SEE SHEET 2 OF 2.
2. REMOVE ALL BURRS AND SHARP EDGES.
- 3. CLEAR FINISH, RoHS COMPLIANT, CHROMIUM FREE PER CST-0001 LATEST REVISION.
4. "○" DENOTES CRITICAL CHARACTERISTIC FOR LOT INSPECTION.

DRAWN BY <i>P.E.IENI</i>	DATE 06/30/05	 HS CFG "A", .90H, X-FLOW, LOW FLOW, THREADED		
<small>UNLESS OTHERWISE SPECIFIED DIMENSIONS ARE IN INCHES- TOLERANCES ARE: FRACTIONS DECIMALS ANGLES +1/64 .XX+ .01 *1° .XXX-.005</small>				
THIRD ANGLE PROJECTION 	SIZE C	CAGE CODE 67131	DWG NO 30196	REV 2
DO NOT SCALE DRAWING	SCALE 2:1	SHEET 1 OF 2		

THIS DOCUMENT AND THE DATA DISCLOSED HEREIN OR HEREWITH IS NOT TO BE REPRODUCED, USED, OR DISCLOSED IN WHOLE OR IN PART TO ANYONE WITHOUT PERMISSION OF VICOR CORP.

REV.	DESCRIPTION	DATE	APPROVED
	SEE SHEET 1 OF 2		

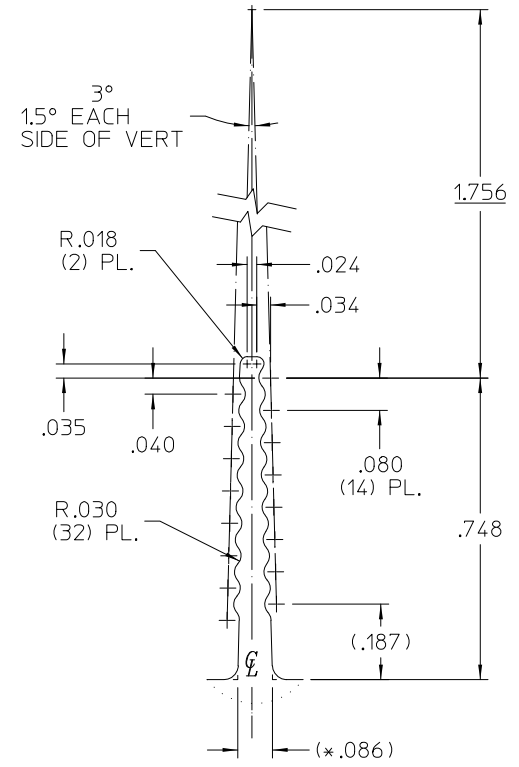
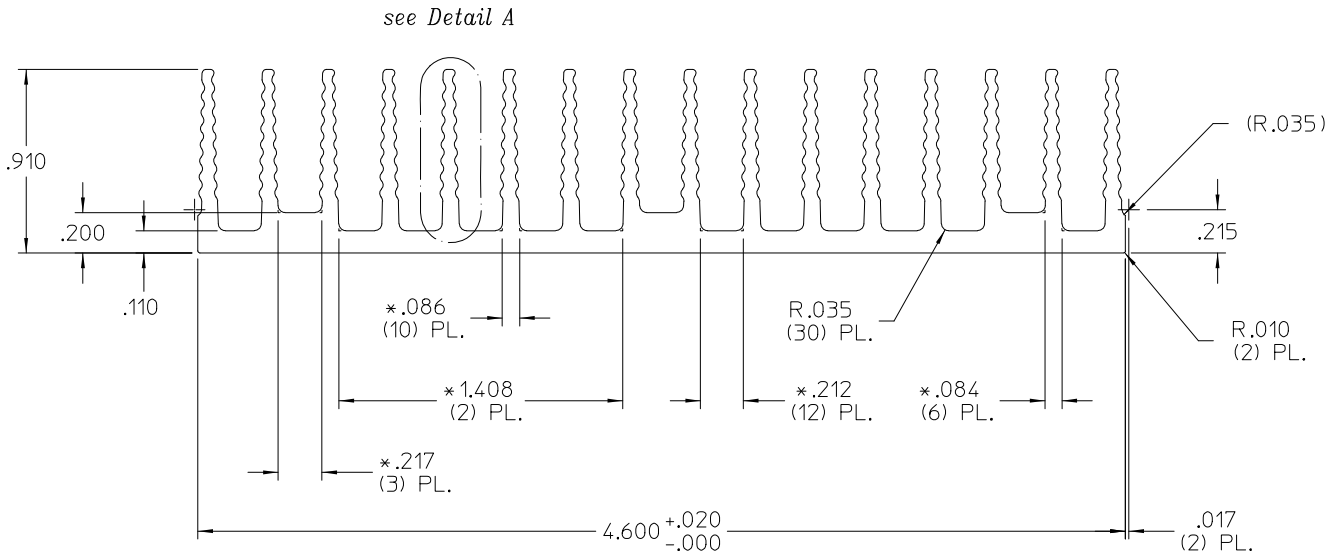

Detail A
Scale 4:1

PROFILE COMMON FOR
30196
30723

NOTES:

- MATL: ALUMINUM 6063-T5
- * DENOTES DIMENSION TO THEORETICAL SHARP CORNER.
- ALL DIMENSIONS ARE CRITICAL CHARACTERISTICS.
- RoHS COMPLIANT PER CST-0001 LATEST REVISION.
- WORKMANSHIP STANDARDS WS-0004, WS-0006 AND WS-0007 APPLY TO THIS PART.

DRAWN BY JSARIPELLA		DATE 9/11/09			
UNLESS OTHERWISE SPECIFIED DIMENSIONS ARE IN INCHES. TOLERANCES ARE: FRACTIONS DECIMALS ANGLES +1/64 .XX+ .01 *1° .XXX-.005					
THIRD ANGLE PROJECTION 		SIZE C	CAGE CODE 67131	DWG NO 30196	REV 2
DO NOT SCALE DRAWING		SCALE 2:1	SHEET 2 OF 2		