

Features

- Auto-sense
- Non-Isolated
- Synchronous rectification design
- Adjustable Output voltage
- 2, 3, 4 & 5AMP Adjustable Positive Step Down Integrated Switching Regulator
- Over load protection (125% full load typical)
- Remote ON/OFF Control(Ground Off)
- Wide Input Range
- UL94V-0 Package Material
- Continuous short circuit protection (Short Circuit Input Current, $I_{in\ sc} < 50mA$)
- Input voltage range 4.5V~18V
- Efficiency to 96 %

Description

The R-5XXX series is a high performance 1.2V to 5.0V , 2Amp to 5Amp, 12-Pin SIP (single in-line package) integrated switching regulator (ISR). Synchronous - rectified design yields excellent efficiencies up to 96%. Short circuit protection with crowbar function to reduce the short circuit input current to under 50mA. Autosense function compensates for any losses in long circuit loops.

Selection Guide

Part Number SIP12	Input Range (V)	Nominal Output Voltage (V)	Vout Adjust Range (V)	Output Current (A)	Efficiency		
					min.Vin (%)	12V (%)	max.Vin (%)
R-521.2xA	4.5 – 18	1.2	1.0 – 3.0	2	83	79	75
R-521.8xA	4.5 – 18	1.8	1.1 – 4.5	2	88	85	82
R-522.5xA	4.5 – 18	2.5	1.6 – 5.5	2	91	88	86
R-523.3xA	4.5 – 18	3.3	1.6 – 5.5	2	92	90	89
R-525.0xA	6.5 – 18	5.0	3.0 – 5.5	2	95	93	92
R-531.2xA	4.5 – 18	1.2	1.0 – 3.0	3	85	84	82
R-531.8xA	4.5 – 18	1.8	1.1 – 4.5	3	89	88	86
R-532.5xA	4.5 – 18	2.5	1.6 – 5.5	3	92	91	89
R-533.3xA	4.5 – 18	3.3	1.6 – 5.5	3	94	93	92
R-535.0xA	6.5 – 18	5.0	3.0 – 5.5	3	96	95	94
R-541.2xA	4.5 – 18	1.2	1.0 – 3.0	4	82	81	79
R-541.8xA	4.5 – 18	1.8	1.1 – 4.5	4	87	86	85
R-542.5xA	4.5 – 18	2.5	1.6 – 5.5	4	91	89	88
R-543.3xA	4.5 – 18	3.3	1.6 – 5.5	4	93	92	91
R-545.0xA	6.5 – 18	5.0	3.0 – 5.5	4	95	94	93
R-551.2xA	4.5 – 18	1.2	1.0 – 3.0	5	81	80	78
R-551.8xA	4.5 – 18	1.8	1.1 – 4.5	5	86	85	84
R-552.5xA	4.5 – 18	2.5	1.6 – 5.5	5	90	89	88
R-553.3xA	4.5 – 18	3.3	1.6 – 5.5	5	92	91	90
R-555.0xA	7.0 – 18	5.0	3.0 – 5.5	5	94	93	92

Note: $V_{in} - V_{out} \geq 1.5V$ if adjust function is used!

Suffix x: (see mechanical drawing for details)

x = P pins vertical through hole

x = D pins bent for horizontal through hole mounting

INNOLINE
DC/DC-Converter
with 3 year Warranty

RECOM

2, 3, 4, 5 AMP
SIP12
Vertical &
Horizontal



EN-60950-1 Certified

R-5xxxA

Specifications (refer to the standard application circuit, Ta: 25°C)

Characteristics	Conditions	Min.	Typ.	Max.
Output Voltage Range	All Series	0.8		6.0V
Output Current	R-52xxPA/DA R-53xxPA/DA R-54xxPA/DA R-55xxPA/DA	0.2 0.3 0.4 0.5		2.0A 3.0A 4.0A 5.0A
Output Current Limit	R-52xxPA/DA R-53xxPA/DA R-54xxPA/DA R-55xxPA/DA		2.5 3.75 5.0 6.0	3.0A 4.25A 5.5A 6.5A
Short Circuit Input Current	All Series			50mA
Short Circuit Protection			Continuous, automatic recovery	
Output Voltage Accuracy	At 100% Load All Series		±1%	±2%
Line Voltage Regulation (Vin = min. to max. at full load)	R-52xxPA/DA R-53xxPA/DA & R-54xxPA/DA & R-55xxPA/DA		0.25 0.5	0.5% 1.0%
Load Regulation (10 to 100% full load)	R-52xxPA/DA R-53xxPA/DA & R-54xxPA/DA & R-55xxPA/DA		0.5 1.0	1.0% 2.0%
Ripple & Noise	R-52xxPA/DA R-53xxPA/DA & R-54xxPA/DA & R-55xxPA/DA		40mVp-p 80mVp-p	70mVp-p 120mVp-p
Transient Response (see note 1)	50% Load Change Vout Over / Undershoot		100µs	200µs 100mV
Remote ON / OFF (see note 2) (positive logic)	Open or High (Power ON) Low (Power OFF)	4.5		18V 0.8V
Remote Off Input Current	Remote ON/OFF low level			100µA
Max capacitance Load	with normal start-up time, no external diodes with <1 second start up time + diode protection circuit			300µF 6800µF
Switching Frequency		270	300	330kHz
Quiescent Current	Vin = min. to max. at 0% load			20mA
Operating Temperature Range		-40°C		+85°C
Storage Temperature Range		-40°C		+125°C
Case Material				Non-Conductive Black Plastic
Potting Material				Epoxy (UL94V-0)
Internal Power Dissipation	Io x Vo x (1-Efficiency)			1.4W
Package Weight				9g
Packing Quantity				15 pcs per Tube
MTBF (Nominal Vout, 100% load)	Tamb. = +25°C Tamb. = +85°C	} Detailed Information see Application Notes chapter "MTBF"		749 x 10 ³ hours 150 x 10 ³ hours

Notes:

- Requires an electrolytic or tantalum output capacitor for proper operation in all applications (the capacitor to be placed as close as possible to the output pins) 100µF for R-52xxPA/DA, R-53xxPA/DA and R-54xxPA/DA or 220µF for R-55xxPA/DA.
- ON / OFF pin driven by TTL (logic gate), open-collector bipolar transistor or open-drain MOSFET.
- Output Current vs. Input Voltage (see graph below).

Output Current vs Input Voltage

How to calculate the max output current

The internal power dissipation(P_D)follows the equation:

$$P_D = I_o \times V_o \times (1-\eta)$$

$$I_o = P_D / V_o \times (1-\eta)$$

Where P_D = Internal power dissipation
I_o = Output current
V_o = Output voltage
η = Efficiency

Example: R-545.0P , at Vin = 18Vdc , Vo = 5Vdc , η=93% (see "Selection Guide" table)

(a) When Ta = 60°C , P_D = 1.4 Watt (see adjacent diagram)

$$I_o = 1.4(W) / 5(V) \times (1-0.93) = 4(A)$$

(b) When Ta = 85°C , P_D = 1 Watt (see adjacent diagram)

$$I_o = 1(W) / 5(V) \times (1-0.93) = 2.857(A)$$

(c) At Vin = 12Vdc efficiency = 94% (see "Selection Guide" table)

When Ta = 85°C , P_D = 1 Watt (see adjacent diagram)

$$I_o = 1(W) / 5(V) \times (1-0.94) = 3.33(A)$$

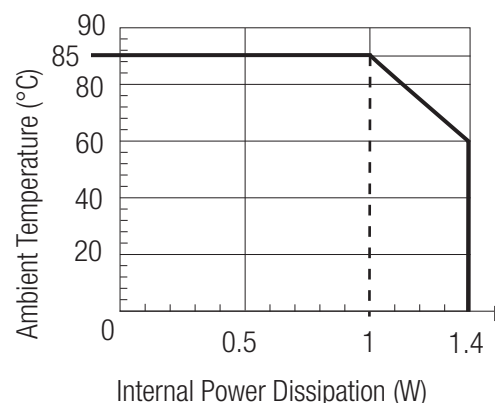

Standard Application Circuit

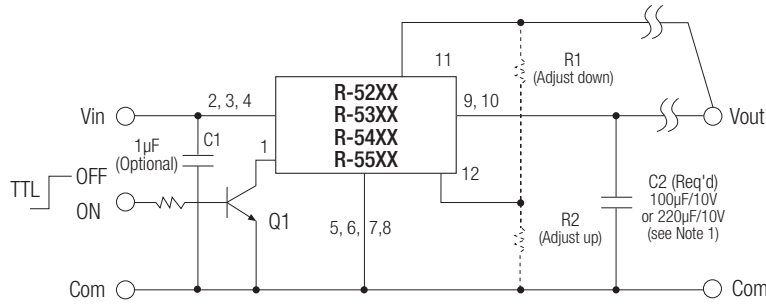

Add a blocking diode to Vout if current can flow backwards into the output, as this can damage the converter..

Parallel Application Circuit

The R-52xx, R-53xx, R-54xx series can be used in parallel to upgrade the output current capacity for the same output voltage.

For example, the R-543.3PA can parallel up with another R-554.3PA to give up to 8 amps or with the R-533.3PA or R-523.3PA types to give output currents of up to 7 Amps or 6 Amps.

The R-55xx series cannot be paralleled.

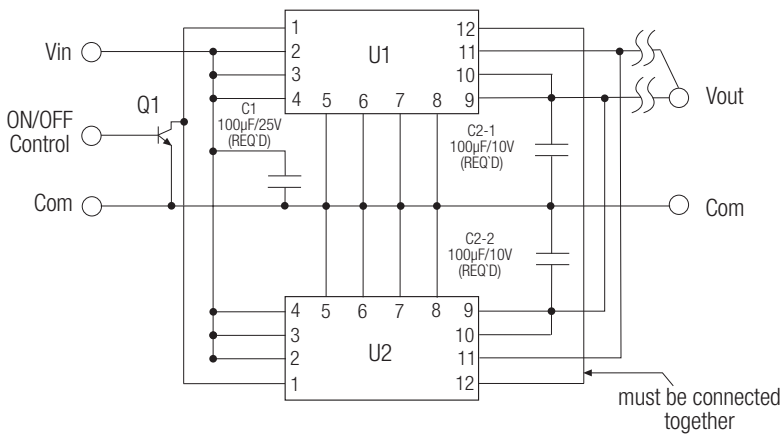

R-5xxxA

Component side

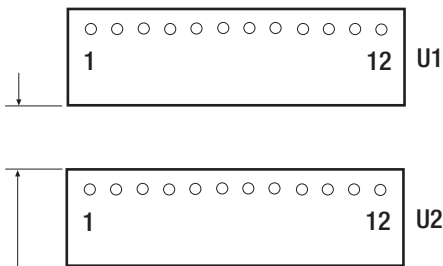

Keep 2mm to 5mm distance between both converters

Solder side

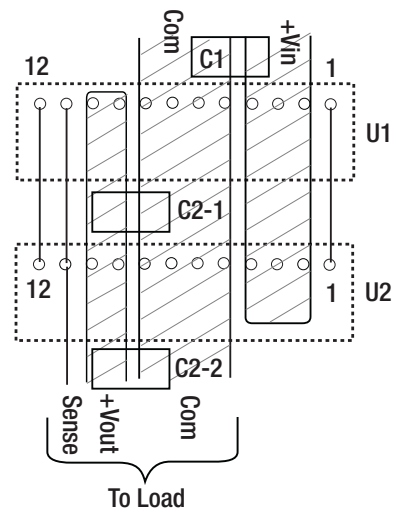

Characteristics

R-53xx / R-54xx
Output Voltage Line Regulation VS Vout

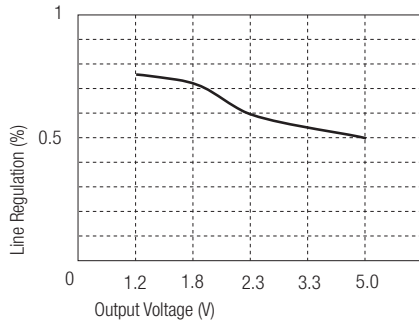

R-52xx / R-55xx
Output Voltage Line Regulation VS Vout

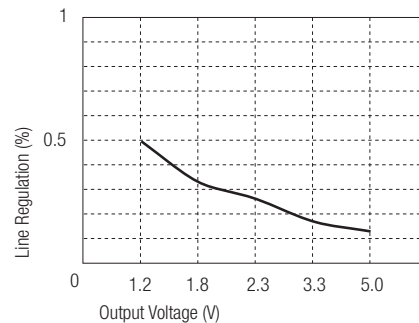

R-53xx / R-54xx
Input Voltage Load Regulation VS Vin

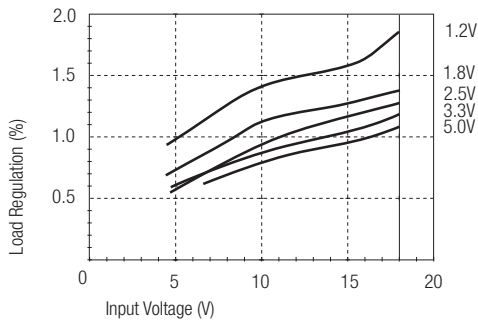

R-52xx / R-55xx
Input Voltage Load Regulation VS Vin

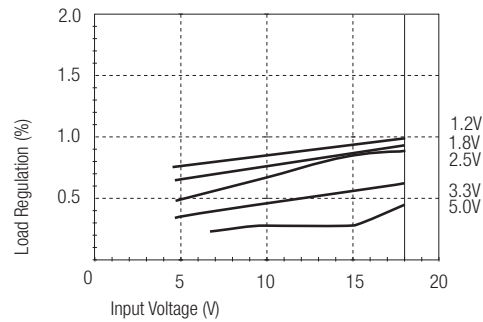

R-53xx / R-54xx / R-55xx
Output Current Efficiency vs I_{out} (Vin = Min)

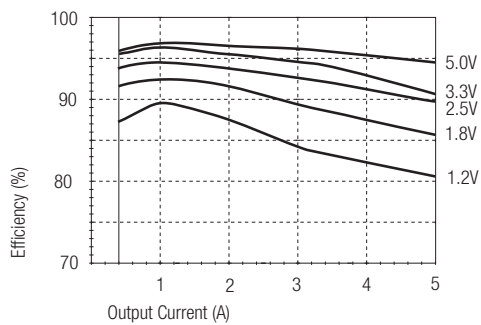

R-52xx
Output Current Efficiency vs I_{out} (Vin = Min)

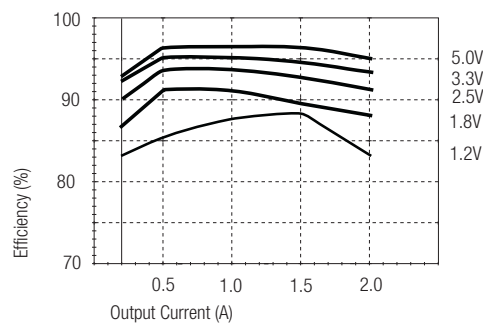

R-53xx / R-54xx / R-55xx
Output Current Efficiency vs I_{out} (Vin = 18V)

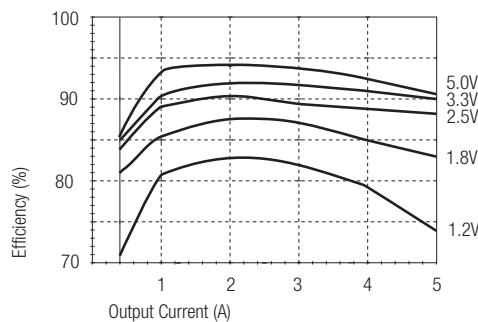

R-52xx
Output Current Efficiency VS I_{out} (Vin = 18V)

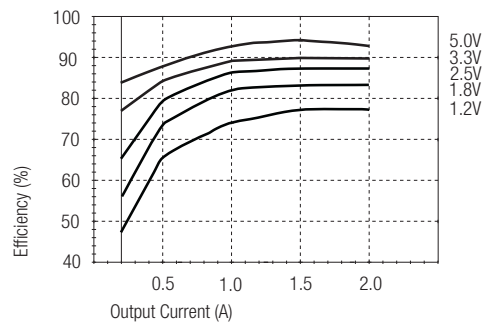

R-5xxxxA

Table 1: Adjustment Resistor Values

2Adc	R-521.2PA/DA		R-521.8PA/DA		R-522.5PA/DA		R-523.3PA/DA		525.0PA/DA	
3Adc	R-531.2PA/DA		R-531.8PA/DA		R-532.5PA/DA		R-533.3PA/DA		535.0PA/DA	
4Adc	R-541.2PA/DA		R-541.8PA/DA		R-542.5PA/DA		R-543.3PA/DA		545.0PA/DA	
5Adc	R-541.2PA/DA		R-541.8PA/DA		R-542.5PA/DA		R-543.3PA/DA		545.0PA/DA	
Vout (nominal)	1.2Vdc		1.8Vdc		2.5Vdc		3.3Vdc		5.0Vdc	
Vout (adj)	R1	R2	R1	R2	R1	R2	R1	R2	R1	R2
0.8 (V)										
0.9 (V)	740Ω									
1.0 (V)	3.9KΩ									
1.1 (V)	13KΩ		1.05KΩ							
1.2 (V)			2.1KΩ	270Ω						
1.3 (V)		37KΩ	3.7KΩ		750Ω					
1.5 (V)		11.5KΩ	10KΩ		2.1KΩ		390Ω			
1.6 (V)		8.2KΩ	18KΩ		3.0KΩ		750Ω			
1.7 (V)		6.5KΩ	41KΩ		4.1KΩ		1.2KΩ			
1.8 (V)		5.2KΩ			5.6KΩ		1.7KΩ			
1.9 (V)		4.3KΩ		36KΩ	7.5KΩ		2.2KΩ			
2.0 (V)		3.6KΩ		1.8KΩ	10.5KΩ		2.8KΩ			
2.4 (V)		2.1KΩ		5.2KΩ	82KΩ		6.8KΩ			
2.5 (V)		1.8KΩ		4.3KΩ			8.5KΩ			
2.6 (V)		1.65KΩ		3.6KΩ		33KΩ	10.5KΩ			
3.0 (V)		1.05KΩ		2.1KΩ		6.2KΩ	33KΩ		470Ω	
3.2 (V)				1.65KΩ		4.1KΩ	110KΩ		1.6KΩ	
3.3 (V)				1.5KΩ		3.4KΩ			2.2KΩ	
3.4 (V)				1.35KΩ		2.9KΩ		36KΩ	3.0KΩ	
3.6 (V)				1.07KΩ		2.2KΩ		11KΩ	4.7KΩ	
3.9 (V)				780Ω		1.4KΩ		4.7KΩ	8.5KΩ	
4.5 (V)				390Ω		650Ω		1.6KΩ	30KΩ	
4.9 (V)						350Ω		820Ω	220KΩ	
5.0 (V)						290Ω		680Ω		
5.1 (V)						220Ω		560Ω		28KΩ
5.5 (V)						39Ω		190Ω		2.6KΩ

R-5xxxA

Package Style and Pinning (mm)

SIP12 PIN Package

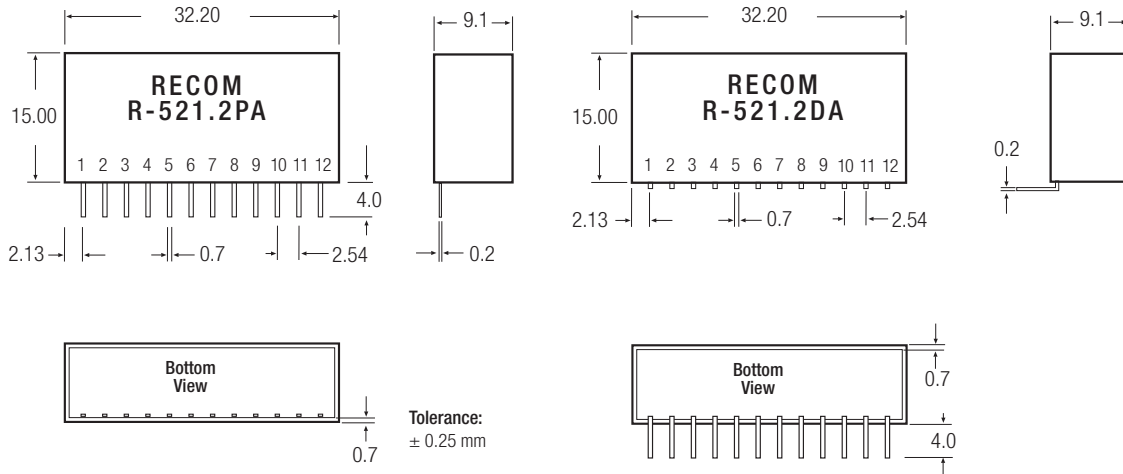

Pin Connections

Pin #	Name	Description
1	ON / OFF	Input pin : Active low (less than 0.8V) to disable the device
2, 3, 4	Vin	Power input
5, 6, 7, 8	GND	Input and output ground (common)
9, 10	Vout	Power output
11	Vout (Auto Sense)	If unused this pin must be connected to Pin 9 and 10
12	Vout-Adj	With external resistors R1,R2 to selected output voltage

R-5xxxPA

Optional Diode Protection Circuit

Optional Protection 1:

Add a blocking diode to Vout if current can flow backwards into the output, as this can damage the converter when it is powered down. Protection diodes are required for high capacitive loads.

The diode can either be fitted across the device if the source is low impedance or fitted in series with the output (recommended).

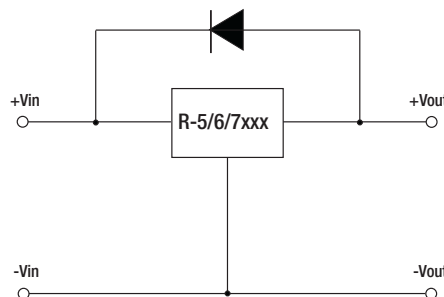

Optional Protection 2:

