

12V Austin Lynx™ SIP Non-isolated Power Modules, Programmable: 10Vdc – 14Vdc input; 0.75Vdc to 5.5Vdc Output; 10A Output Current

RoHS Compliant

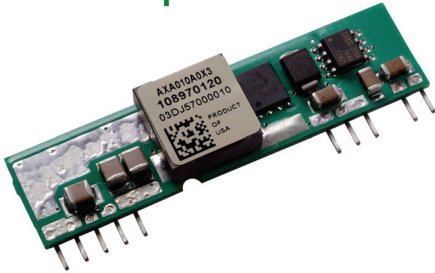

Applications

- Distributed power architectures
- Intermediate bus voltage applications
- Telecommunications equipment
- Servers and storage applications
- Networking equipment
- Enterprise Networks
- Latest generation IC's (DSP, FPGA, ASIC) and Microprocessor powered applications

Description

The 12V Austin Lynx™ Programmable SIP power modules are non-isolated dc-dc converters that can deliver up to 10A of output current with full load efficiency of 93% at 3.3V output. These modules provide a precisely regulated output voltage ranging from 0.75Vdc to 5.5Vdc, programmable via an external resistor over a wide range of input voltage ($V_{IN} = 10 - 14Vdc$). Their open-frame construction and small footprint enable designers to develop cost- and space-efficient solutions. Standard features include remote On/Off, remote sense, output voltage adjustment, overcurrent and overtemperature protection.

Features

- Compliant to RoHS EU Directive 2002/95/EC (-Z versions)
- Compliant to ROHS EU Directive 2002/95/EC with lead solder exemption (non-Z versions)
- Delivers up to 10A output current
- High efficiency – 93% at 3.3V full load ($V_{IN} = 12.0V$)
- Small size and low profile:
50.8 mm x 12.7 mm x 8.10 mm
(2.00 in x 0.5 in x 0.32 in)
- Low output ripple and noise
- High Reliability:
Calculated MTBF = 4.4 M hours at 25°C Full-load
- Constant switching frequency (300 kHz)
- Output voltage programmable from 0.75 Vdc to 5.5Vdc via external resistor
- Line Regulation: 0.3% (typical)
- Load Regulation: 0.4% (typical)
- Temperature Regulation: 0.4 % (typical)
- Remote On/Off
- Remote Sense
- Over temperature protection
- Output overcurrent protection (non-latching)
- Wide operating temperature range (-40°C to 85°C)
- UL* 60950-1 Recognized, CSA† C22.2 No. 60950-1-03 Certified, and VDE‡ 0805:2001-12 (EN60950-1) Licensed
- ISO** 9001 and ISO 14001 certified manufacturing facilities

* UL is a registered trademark of Underwriters Laboratories, Inc.

† CSA is a registered trademark of Canadian Standards Association.

‡ VDE is a trademark of Verband Deutscher Elektrotechniker e.V.

** ISO is a registered trademark of the International Organization of Standards

Absolute Maximum Ratings

Stresses in excess of the absolute maximum ratings can cause permanent damage to the device. These are absolute stress ratings only, functional operation of the device is not implied at these or any other conditions in excess of those given in the operations sections of the data sheet. Exposure to absolute maximum ratings for extended periods can adversely affect the device reliability.

Parameter	Device	Symbol	Min	Max	Unit
Input Voltage Continuous	All	V_{IN}	-0.3	15	Vdc
Operating Ambient Temperature (see Thermal Considerations section)	All	T_A	-40	85	°C
Storage Temperature	All	T_{stg}	-55	125	°C

Electrical Specifications

Unless otherwise indicated, specifications apply over all operating input voltage, resistive load, and temperature conditions.

Parameter	Device	Symbol	Min	Typ	Max	Unit
Operating Input Voltage	All	V_{IN}	10.0	12.0	14.0	Vdc
Maximum Input Current ($V_{IN} = V_{IN, min}$ to $V_{IN, max}$; $I_O = I_{O, max}$; $V_{O, set} = 3.3Vdc$)	All	$I_{IN, max}$			6.5	Adc
Input No Load Current ($V_{IN} = 12.0Vdc$, $I_O = 0$, module enabled)	$V_{O, set} = 0.75Vdc$	$I_{IN, No load}$		40		mA
	$V_{O, set} = 5.0Vdc$	$I_{IN, No load}$		100		mA
Input Stand-by Current ($V_{IN} = 12.0Vdc$, module disabled)	All	$I_{IN, stand-by}$		2.0		mA
Inrush Transient	All	I^2t			0.5	A ² s
Input Reflected Ripple Current, peak-to-peak (5Hz to 20MHz, 1μH source impedance; $V_{IN, min}$ to $V_{IN, max}$; $I_O = I_{O, max}$; See Test configuration section)	All			20		mAp-p
Input Ripple Rejection (120Hz)	All			30		dB

CAUTION: This power module is not internally fused. An input line fuse must always be used.

This power module can be used in a wide variety of applications, ranging from simple standalone operation to being part of a complex power architecture. To preserve maximum flexibility, internal fusing is not included, however, to achieve maximum safety and system protection, always use an input line fuse. The safety agencies require a 15A, time-delay fuse (see Safety Considerations section). Based on the information provided in this data sheet on inrush energy and maximum dc input current, the same type of fuse with a lower rating can be used. Refer to the fuse manufacturer's data sheet for further information.

Electrical Specifications (continued)

Parameter	Device	Symbol	Min	Typ	Max	Unit
Output Voltage Set-point ($V_{IN}=V_{IN, min}$, $I_O=I_{O, max}$, $T_A=25^\circ\text{C}$)	All	$V_{O, set}$	-2.0	$V_{O, set}$	+2.0	% $V_{O, set}$
Output Voltage (Over all operating input voltage, resistive load, and temperature conditions until end of life)	All	$V_{O, set}$	-2.5%	—	+3%	% $V_{O, set}$
Adjustment Range Selected by an external resistor	All	V_O	0.7525		5.5	Vdc
Output Regulation Line ($V_{IN}=V_{IN, min}$ to $V_{IN, max}$) Load ($I_O=I_{O, min}$ to $I_{O, max}$) Temperature ($T_{ref}=T_{A, min}$ to $T_{A, max}$)	All All All		— — —	0.3 0.4 0.4	— — —	% $V_{O, set}$ % $V_{O, set}$ % $V_{O, set}$
Output Ripple and Noise on nominal output ($V_{IN}=V_{IN, nom}$ and $I_O=I_{O, min}$ to $I_{O, max}$ Cout = 1 μF ceramic//10 μF tantalum capacitors)						
RMS (5Hz to 20MHz bandwidth)	All		—	12	15	mV _{rms}
Peak-to-Peak (5Hz to 20MHz bandwidth)	All		—	30	50	mV _{pk-pk}
External Capacitance ESR $\geq 1 \text{ m}\Omega$ ESR $\geq 10 \text{ m}\Omega$	All All	$C_{O, max}$ $C_{O, max}$	— —	— —	1000 5000	μF μF
Output Current	All	I_O	0		10	Adc
Output Current Limit Inception (Hiccup Mode) ($V_O=90\%$ of $V_{O, set}$)	All	$I_{O, lim}$	—	200	—	% I_O
Output Short-Circuit Current ($V_O \leq 250\text{mV}$) (Hiccup Mode)	All	$I_{O, s/c}$	—	3	—	Adc
Efficiency $V_{IN} = V_{IN, nom}$, $T_A=25^\circ\text{C}$ $I_O=I_{O, max}$, $V_O = V_{O, set}$	$V_{O, set} = 0.75\text{Vdc}$ $V_{O, set} = 1.2\text{Vdc}$ $V_{O, set} = 1.5\text{Vdc}$ $V_{O, set} = 1.8\text{Vdc}$ $V_{O, set} = 2.5\text{Vdc}$ $V_{O, set} = 3.3\text{Vdc}$ $V_{O, set} = 5.0\text{Vdc}$	η η η η η η η		81.0 87.5 89.0 90.0 92.0 93.0 95.0		% % % % % % %
Switching Frequency	All	f_{sw}	—	300	—	kHz
Dynamic Load Response ($dI_O/dt=2.5\text{A}/\mu\text{s}$; $V_{IN} = V_{IN, nom}$; $T_A=25^\circ\text{C}$) Load Change from $I_O=50\%$ to 100% of $I_{O, max}$; 1 μF ceramic// 10 μF tantalum Peak Deviation Settling Time ($V_O < 10\%$ peak deviation)	All All	V_{pk} t_s	— —	200 25	— —	mV μs
($dI_O/dt=2.5\text{A}/\mu\text{s}$; $V_{IN} = V_{IN, nom}$; $T_A=25^\circ\text{C}$) Load Change from $I_O=100\%$ to 50% of $I_{O, max}$: 1 μF ceramic// 10 μF tantalum Peak Deviation Settling Time ($V_O < 10\%$ peak deviation)	All All	V_{pk} t_s	— —	200 25	— —	mV μs

Electrical Specifications (continued)

Parameter	Device	Symbol	Min	Typ	Max	Unit
Dynamic Load Response ($dI_o/dt=2.5A/\mu s$; $V_{IN} = V_{IN, nom}$; $T_A=25^\circ C$) Load Change from $I_o= 50\%$ to 100% of $I_{o,max}$; $C_o = 2 \times 150 \mu F$ polymer capacitors Peak Deviation	All	V_{pk}	—	100	—	mV
Settling Time ($V_o < 10\%$ peak deviation)	All	t_s	—	25	—	μs
($dI_o/dt=2.5A/\mu s$; $V_{IN} = V_{IN, nom}$; $T_A=25^\circ C$) Load Change from $I_o= 100\%$ to 50% of $I_{o,max}$; $C_o = 2 \times 150 \mu F$ polymer capacitors Peak Deviation	All	V_{pk}	—	100	—	mV
Settling Time ($V_o < 10\%$ peak deviation)	All	t_s	—	25	—	μs

General Specifications

Parameter	Min	Typ	Max	Unit
Calculated MTBF ($I_o=I_{o, max}$, $T_A=25^\circ C$)		4,400,000		Hours
Weight	—	5.6 (0.2)	—	g (oz.)

Feature Specifications

Unless otherwise indicated, specifications apply over all operating input voltage, resistive load, and temperature conditions. See Feature Descriptions for additional information.

Parameter	Device	Symbol	Min	Typ	Max	Unit
On/Off Signal interface (On/Off is open collector/drain logic input; Signal referenced to GND - See feature description section)						
Input High Voltage (Module ON)	All	V_{IH}	—	—	$V_{IN,max}$	V
Input High Current	All	I_{IH}	—	—	10	μA
Input Low Voltage (Module OFF)	All	V_{IL}	—	—	0.3	V
Input Low Current	All	I_{IL}	—	—	1	mA
Turn-On Delay and Rise Times ($I_O=I_{O,max}$, $V_{IN}=V_{IN,nom}$, $T_A=25^\circ C$)						
Case 1: On/Off input is set to Logic Low (Module ON) and then input power is applied (delay from instant at which $V_{IN} = V_{IN,min}$ until $V_O=10\%$ of $V_{O,set}$)	All	Tdelay	—	3	—	msec
Case 2: Input power is applied for at least one second and then the On/Off input is set to logic Low (delay from instant at which $V_{on/off}=0.3V$ until $V_O=10\%$ of $V_{O,set}$)	All	Tdelay	—	3	—	msec
Output voltage Rise time (time for V_O to rise from 10% of $V_{O,set}$ to 90% of $V_{O,set}$)	All	Trise	—	4	6	msec
Output voltage overshoot – Startup $I_O=I_{O,max}$; $V_{IN}=10.0$ to $14.0Vdc$, $T_A=25^\circ C$				—	1	% $V_{O,set}$
Remote Sense Range			—	—	0.5	V
Overtemperature Protection (See Thermal Consideration section)	All	T_{ref}	—	125	—	$^\circ C$
Input Undervoltage Lockout						
Turn-on Threshold	All			8.2		V
Turn-off Threshold	All			8.0		V

Characteristic Curves

The following figures provide typical characteristics for the 12V Austin Lynx Programmable SIP modules at 25°C.

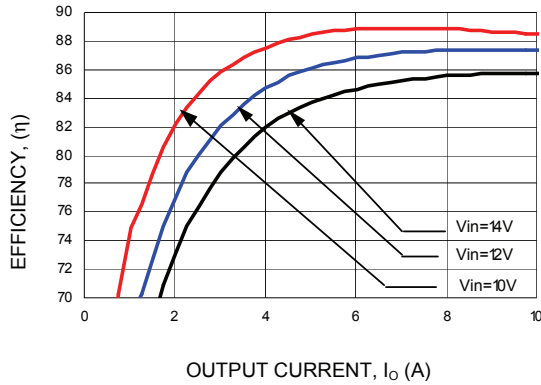

Figure 1. Converter Efficiency versus Output Current (Vout = 0.75Vdc).

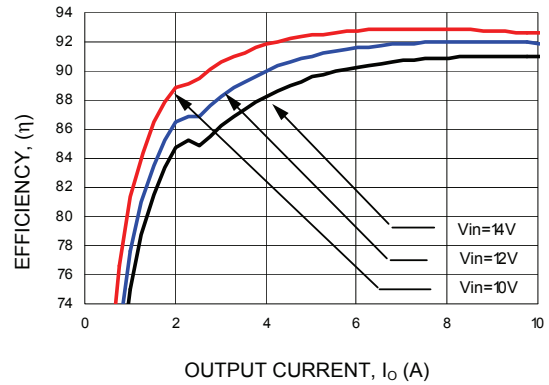

Figure 4. Converter Efficiency versus Output Current (Vout = 2.5Vdc).

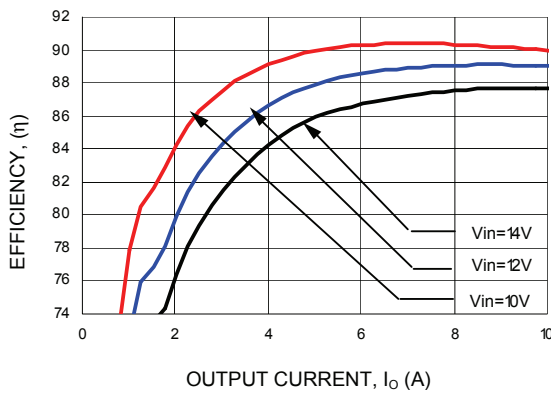

Figure 2. Converter Efficiency versus Output Current (Vout = 1.5Vdc).

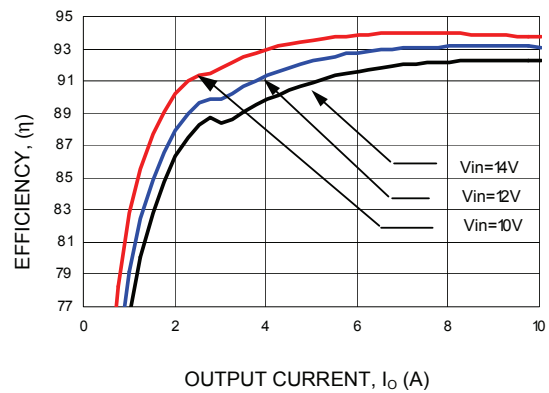

Figure 5. Converter Efficiency versus Output Current (Vout = 3.3Vdc).

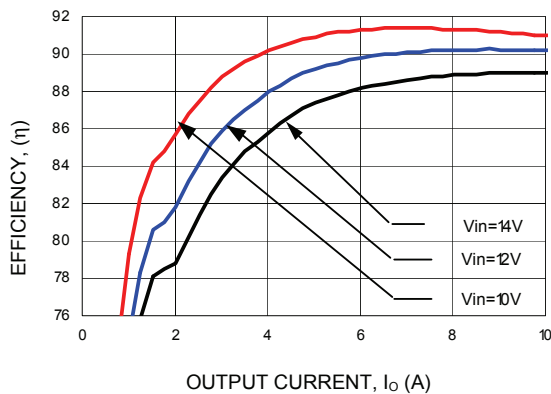

Figure 3. Converter Efficiency versus Output Current (Vout = 1.8Vdc).

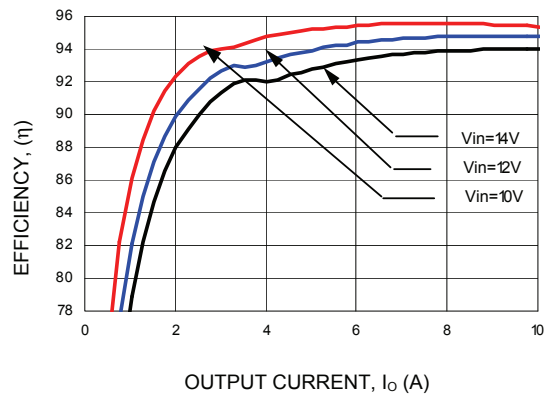

Figure 6. Converter Efficiency versus Output Current (Vout = 5.0Vdc).

Characteristic Curves (continued)

The following figures provide typical characteristics for the 12V Austin Lynx Programmable SIP modules at 25°C.

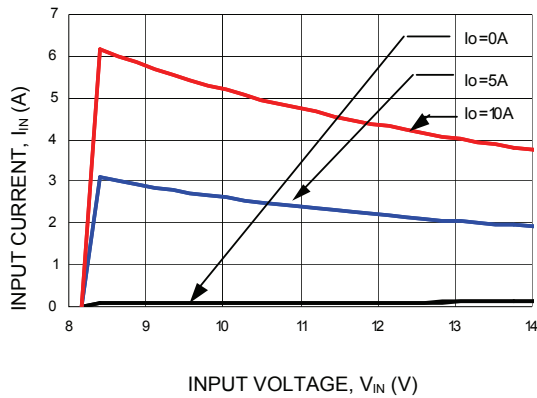

Figure 7. Input voltage vs. Input Current ($V_o = 2.5Vdc$).

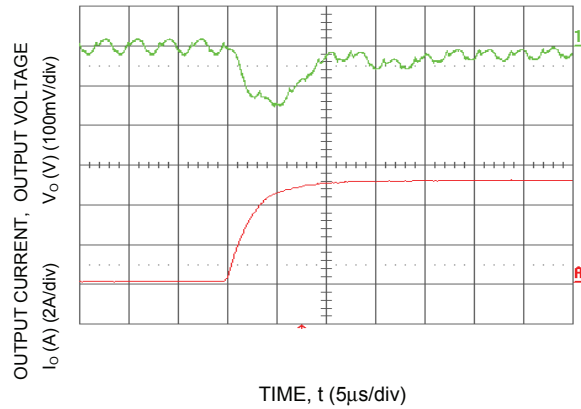

Figure 10. Transient Response to Dynamic Load Change from 50% to 100% of full load ($V_o = 5.0Vdc$).

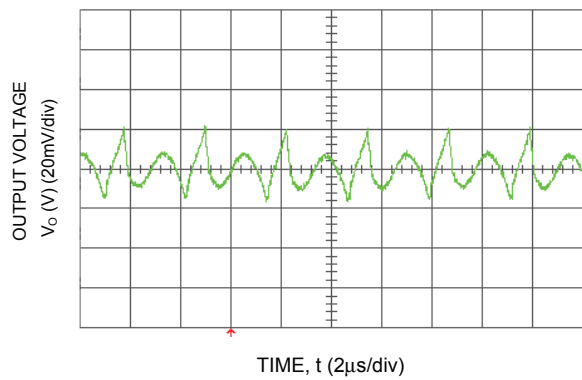

Figure 8. Typical Output Ripple and Noise ($V_{in} = 12V$ dc, $V_o = 2.5, Vdc$, $I_o = 10A$).

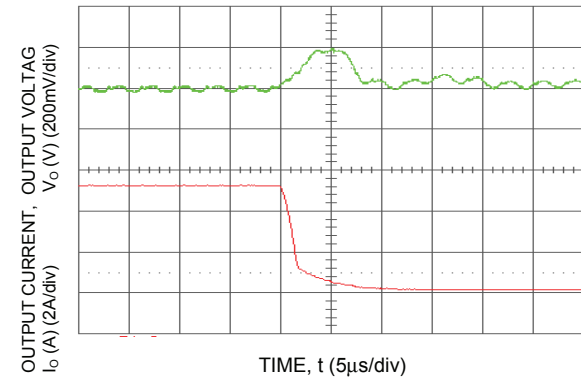

Figure 11. Transient Response to Dynamic Load Change from 100% to 50% of full load ($V_o = 5.0 Vdc$).

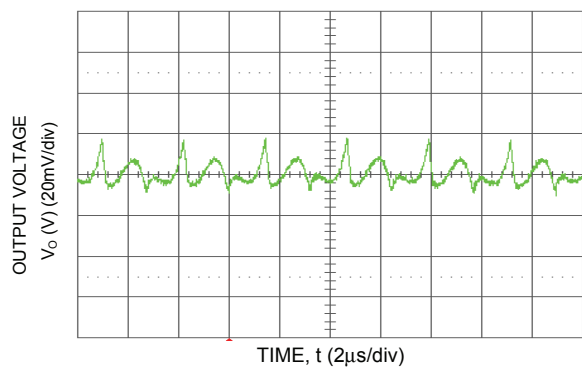

Figure 9. Typical Output Ripple and Noise ($V_{in} = 12V$ dc, $V_o = 5.0 Vdc$, $I_o = 10A$).

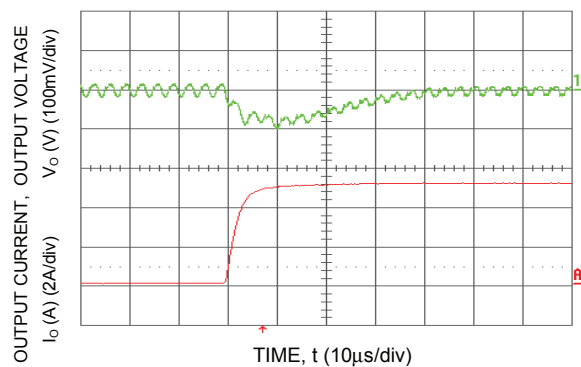

Figure 12. Transient Response to Dynamic Load Change from 50% to 100% of full load ($V_o = 5.0 Vdc$, $C_{ext} = 2 \times 150 \mu F$ Polymer Capacitors).

Characteristic Curves (continued)

The following figures provide typical characteristics for the 12V Austin Lynx Programmable SIP modules at 25°C.

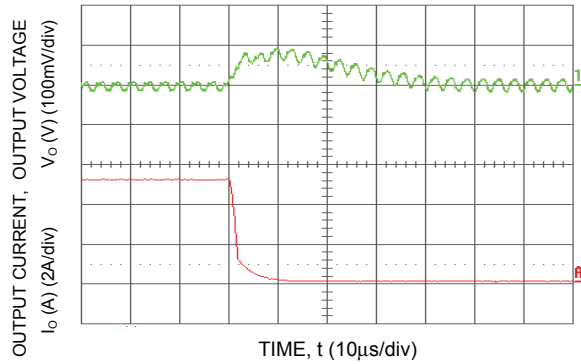

Figure 13. Transient Response to Dynamic Load Change from 100% of 50% full load ($V_o = 5.0\text{ Vdc}$, $C_{ext} = 2 \times 150\ \mu\text{F}$ Polymer Capacitors).

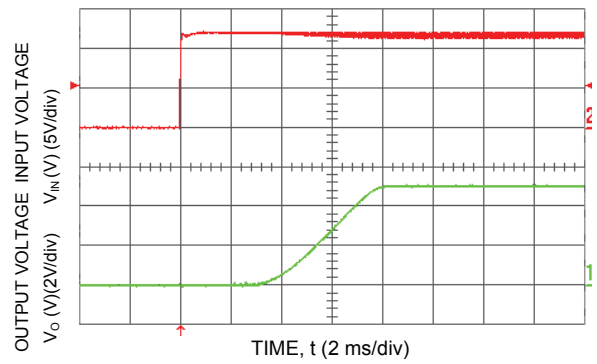

Figure 16. Typical Start-Up with application of V_{in} ($V_{in} = 12\text{Vdc}$, $V_o = 5.0\text{Vdc}$, $I_o = 10\text{A}$).

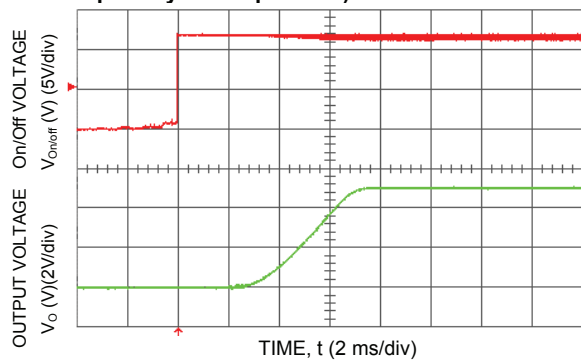

Figure 14. Typical Start-Up Using Remote On/Off ($V_{in} = 12.0\text{ Vdc}$, $V_o = 5.0\text{Vdc}$, $I_o = 10\text{A}$).

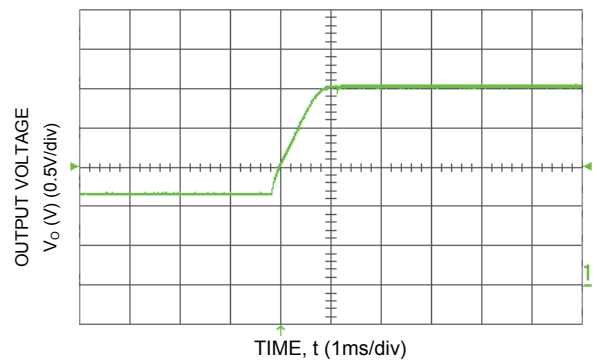

Figure 17. Typical Start-Up with Prebias ($V_{in} = 12\text{Vdc}$, $V_o = 2.5\text{Vdc}$, $I_o = 1\text{A}$, $V_{bias} = 1.2\text{Vdc}$).

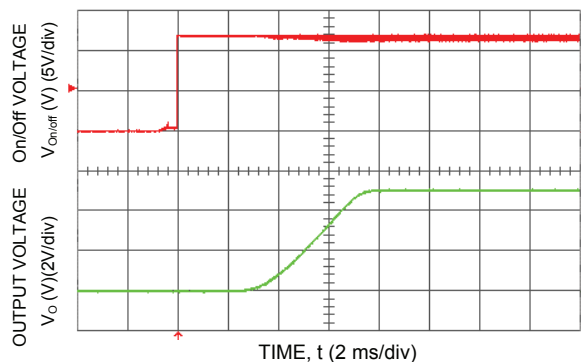

Figure 15. Typical Start-Up Using Remote On/Off with external capacitors ($V_{in} = 12\text{Vdc}$, $V_o = 5.0\text{Vdc}$, $I_o = 10\text{A}$, $C_o = 1050\ \mu\text{F}$).

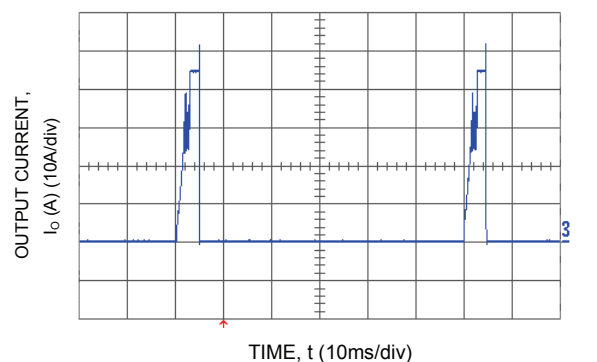

Figure 18. Output short circuit Current ($V_{in} = 12.0\text{Vdc}$, $V_o = 0.75\text{Vdc}$).

Characteristic Curves (continued)

The following figures provide thermal derating curves for the 12V Austin Lynx Programmable SIP modules.

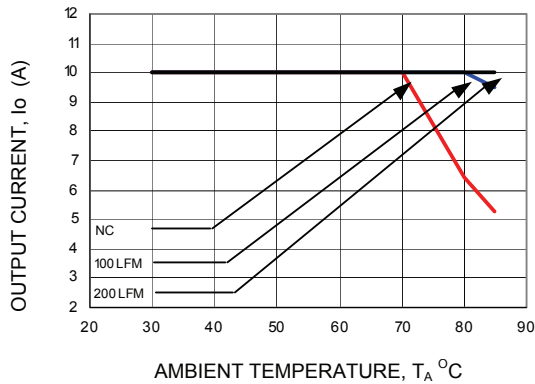

Figure 19. Derating Output Current versus Local Ambient Temperature and Airflow ($V_{in} = 12.0Vdc$, $V_o=0.75Vdc$).

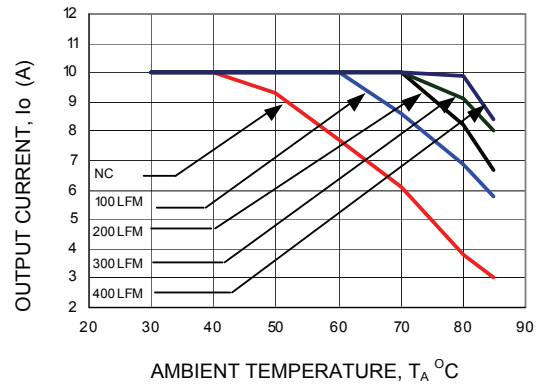

Figure 22. Derating Output Current versus Local Ambient Temperature and Airflow ($V_{in} = 12.0Vdc$, $V_o=5.0 Vdc$).

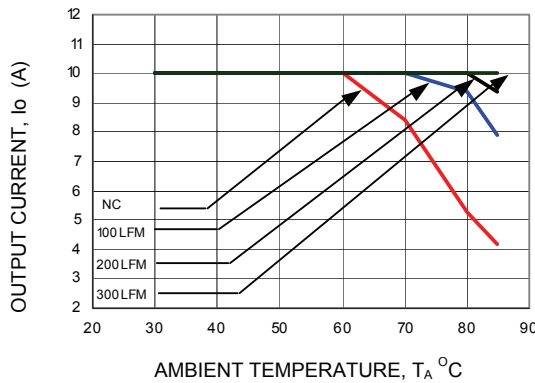

Figure 20. Derating Output Current versus Local Ambient Temperature and Airflow ($V_{in} = 12.0Vdc$, $V_o=1.8 Vdc$).

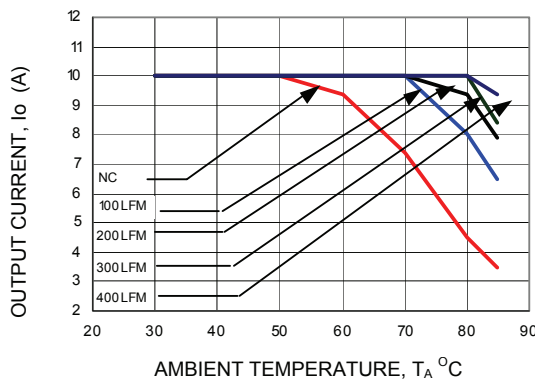
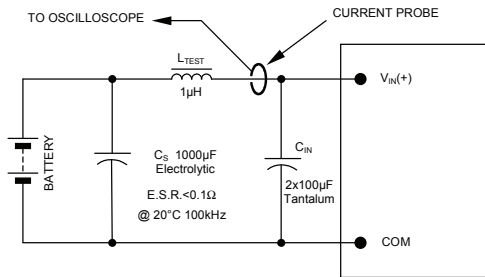

Figure 21. Derating Output Current versus Local Ambient Temperature and Airflow ($V_{in} = 12.0Vdc$, $V_o=3.3 Vdc$).

Test Configurations



NOTE: Measure input reflected ripple current with a simulated source inductance (L_{TEST}) of 1µH. Capacitor C_S offsets possible battery impedance. Measure current as shown above.

Figure 23. Input Reflected Ripple Current Test Setup.

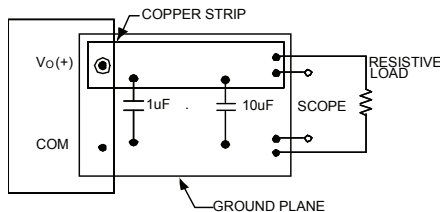

NOTE: All voltage measurements to be taken at the module terminals, as shown above. If sockets are used then Kelvin connections are required at the module terminals to avoid measurement errors due to socket contact resistance.

Figure 24. Output Ripple and Noise Test Setup.

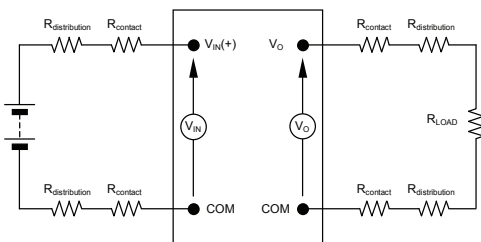

NOTE: All voltage measurements to be taken at the module terminals, as shown above. If sockets are used then Kelvin connections are required at the module terminals to avoid measurement errors due to socket contact resistance.

Figure 25. Output Voltage and Efficiency Test Setup.

$$\text{Efficiency } \eta = \frac{V_O \cdot I_O}{V_{IN} \cdot I_{IN}} \times 100 \%$$

Design Considerations

Input Filtering

The 12V Austin Lynx Programmable SIP module should be connected to a low ac-impedance source. A highly inductive source can affect the stability of the module. An input capacitance must be placed directly adjacent to the input pin of the module, to minimize input ripple voltage and ensure module stability.

In a typical application, 4x47 µF low-ESR tantalum capacitors (AVX part #: TPSE476M025R0100, 47µF 25V 100 mΩ ESR tantalum capacitor) will be sufficient to provide adequate ripple voltage at the input of the module. To minimize the ripple voltage at the input, very low ESR ceramic capacitors are recommended at the input of the module. Figure 26 shows input ripple voltage (mVp-p) for various outputs with 4x47 µF tantalum capacitors and with 4x 22 µF ceramic capacitor (TDK part #: C4532X5R1C226M) at full load.

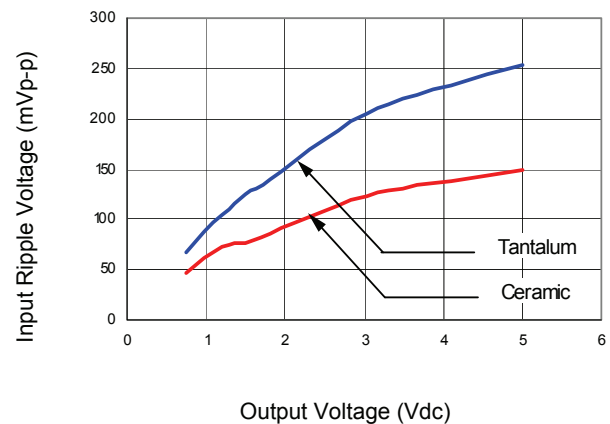

Figure 26. Input ripple voltage for various output with 4x47 µF polymer and 4x22 µF ceramic capacitors at the input (full load).

Design Considerations (continued)

Output Filtering

The 12V Austin Lynx Programmable SIP module is designed for low output ripple voltage and will meet the maximum output ripple specification with 1 μ F ceramic and 10 μ F tantalum capacitors at the output of the module. However, additional output filtering may be required by the system designer for a number of reasons. First, there may be a need to further reduce the output ripple and noise of the module. Second, the dynamic response characteristics may need to be customized to a particular load step change.

To reduce the output ripple and improve the dynamic response to a step load change, additional capacitance at the output can be used. Low ESR polymer and ceramic capacitors are recommended to improve the dynamic response of the module. For stable operation of the module, limit the capacitance to less than the maximum output capacitance as specified in the electrical specification table.

Safety Considerations

For safety agency approval the power module must be installed in compliance with the spacing and separation requirements of the end-use safety agency standards, i.e., UL 60950-1, CSA C22.2 No. 60950-1-03, and VDE 0850:2001-12 (EN60950-1) Licensed.

For the converter output to be considered meeting the requirements of safety extra-low voltage (SELV), the input must meet SELV requirements. The power module has extra-low voltage (ELV) outputs when all inputs are ELV.

The input to these units is to be provided with a fast-acting fuse with a maximum rating of 15A in the positive input lead.

Feature Description

Remote On/Off

The 12V Austin Lynx Programmable SIP power modules feature an On/Off pin for remote On/Off operation. If not using the remote On/Off pin, leave the pin open (module will be On). The On/Off pin signal ($V_{ON/OFF}$) is referenced to ground. To switch the module on and off using remote On/Off, connect an open collector npn transistor between the On/Off pin and the ground pin (See Figure 27).

During a logic-high (On/Off pin is pulled high internal to the module) when the transistor is in the Off state, the power module is ON. The maximum allowable leakage current of the transistor when $V_{ON/OFF} = V_{IN,max}$ is $10\mu A$. During a logic-low when the transistor is turned-on, the power module is OFF. During this state $V_{ON/OFF}$ is less than 0.3V and the maximum $I_{ON/OFF} = 1mA$.

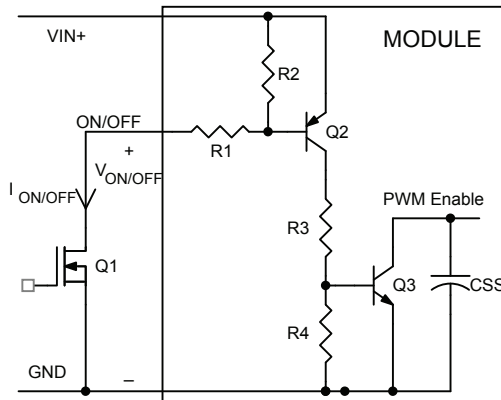

Figure 27. Circuit configuration for using positive logic On/OFF.

Overcurrent Protection

To provide protection in a fault (output overload) condition, the unit is equipped with internal current-limiting circuitry and can endure current limiting continuously. At the point of current-limit inception, the unit enters hiccup mode. The unit operates normally once the output current is brought back into its specified range. The typical average output current during hiccup is 3A.

Input Undervoltage Lockout

At input voltages below the input undervoltage lockout limit, module operation is disabled. The module will begin to operate at an input voltage above the undervoltage lockout turn-on threshold.

Overtemperature Protection

To provide protection in a fault condition, the unit is equipped with a thermal shutdown circuit. The unit will shutdown if the thermal reference point T_{ref} , exceeds $125^{\circ}C$ (typical), but the thermal shutdown is not intended as a guarantee that the unit will survive temperatures beyond its rating. The module will automatically restarts after it cools down.

Feature Descriptions (continued)

Output Voltage Programming

The output voltage of the 12V Austin Lynx Programmable SIP module can be programmed to any voltage from 0.75 Vdc to 5.5 Vdc by connecting a single resistor (shown as R_{trim} in Figure 28) between the TRIM and GND pins of the module. Without an external resistor between the TRIM pin and the ground, the output voltage of the module is 0.7525 Vdc. To calculate the value of the resistor R_{trim} for a particular output voltage V_o , use the following equation:

$$R_{trim} = \left[\frac{10500}{V_o - 0.7525} - 1000 \right] \Omega$$

For example, to program the output voltage of the 12V Austin Lynx Programmable SIP module to 1.8 Vdc, R_{trim} is calculated as follows:

$$R_{trim} = \left[\frac{10500}{1.8 - 0.7525} - 1000 \right]$$

$$R_{trim} = 9.024k\Omega$$

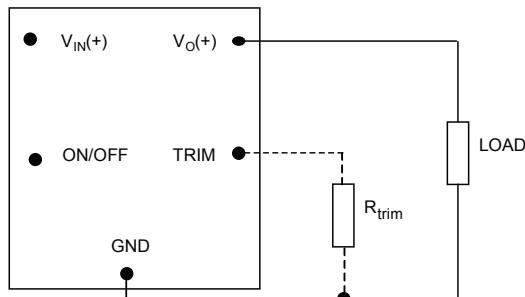

Figure 28. Circuit configuration for programming output voltage using an external resistor.

Table 1 provides R_{trim} values for some common output voltages, while Table 2 provides values of the external voltage source, V_{trim} for the same common output voltages.

Table 1

$V_{o, set}$ (V)	R_{trim} (K Ω)
0.7525	Open
1.2	22.46
1.5	13.05
1.8	9.024
2.5	5.009
3.3	3.122
5.0	1.472

By using a 1% tolerance trim resistor, set point tolerance of $\pm 2\%$ is achieved as specified in the electrical specification. The POL Programming Tool, available at www.lineagepower.com under the Design Tools section, helps determine the required external trim resistor needed for a specific output voltage.

The amount of power delivered by the module is defined as the voltage at the output terminals multiplied by the output current. When using the trim feature, the output voltage of the module can be increased, which at the same output current would increase the power output of the module. Care should be taken to ensure that the maximum output power of the module remains at or below the maximum rated power ($P_{max} = V_{o, set} \times I_{o, max}$).

Voltage Margining

Output voltage margining can be implemented in the 12V Austin Lynx Programmable SIP modules by connecting a resistor, $R_{margin-up}$, from the Trim pin to the ground pin for margining-up the output voltage and by connecting a resistor, $R_{margin-down}$, from the Trim pin to the Output pin for margining-down. Figure 29 shows the circuit configuration for output voltage margining. The POL Programming Tool, available at www.lineagepower.com under the Design Tools section, also calculates the values of $R_{margin-up}$ and $R_{margin-down}$ for a specific output voltage and % margin. Please consult your local Lineage Power technical representative for additional details.

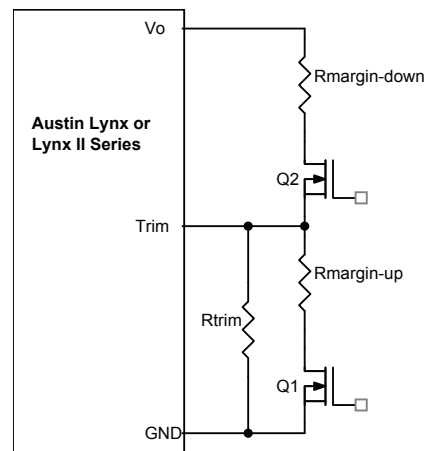

Figure 29. Circuit Configuration for margining Output voltage.

Remote Sense

The 12V Austin Lynx Programmable SIP power modules have a Remote Sense feature to minimize the effects of distribution losses by regulating the voltage at the Remote Sense pin (See Figure 30). The voltage

between the Sense pin and Vo pin must not exceed 0.5V.

The amount of power delivered by the module is defined as the output voltage multiplied by the output current ($V_o \times I_o$). When using Remote Sense, the output voltage of the module can increase, which if the same output is maintained, increases the power output by the module. Make sure that the maximum output power of the module remains at or below the maximum rated power. When the Remote Sense feature is not being used, leave the Remote Sense pin unconnected.

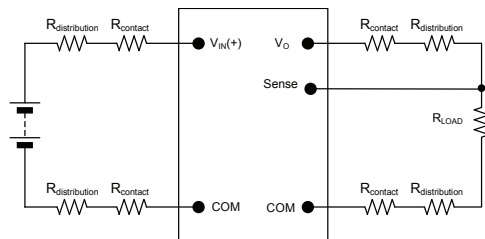

Figure 30. Remote sense circuit configuration

Thermal Considerations

The power modules operate in a variety of thermal environments; however, sufficient cooling should always be provided to help ensure reliable operation.

Considerations include ambient temperature, airflow, module power dissipation, and the need for increased reliability. A reduction in the operating temperature of the module will result in an increase in reliability. The thermal data presented here is based on physical measurements taken in a wind tunnel. The test set-up is shown in Figure 32. Note that the airflow is parallel to the long axis of the module as shown in figure 31. The derating data applies to airflow in either direction of the module's long axis.

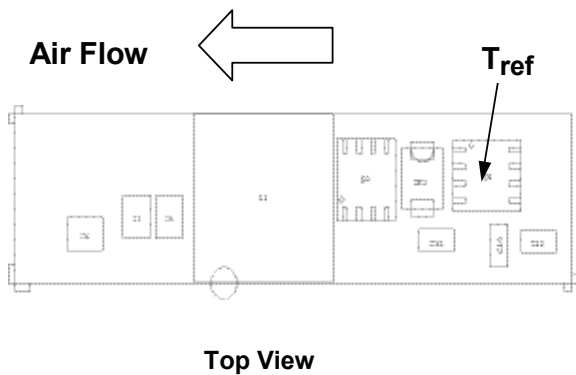

Figure 31. T_{ref} Temperature measurement location.

The thermal reference point, T_{ref} used in the specifications is shown in Figure 31. For reliable operation this temperature should not exceed 115 °C.

The output power of the module should not exceed the rated power of the module ($V_{o,set} \times I_{o,max}$).

Please refer to the Application Note “Thermal Characterization Process For Open-Frame Board-Mounted Power Modules” for a detailed discussion of thermal aspects including maximum device temperatures.

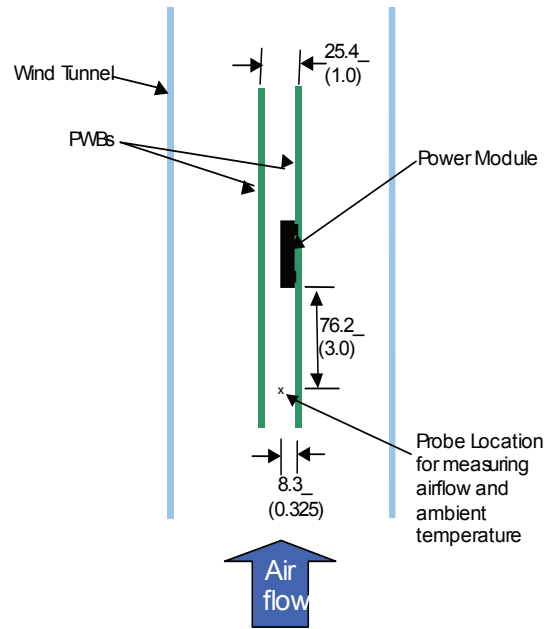

Figure 33. Thermal Test Set-up.

Heat Transfer via Convection

Increased airflow over the module enhances the heat transfer via convection. Thermal derating curves showing the maximum output current that can be delivered at different local ambient temperature (T_A) for airflow conditions ranging from natural convection and up to 2m/s (400 ft./min) are shown in the Characteristics Curves section.

Post solder Cleaning and Drying Considerations

Post solder cleaning is usually the final circuit-board assembly process prior to electrical board testing. The result of inadequate cleaning and drying can affect both the reliability of a power module and the testability of the finished circuit-board assembly. For guidance on appropriate soldering, cleaning and drying procedures, refer to *Board Mounted Power Modules: Soldering and Cleaning* Application Note.

Through-Hole Lead-Free Soldering Information

The RoHS-compliant through-hole products use the SAC (Sn/Ag/Cu) Pb-free solder and RoHS-compliant components. They are designed to be processed through single or dual wave soldering machines. The pins have an RoHS-compliant finish that is compatible with both Pb and Pb-free wave soldering processes. A maximum preheat rate of 3°C/s is suggested. The wave preheat process should be such that the temperature of the power module board is kept below 210°C. For Pb solder, the recommended pot temperature is 260°C, while the Pb-free solder pot is 270°C max. Not all RoHS-compliant through-hole products can be processed with paste-through-hole Pb or Pb-free reflow process. If additional information is needed, please consult with your Lineage Power technical representative for more details.

Mechanical Outline

Dimensions are in millimeters and (inches).

Tolerances: x.x mm ± 0.5 mm (x.xx in. ± 0.02 in.) [unless otherwise indicated]

x.xx mm ± 0.25 mm (x.xxx in ± 0.010 in.)

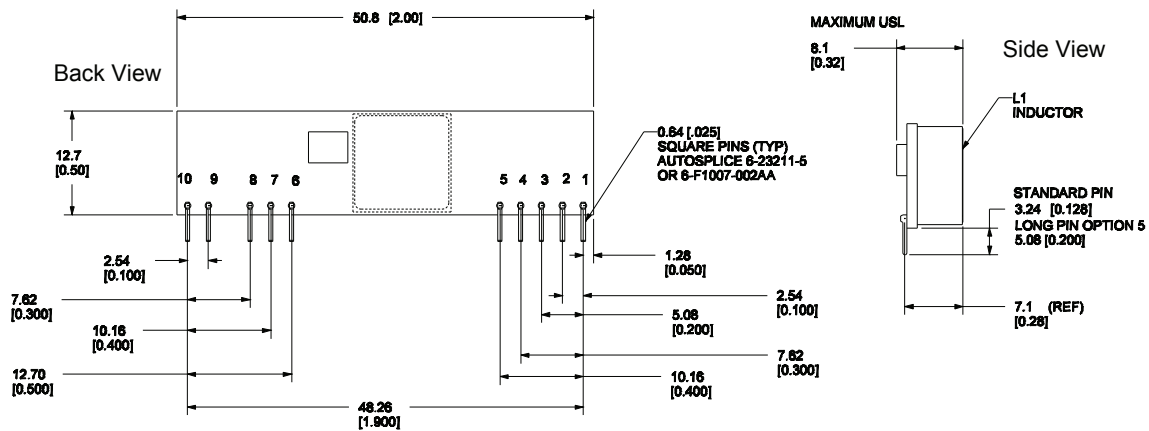

Pin	Function
1	V _o
2	V _o
3	V _{o,sense}
4	V _o
5	GND
6	GND
7	V _{IN}
8	V _{IN}
9	TRIM
10	ON/OFF

* Remote sense feature is a customer specified option (code suffix "3")

Recommended Pad Layout

Dimensions are in millimeters and (inches).

Tolerances: x.x mm ± 0.5 mm (x.xx in. ± 0.02 in.) [unless otherwise indicated]

x.xx mm ± 0.25 mm (x.xxx in ± 0.010 in.)

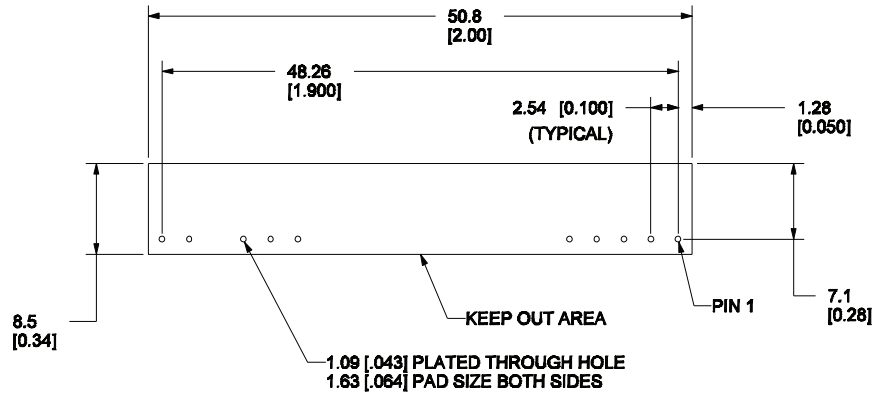

RECOMMENDED HOLE PATTERN
COMPONENT-SIDE FOOTPRINT

Pin	Function
1	V _o
2	V _o
3	V _{o,sense}
4	V _o
5	GND
6	GND
7	V _{IN}
8	V _{IN}
9	TRIM
10	ON/OFF

Ordering Information

Please contact your Lineage Power Sales Representative for pricing, availability and optional features.

Table 2. Device Codes

Device Code	Input Voltage Range	Output Voltage	Output Current	Efficiency 3.3V @full load	Connector Type	Comcodes
AXA010A0X3	10 – 14Vdc	0.75 – 5.5Vdc	10 A	93.0%	TH	108970120
AXA010A0X3Z	10 – 14Vdc	0.75 – 5.5Vdc	10 A	93.0%	TH	CC109101318

* Remote sense feature is active and pin 6 is added with code suffix “3”

-Z refers to RoHS compliant Versions

Table 3. Device Option

Option*	Suffix**
Long Pins 5.08 mm ± 0.25mm (0.200 in. ± 0.010 in.)	5

* Contact Lineage Power Sales Representative for availability of these options, samples, minimum order quantity and lead times

** When adding multiple options to the product code, add suffix numbers in the descending order



LINEAGE POWER

World Wide Headquarters
Lineage Power Corporation
 601 Shiloh Road, Plano, TX 75074, USA
+1-800-526-7819
 (Outside U.S.A.: **+1-972-244-9428**)
www.lineagepower.com
e-mail: techsupport1@lineagepower.com

Asia-Pacific Headquarters
 Tel: +65 6593 7211

Europe, Middle-East and Africa Headquarters
 Tel: +49 898 780 672 80

India Headquarters
 Tel: +91 80 28411633

Lineage Power reserves the right to make changes to the product(s) or information contained herein without notice. No liability is assumed as a result of their use or application. No rights under any patent accompany the sale of any such product(s) or information.

Lineage Power DC-DC products are protected under various patents. Information on these patents is available at www.lineagepower.com/patents.

© 2009 Lineage Power Corporation, (Plano, Texas) All International Rights Reserved.