

Specification

SSC-STW8T16C

SSC-STW8T16C

June 2012

www.seoulsemicon.com

STW8T16C

Description

This surface-mount LED comes in standard package dimension. It has a substrate made up of a molded plastic reflector sitting on top of a lead frame. The die is attached within the reflector cavity and the cavity is encapsulated by silicone.

The package design coupled with careful selection of component materials allow these products to perform with high reliability.



STW8T16C

Features

- Lead Frame type LED PKG size: 5.0*5.0 thickness 1.0mm
- White colored SMT package
- Pb-free Reflow Soldering Application
- RoHS compliant

Applications

- Interior lighting
- General lighting
- Indoor and out door displays
- Architectural / Decorative lighting

SSC-STW8T16C

June 2012

www.seoulsemicon.com

[Contents]

- 1. Full code of STW8T16C**
- 2. Outline dimensions of STW8T16C**
- 3. Characteristics of STW8T16C**
- 4. Characteristic diagrams**
- 5. Color & Binning**
- 6. Bin Code Description**
- 7. Labeling**
- 8. Packing**
- 9. Recommended solder pad**
- 10. Soldering**
- 11. Precaution for use**
- 12. Handling of Silicone Resin LEDs**
- 13. Revision history**

1. Full code of STW8T16C

Full code form : $X_1 X_2 - X_3 X_4 - X_5 - X_6 X_7 - X_8$

1. Part Number

- X_1 : Company
- X_2 : Kind of LED

2. Internal Number

- $X_3 X_4$: CRI Group
- X_5 : Package series
- $X_6 X_7$: Characteristic code
- X_8 : Version

2. Outline dimensions of STW8T16C

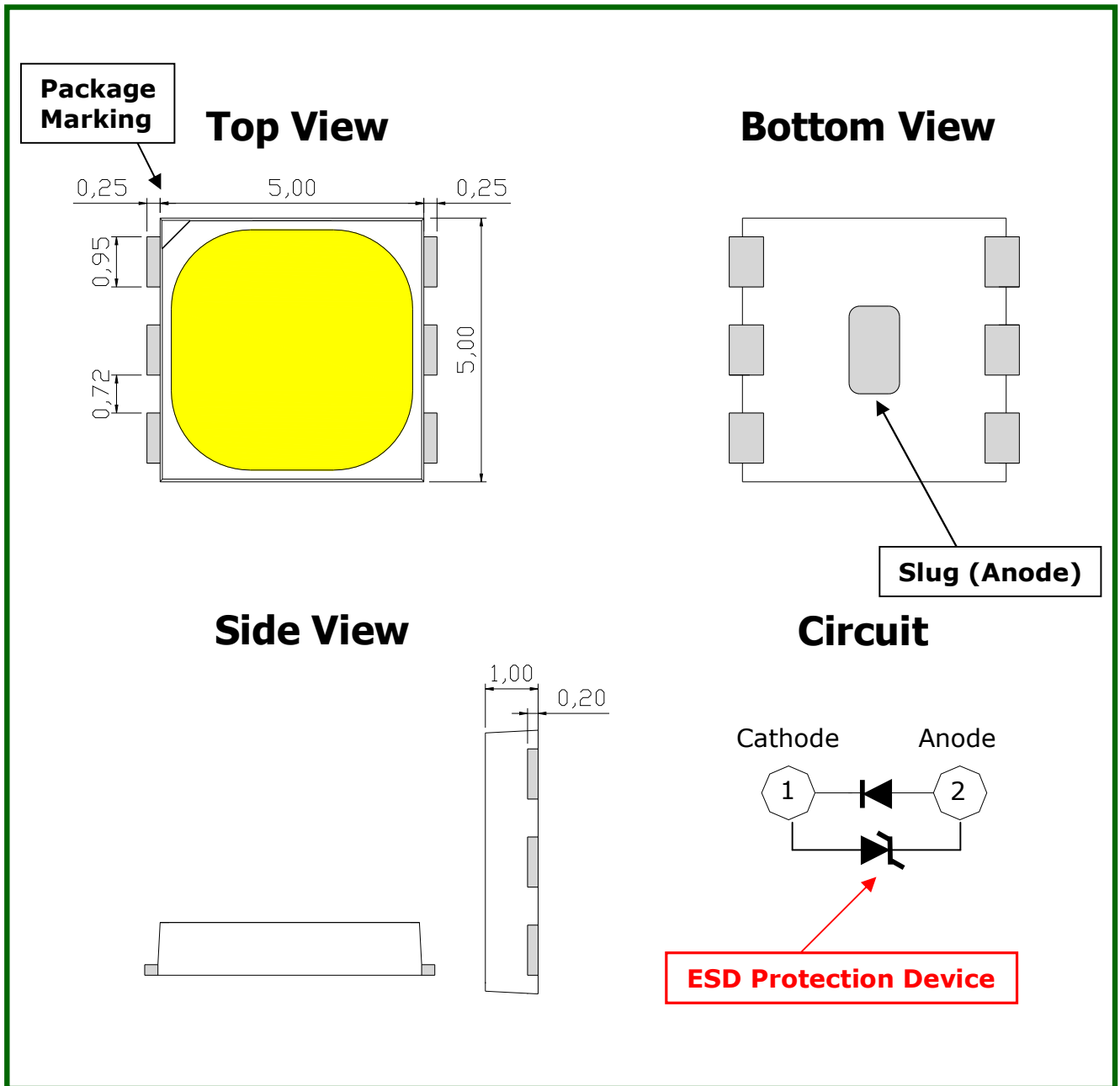

Notes :

- [1] All dimensions are in millimeters.
- [2] Scale : none
- [3] Undefined tolerance is $\pm 0.1\text{mm}$

SSC-STW8T16C

June 2012

www.seoulsemicon.com

3. Characteristics of STW8T16C

1) Electro-Optical characteristics at 65mA

(Ta=25°C, RH30%)

Parameter	Symbol	Value			Unit
		Min	Typ	Max	
Forward Voltage	V_F	2.8	-	3.3	V
Reverse Voltage	V_R	-	0.9	1.2	V
Luminous Intensity*^[1] (3,700~8,200 K)	I_V	-	9.0 (27.5)	-	cd (lm)
Luminous Intensity*^[1] (2,600~3,700 K)	I_V	-	8.2 (24.6)	-	cd (lm)
Correlated Color Temperature	CCT	2,600	-	8,200	K
Viewing Angle ^[2]	$2\theta_{1/2}$	-	120	-	-
Color Rendering Index*	Ra	80	-	90	-
Thermal resistance (J to S)	$R\theta_{J-S}$	-	14	-	K/W

2) Absolute Maximum Ratings

Parameter	Symbol	Value	Unit
Forward Current	I_F	100	mA
Power Dissipation*^[3]	P_d	315	mW
Junction Temperature	T_j	125	°C
Operating Temperature	T_{opr}	-40 ~ +85	°C
Storage Temperature	T_{stg}	-40 ~ +100	°C
ESD (HBM)		±5,000V HBM	V

Notes :

All measurements were made under the standardized environment of SSC.

LED's properties might be different from suggested values like above and below tables if operation condition will be exceeded our parameter range.

[1] The luminous intensity I_V was measured at the peak of the spatial pattern which may not be aligned with the mechanical axis of the LED package.

[2] $2\theta_{1/2}$ is the off-axis where the luminous intensity is 1/2 of the peak intensity.

[3] Care is to be taken that power dissipation does not exceed the absolute maximum rating of the product.

* Tolerance : V_F : ±0.1V, I_V : ±7%, Ra : ±2, x,y : ±0.007

SSC-STW8T16C

June 2012

www.seoulsemicon.com

4. Characteristic diagrams

1) Spectrum data

(IF=65mA, Ta=25°C, RH30%)

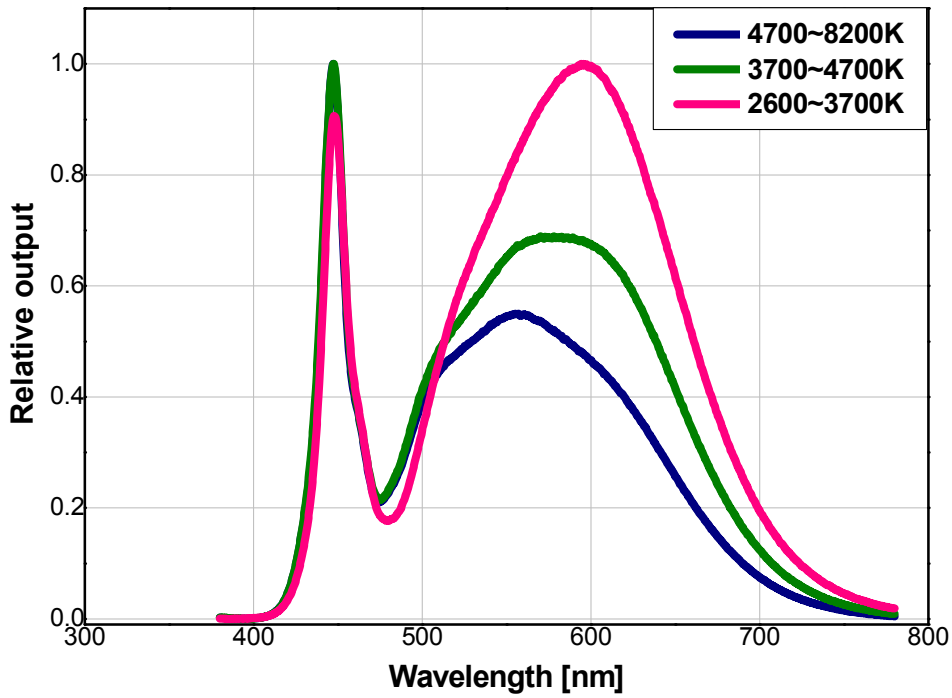

2) Forward Voltage vs. Forward Current, Ta=25°C

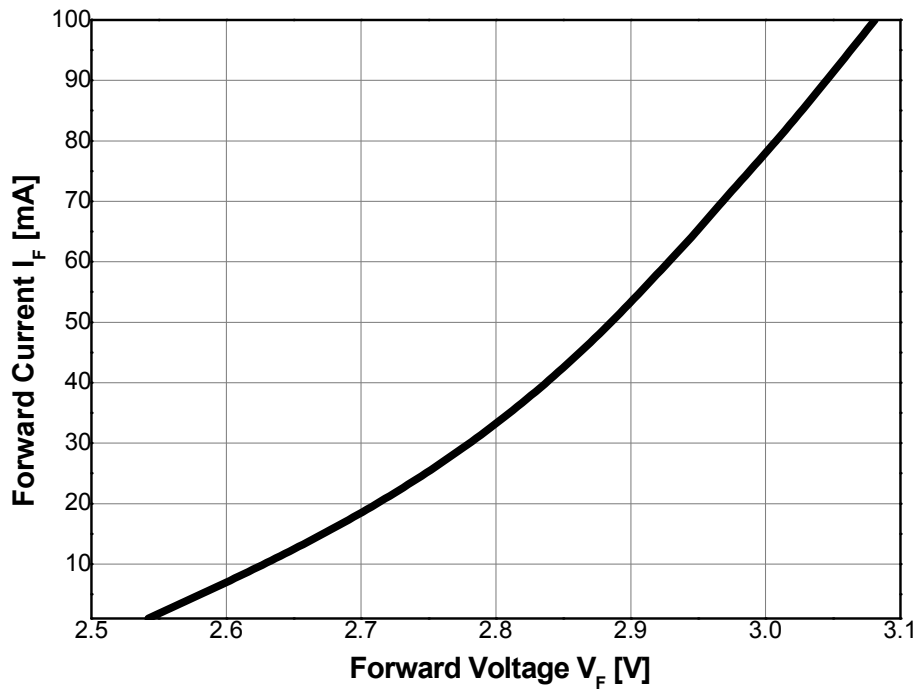

3) Forward Current vs. Relative Luminous Intensity, Ta=25°C

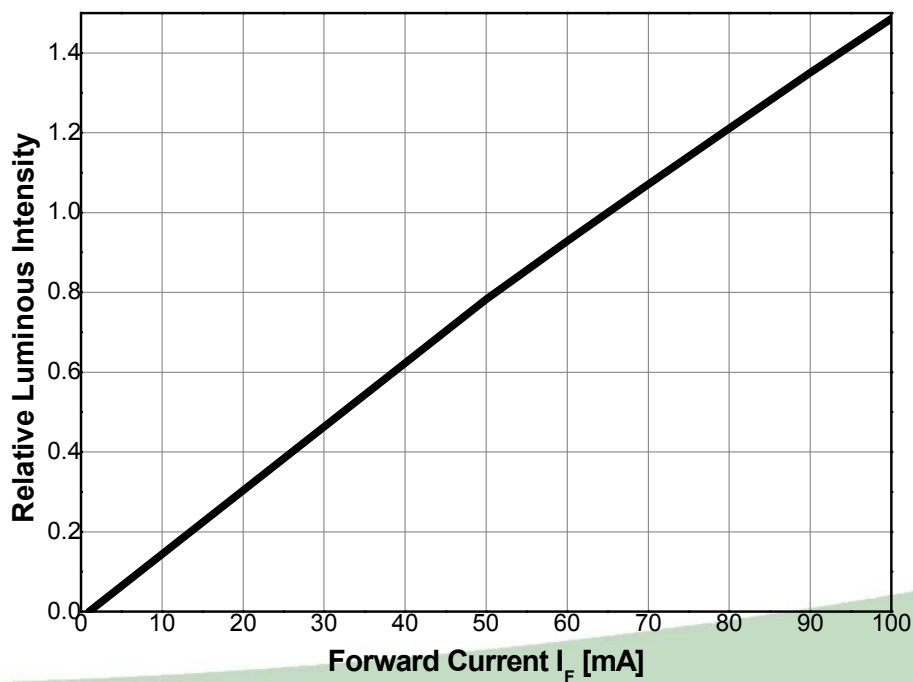

SSC-STW8T16C

June 2012

www.seoulsemicon.com

4) Chromaticity Coordinate vs. Forward Current, Ta=25°C

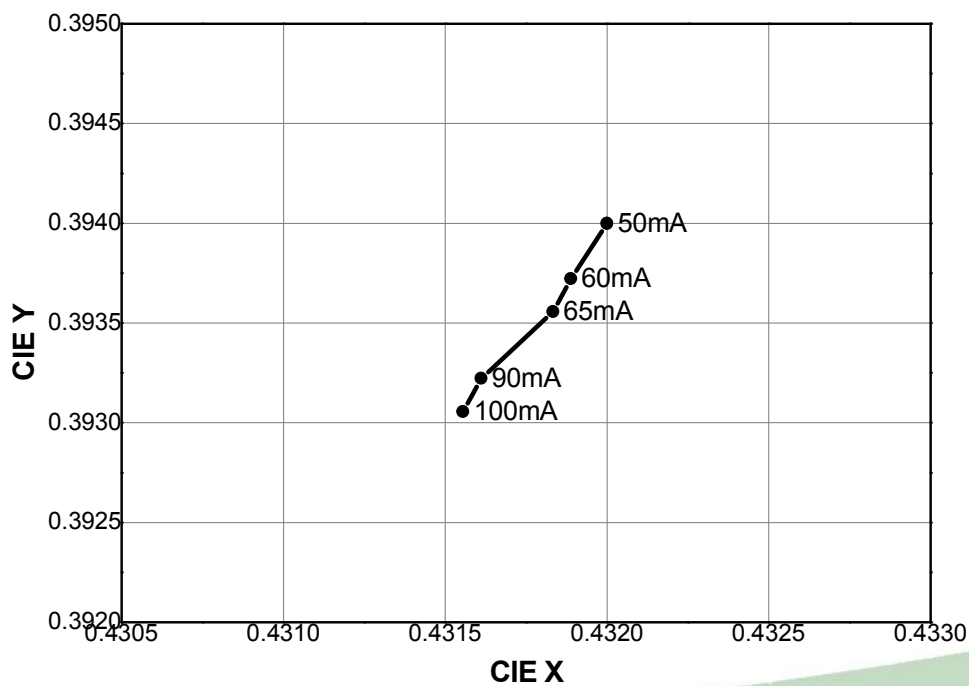
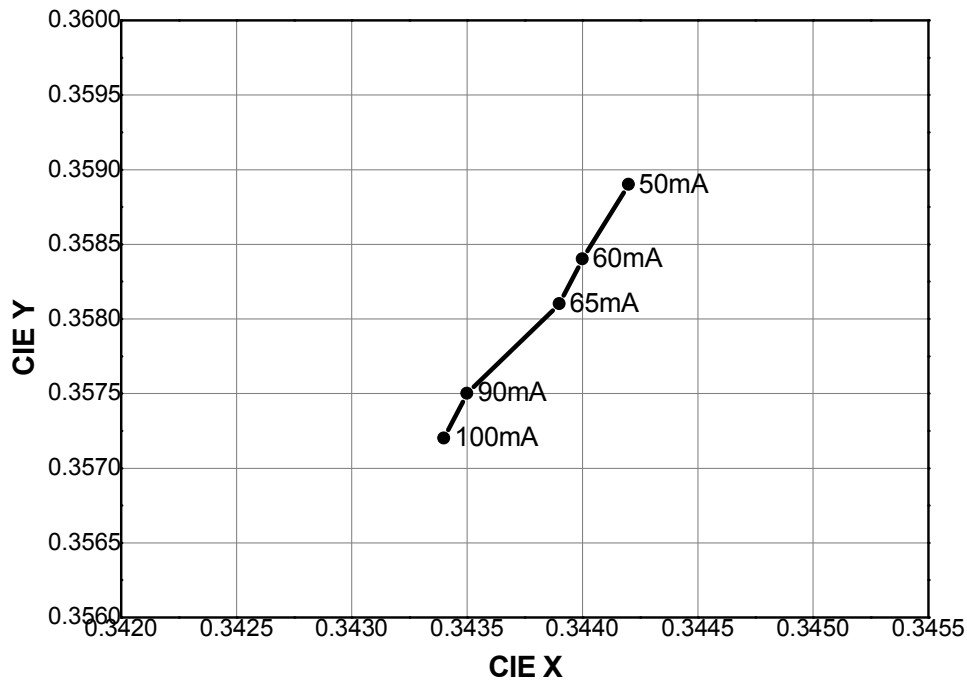

5) Relative Luminous Intensity vs. Junction Temperature, IF=65mA

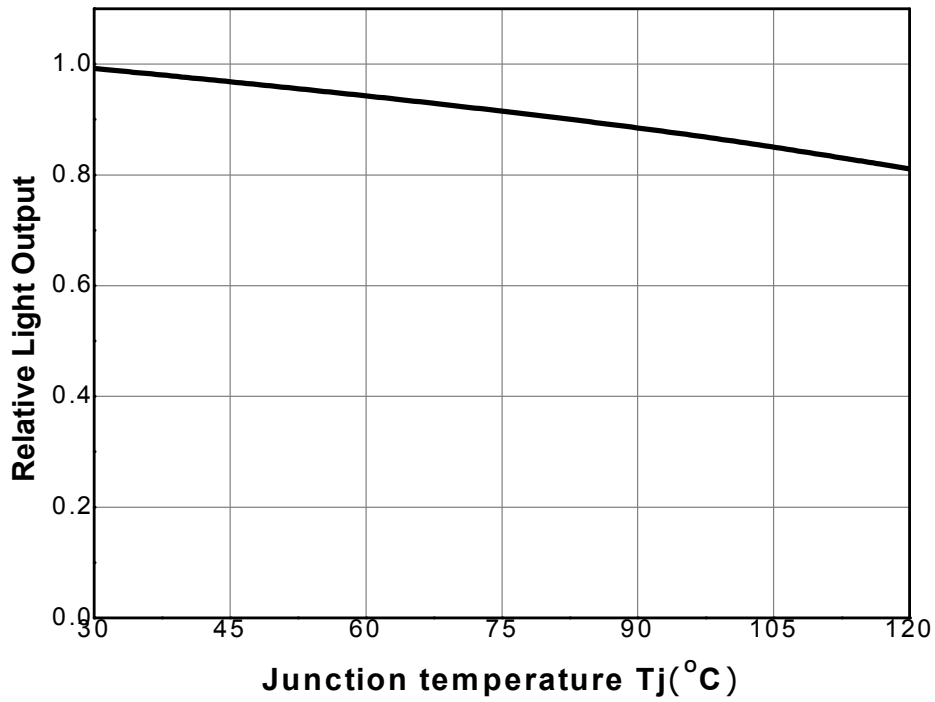

6) Chromaticity Coordinate vs. Junction Temperature, IF=65mA

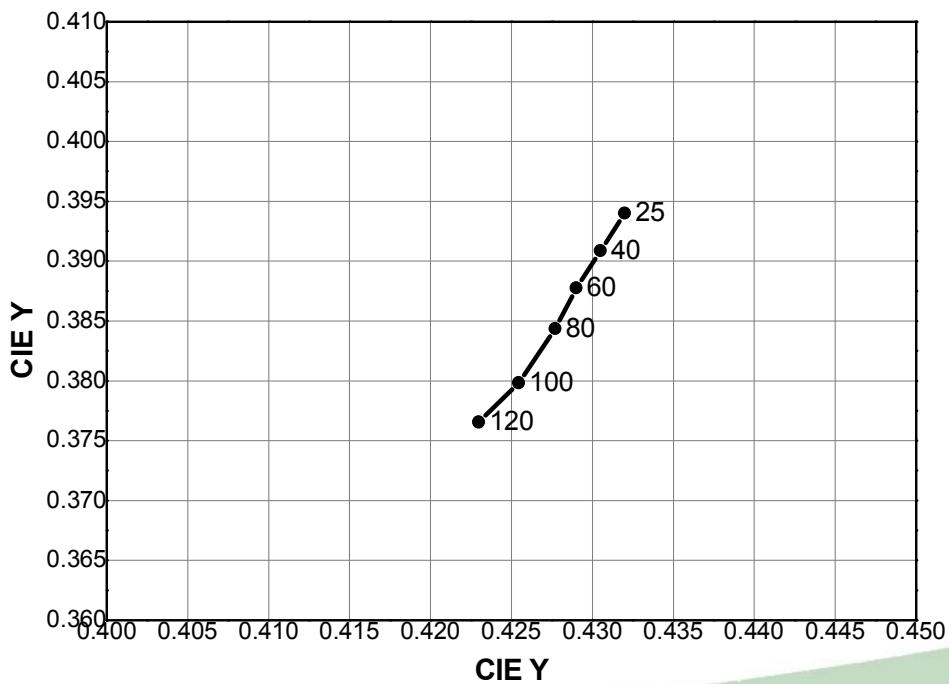
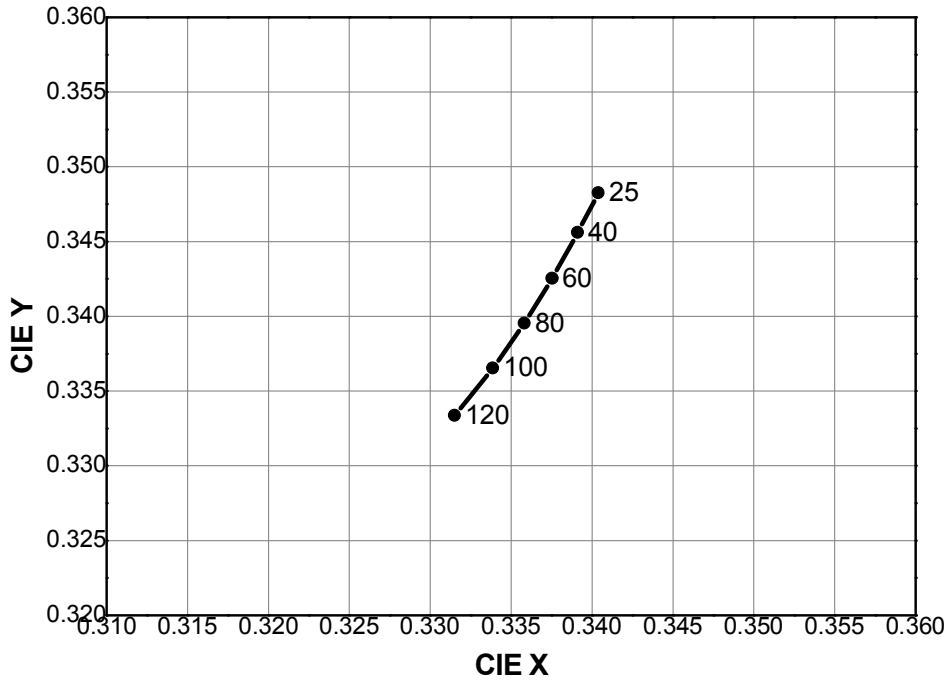

7) Ambient Temperature vs. Allowable Forward Current, $I_F=65\text{mA}$

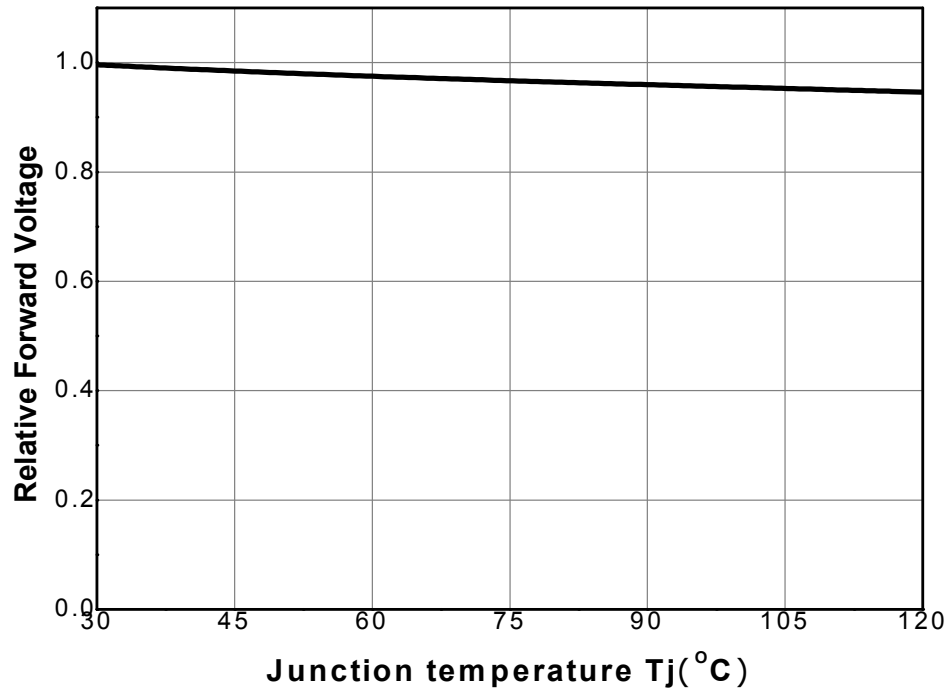

8) Ambient Temperature vs. Maximum Forward Current

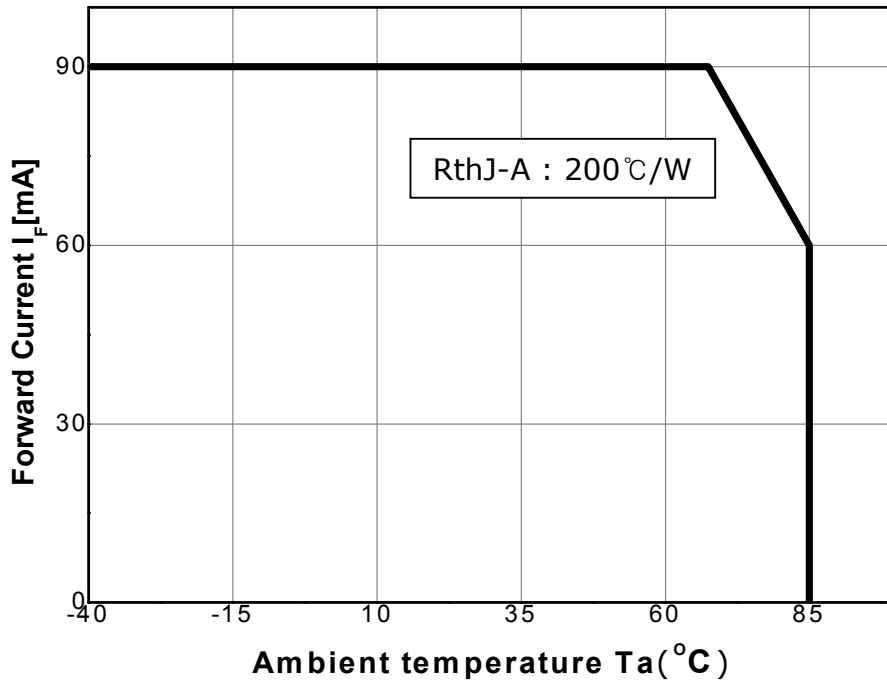

9) Viewing angle, Ta=25°C

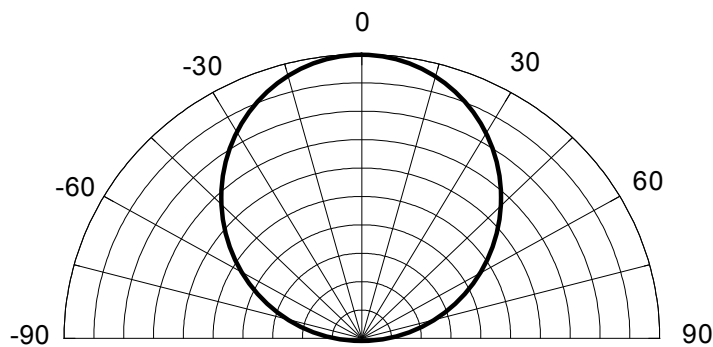

5. Color & Binning

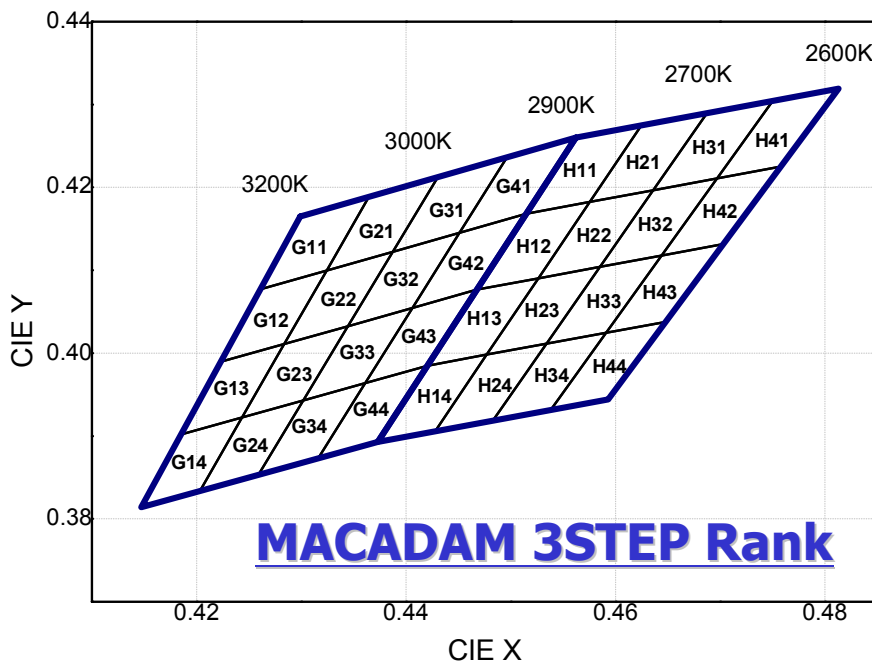
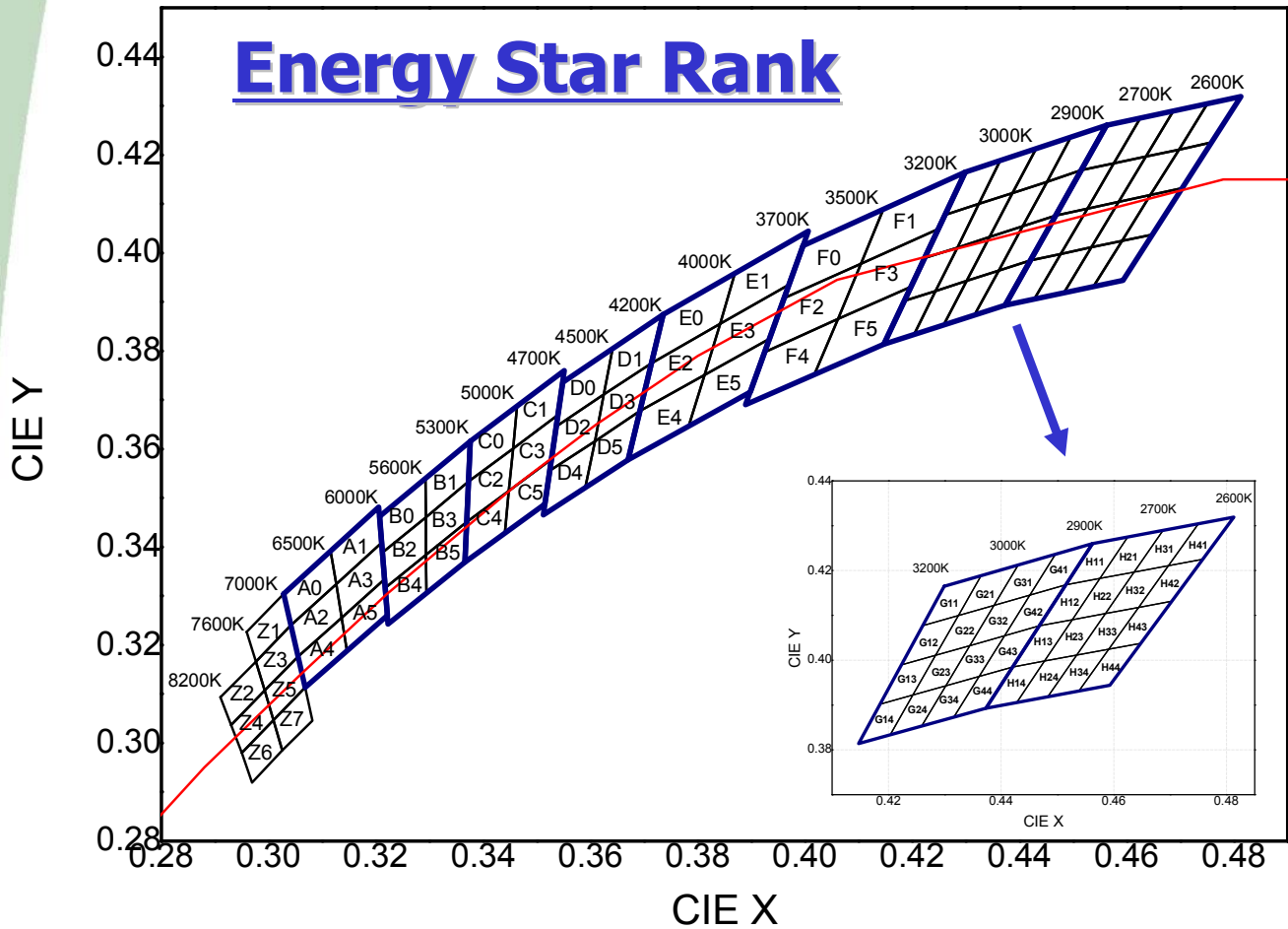

* Apply the Energy Star binning(3200~7000K) & MACADAM 3 Step binning (just, 2600~3200K)

* Measurement Uncertainty of the Color Coordinates : ± 0.007

SSC-STW8T16C

June 2012

www.seoulsemicon.com

5. Color & Binning

● COLOR RANK

<IF=65mA, Ta=25℃>

Z1		Z2		Z3	
CIE X	CIE Y	CIE X	CIE Y	CIE X	CIE Y
0.2959	0.3227	0.291	0.3093	0.2976	0.3166
0.2976	0.3166	0.293	0.3037	0.2993	0.3107
0.3041	0.324	0.2993	0.3107	0.3055	0.3177
0.3028	0.3304	0.2976	0.3166	0.3041	0.324
Z4		Z5		Z6	
CIE X	CIE Y	CIE X	CIE Y	CIE X	CIE Y
0.293	0.3037	0.2993	0.3107	0.295	0.298
0.295	0.298	0.3009	0.3047	0.2969	0.2919
0.3009	0.3047	0.3068	0.3113	0.3025	0.2985
0.2993	0.3107	0.3055	0.3177	0.3009	0.3047
Z7					
CIE X	CIE Y				
0.3009	0.3047				
0.3025	0.2985				
0.3082	0.3046				
0.3068	0.3113				

5. Color & Binning

● COLOR RANK

<IF=65mA, Ta=25℃>

A0		A1		A2	
CIE X	CIE Y	CIE X	CIE Y	CIE X	CIE Y
0.3028	0.3304	0.3115	0.3393	0.3041	0.324
0.3041	0.324	0.3126	0.3324	0.3055	0.3177
0.3126	0.3324	0.321	0.3408	0.3136	0.3256
0.3115	0.3393	0.3205	0.3481	0.3126	0.3324
A3		A4		A5	
CIE X	CIE Y	CIE X	CIE Y	CIE X	CIE Y
0.3126	0.3324	0.3055	0.3177	0.3136	0.3256
0.3136	0.3256	0.3068	0.3113	0.3146	0.3187
0.3216	0.3334	0.3146	0.3187	0.3221	0.3261
0.321	0.3408	0.3136	0.3256	0.3216	0.3334
B0		B1		B2	
CIE X	CIE Y	CIE X	CIE Y	CIE X	CIE Y
0.3207	0.3462	0.3292	0.3539	0.3212	0.3389
0.3212	0.3389	0.3293	0.3461	0.3217	0.3316
0.3293	0.3461	0.3373	0.3534	0.3293	0.3384
0.3292	0.3539	0.3376	0.3616	0.3293	0.3461
B3		B4		B5	
CIE X	CIE Y	CIE X	CIE Y	CIE X	CIE Y
0.3293	0.3461	0.3217	0.3316	0.3293	0.3384
0.3293	0.3384	0.3222	0.3243	0.3294	0.3306
0.3369	0.3451	0.3294	0.3306	0.3366	0.3369
0.3373	0.3534	0.3293	0.3384	0.3369	0.3451

5. Color & Binning

● COLOR RANK

<IF=65mA, Ta=25℃>

C0		C1		C2	
CIE X	CIE Y	CIE X	CIE Y	CIE X	CIE Y
0.3376	0.3616	0.3463	0.3687	0.3373	0.3534
0.3373	0.3534	0.3456	0.3601	0.3369	0.3451
0.3456	0.3601	0.3539	0.3669	0.3448	0.3514
0.3463	0.3687	0.3552	0.376	0.3456	0.3601
C3		C4		C5	
CIE X	CIE Y	CIE X	CIE Y	CIE X	CIE Y
0.3456	0.3601	0.3369	0.3451	0.3448	0.3514
0.3448	0.3514	0.3366	0.3369	0.344	0.3428
0.3526	0.3578	0.344	0.3428	0.3514	0.3487
0.3539	0.3669	0.3448	0.3514	0.3526	0.3578
D0		D1		D2	
CIE X	CIE Y	CIE X	CIE Y	CIE X	CIE Y
0.3548	0.3736	0.3641	0.3804	0.3536	0.3646
0.3536	0.3646	0.3625	0.3711	0.3523	0.3555
0.3625	0.3711	0.3714	0.3775	0.3608	0.3616
0.3641	0.3804	0.3736	0.3874	0.3625	0.3711
D3		D4		D5	
CIE X	CIE Y	CIE X	CIE Y	CIE X	CIE Y
0.3625	0.3711	0.3523	0.3555	0.3608	0.3616
0.3608	0.3616	0.3511	0.3465	0.359	0.3521
0.3692	0.3677	0.359	0.3521	0.367	0.3578
0.3714	0.3775	0.3608	0.3616	0.3692	0.3677

5. Color & Binning

● COLOR RANK

<IF=65mA, Ta=25℃>

E0		E1		E2	
CIE X	CIE Y	CIE X	CIE Y	CIE X	CIE Y
0.3736	0.3874	0.3869	0.3958	0.3714	0.3775
0.3714	0.3775	0.3842	0.3855	0.3692	0.3677
0.3842	0.3855	0.397	0.3935	0.3813	0.3751
0.3869	0.3958	0.4006	0.4044	0.3842	0.3855
E3		E4		E5	
CIE X	CIE Y	CIE X	CIE Y	CIE X	CIE Y
0.3842	0.3855	0.3692	0.3677	0.3813	0.3751
0.3813	0.3751	0.367	0.3578	0.3783	0.3646
0.3934	0.3825	0.3783	0.3646	0.3898	0.3716
0.397	0.3935	0.3813	0.3751	0.3934	0.3825
F0		F1		F2	
CIE X	CIE Y	CIE X	CIE Y	CIE X	CIE Y
0.3996	0.4015	0.4146	0.4089	0.396	0.3907
0.396	0.3907	0.4104	0.3978	0.3925	0.3798
0.4104	0.3978	0.4248	0.4048	0.4062	0.3865
0.4146	0.4089	0.4299	0.4165	0.4104	0.3978
F3		F4		F5	
CIE X	CIE Y	CIE X	CIE Y	CIE X	CIE Y
0.4104	0.3978	0.3925	0.3798	0.4062	0.3865
0.4062	0.3865	0.3889	0.369	0.4017	0.3751
0.4198	0.3931	0.4017	0.3751	0.4147	0.3814
0.4248	0.4048	0.4062	0.3865	0.4198	0.3931

5. Color & Binning

● COLOR RANK

<IF=65mA, Ta=25℃>

G11		G21		G31		G41	
CIE X	CIE Y	CIE X	CIE Y	CIE X	CIE Y	CIE X	CIE Y
0.4365	0.4189	0.4430	0.4212	0.4496	0.4236	0.4562	0.4260
0.4324	0.4100	0.4387	0.4122	0.4451	0.4145	0.4515	0.4168
0.4261	0.4077	0.4324	0.4100	0.4387	0.4122	0.4451	0.4145
0.4299	0.4165	0.4365	0.4189	0.4430	0.4212	0.4496	0.4236
G12		G22		G32		G42	
CIE X	CIE Y	CIE X	CIE Y	CIE X	CIE Y	CIE X	CIE Y
0.4324	0.4100	0.4387	0.4122	0.4451	0.4145	0.4515	0.4168
0.4284	0.4011	0.4345	0.4033	0.4406	0.4055	0.4468	0.4077
0.4223	0.3990	0.4284	0.4011	0.4345	0.4033	0.4406	0.4055
0.4261	0.4077	0.4324	0.4100	0.4387	0.4122	0.4451	0.4145
G13		G23		G33		G43	
CIE X	CIE Y	CIE X	CIE Y	CIE X	CIE Y	CIE X	CIE Y
0.4284	0.4011	0.4345	0.4033	0.4406	0.4055	0.4468	0.4077
0.4243	0.3922	0.4302	0.3943	0.4361	0.3964	0.4420	0.3985
0.4185	0.3902	0.4243	0.3922	0.4302	0.3943	0.4361	0.3964
0.4223	0.3990	0.4284	0.4011	0.4345	0.4033	0.4406	0.4055
G14		G24		G34		G44	
CIE X	CIE Y	CIE X	CIE Y	CIE X	CIE Y	CIE X	CIE Y
0.4243	0.3922	0.4302	0.3943	0.4361	0.3964	0.4316	0.3873
0.4203	0.3834	0.4259	0.3853	0.4259	0.3853	0.4302	0.3943
0.4147	0.3814	0.4203	0.3834	0.4420	0.3985	0.4373	0.3893
0.4185	0.3902	0.4243	0.3922	0.4316	0.3873	0.4361	0.3964

SSC-STW8T16C

June 2012

* Measurement Uncertainty of the Color Coordinates : ± 0.007

www.seoulsemicon.com

서식번호 : SSC-QP-7-07-12 (Rev.01)

5. Color & Binning

● COLOR RANK

<IF=65mA, Ta=25℃>

H11		H21		H31		H41	
CIE X	CIE Y	CIE X	CIE Y	CIE X	CIE Y	CIE X	CIE Y
0.4325	0.4275	0.4687	0.4289	0.4750	0.4304	0.4810	0.4319
0.4575	0.4182	0.4636	0.4197	0.4697	0.4211	0.4758	0.4225
0.4515	0.4168	0.4575	0.4182	0.4636	0.4197	0.4697	0.4211
0.4562	0.4260	0.4625	0.4275	0.4687	0.4289	0.4750	0.4304
H12		H22		H32		H42	
CIE X	CIE Y	CIE X	CIE Y	CIE X	CIE Y	CIE X	CIE Y
0.4575	0.4182	0.4636	0.4197	0.4697	0.4211	0.4758	0.4225
0.4526	0.4090	0.4585	0.4104	0.4644	0.4118	0.4703	0.4132
0.4468	0.4077	0.4526	0.4090	0.4585	0.4104	0.4644	0.4118
0.4515	0.4168	0.4575	0.4182	0.4636	0.4197	0.4697	0.4211
H13		H23		H33		H43	
CIE X	CIE Y	CIE X	CIE Y	CIE X	CIE Y	CIE X	CIE Y
0.4526	0.4090	0.4585	0.4104	0.4644	0.4118	0.4703	0.4132
0.4477	0.3998	0.4534	0.4012	0.4591	0.4025	0.4648	0.4038
0.4420	0.3985	0.4477	0.3998	0.4534	0.4012	0.4591	0.4025
0.4468	0.4077	0.4526	0.4090	0.4585	0.4104	0.4644	0.4118
H14		H24		H34		H44	
CIE X	CIE Y	CIE X	CIE Y	CIE X	CIE Y	CIE X	CIE Y
0.4477	0.3998	0.4534	0.4012	0.4591	0.4025	0.4648	0.4038
0.4428	0.3906	0.4483	0.3919	0.4538	0.3932	0.4593	0.3944
0.4373	0.3893	0.4428	0.3906	0.4483	0.3919	0.4538	0.3932
0.4420	0.3985	0.4477	0.3998	0.4534	0.4012	0.4591	0.4025

SSC-STW8T16C

June 2012

* Measurement Uncertainty of the Color Coordinates : ± 0.007

www.seoulsemicon.com

서식번호 : SSC-QP-7-07-12 (Rev.01)

6. Bin Code Description

Bin Code		
Luminous Intensity [mcd]	Color Rank	Forward Voltage [V]
R0	A1	Z1



2,600K ~ 8,200K

Luminous Intensity [mcd] *[1] @ $I_F = 65\text{mA}$			Flux *[2] [lm]
RANK	Min.	Max.	Typ.
Q0	7000	8000	23
R0	8000	9000	26.8
S0	9000	10000	29.5
T0	10000	11000	31.8

Color Rank @ $I_F = 65\text{mA}$
Z~H

Forward Voltage [V] @ $I_F = 65\text{mA}$		
RANK	Min.	Max.
Y2	2.8	2.9
Y3	2.9	3.0
Z1	3.0	3.1
Z2	3.1	3.2
Z3	3.2	3.3

Available ranks
 Not yet available ranks

CCT	CIE	IV Rank			
7000~8200K	Z	Q0	R0	S0	T0
6000~7000K	A	Q0	R0	S0	T0
5300~6000K	B	Q0	R0	S0	T0
4700~5300K	C	Q0	R0	S0	T0
4200~4700K	D	Q0	R0	S0	T0
3700~4200K	E	Q0	R0	S0	T0
3200~3700K	F	Q0	R0	S0	T0
2900~3200K	G	Q0	R0	S0	T0
2600~2900K	H	Q0	R0	S0	T0

***Notes :**

All measurements were made under the standardized environment of SSC.
In order to ensure availability, single color rank will not be orderable.

[1] SSC sort the LED package according to the luminous intensity IV.

[2] The lumen table is only for reference.

SSC-STW8T16C

June 2012

www.seoulsemicon.com

7. Labeling

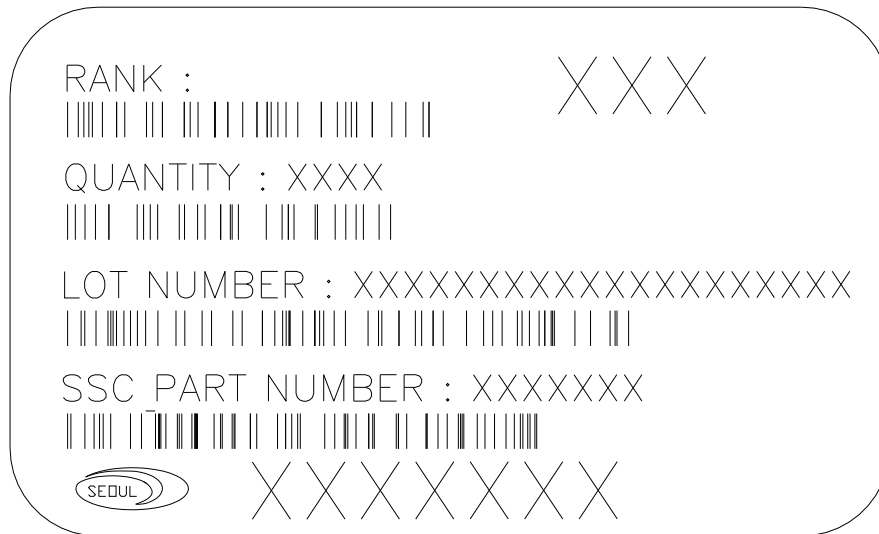

Full code form :

X₁X₂-X₃X₄-X₅-X₆X₇-X₈

- X₁ : Company
- X₂ : Kind of LED
- X₃X₄ : CRI Group
- X₅ : Package series
- X₆X₇ : Characteristic code
- X₈ : Version

Rank

1 # 2 # 3

- #1 : Luminous Intensity : IV
- #2 : Color coordinates : x, y
- #3 : Forward Voltage : V_F

8. Packing

Reel

RANK: XXXX
 QUANTITY : XXXX
 LOT NUMBER : XXXXXXXXXXXX
 PART NUMBER : XXXXXXXX
 SEOUL SEMICONDUCTOR CO., LTD.

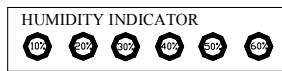
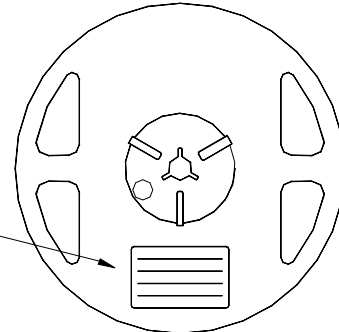

Aluminum Vinyl Bag

RANK: XXXX
 QUANTITY : XXXX
 LOT NUMBER : XXXXXXXXXXXX
 PART NUMBER : XXXXXXXX
 SEOUL SEMICONDUCTOR CO., LTD.

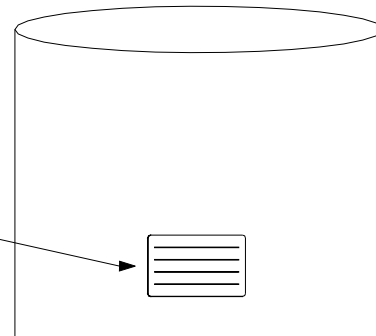

Outer Box Structure

Material : Paper(SW3B(B))

TYPE	SIZE (mm)		
	Ⓐ	Ⓑ	Ⓒ
7inch	245	220	102
	245	220	142

① SIDE

RANK: XXXX
 QUANTITY : XXXX
 LOT NUMBER : XXXXXXXXXXXX
 PART NUMBER : XXXXXXXX
 SEOUL SEMICONDUCTOR CO., LTD.

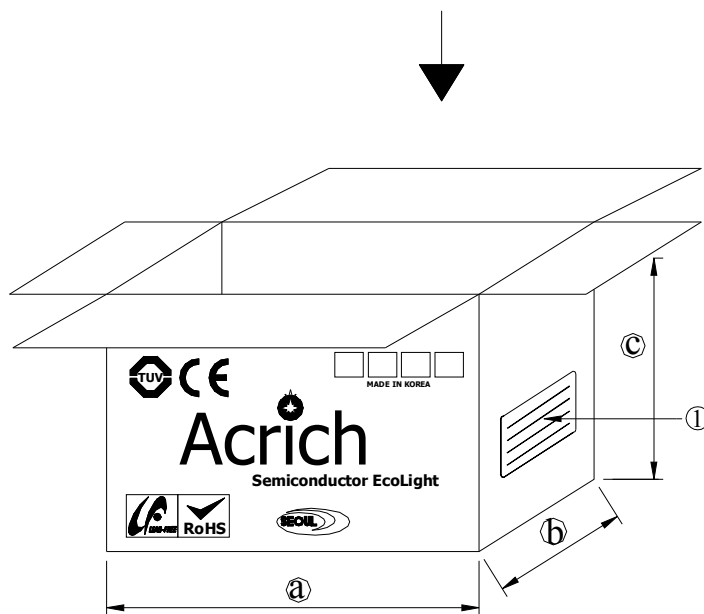

SSC-STW8T16C

June 2012

www.seoulsemicon.com

8. Packing

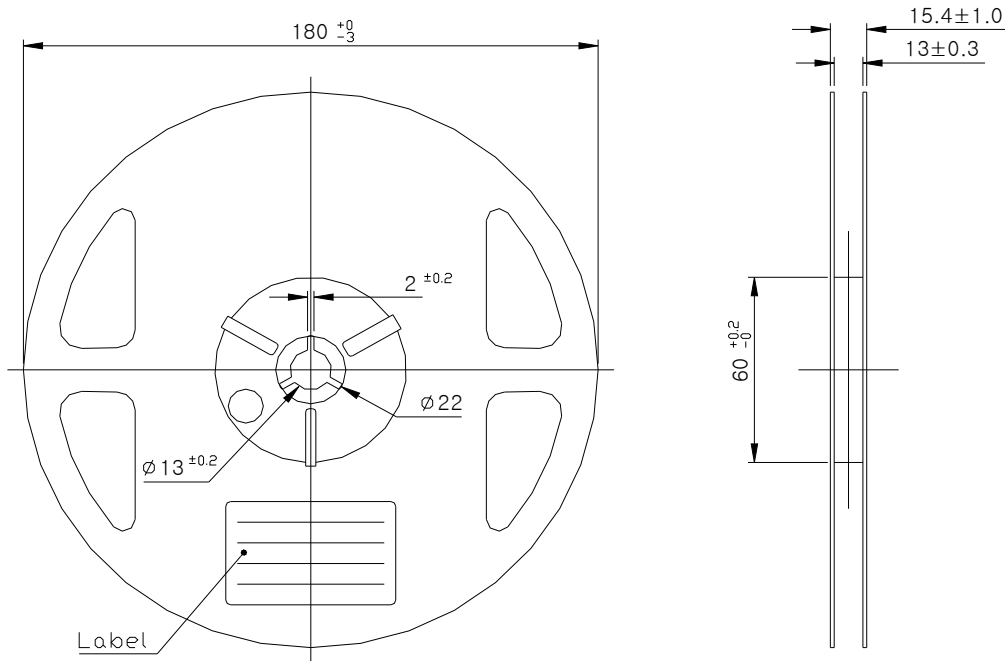
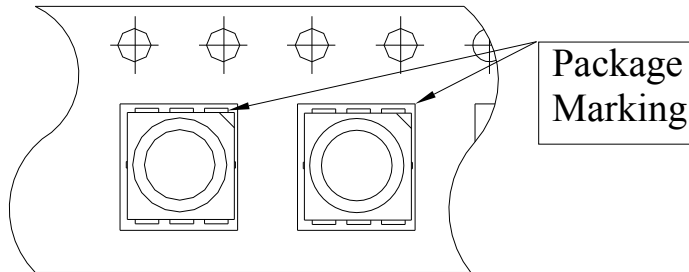
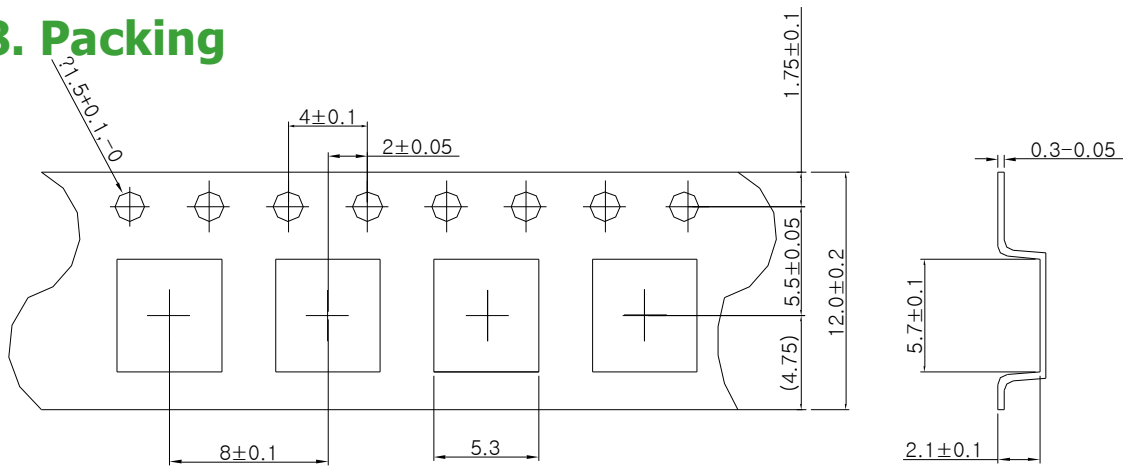

(Tolerance: ± 0.2 , Unit: mm)

- (1) Quantity : 1200pcs/Reel
- (2) Cumulative Tolerance : Cumulative Tolerance/10 pitches to be ± 0.2 mm
- (3) Adhesion Strength of Cover Tape : Adhesion strength to be 0.1-0.7N when the cover tape is turned off from the carrier tape at the angle of 10° to the carrier tape
- (4) Package : P/N, Manufacturing data Code No. and quantity to be indicated on a damp proof Package

SSC-STW8T16C

June 2012

www.seoulsemicon.com

9. Recommended solder pad

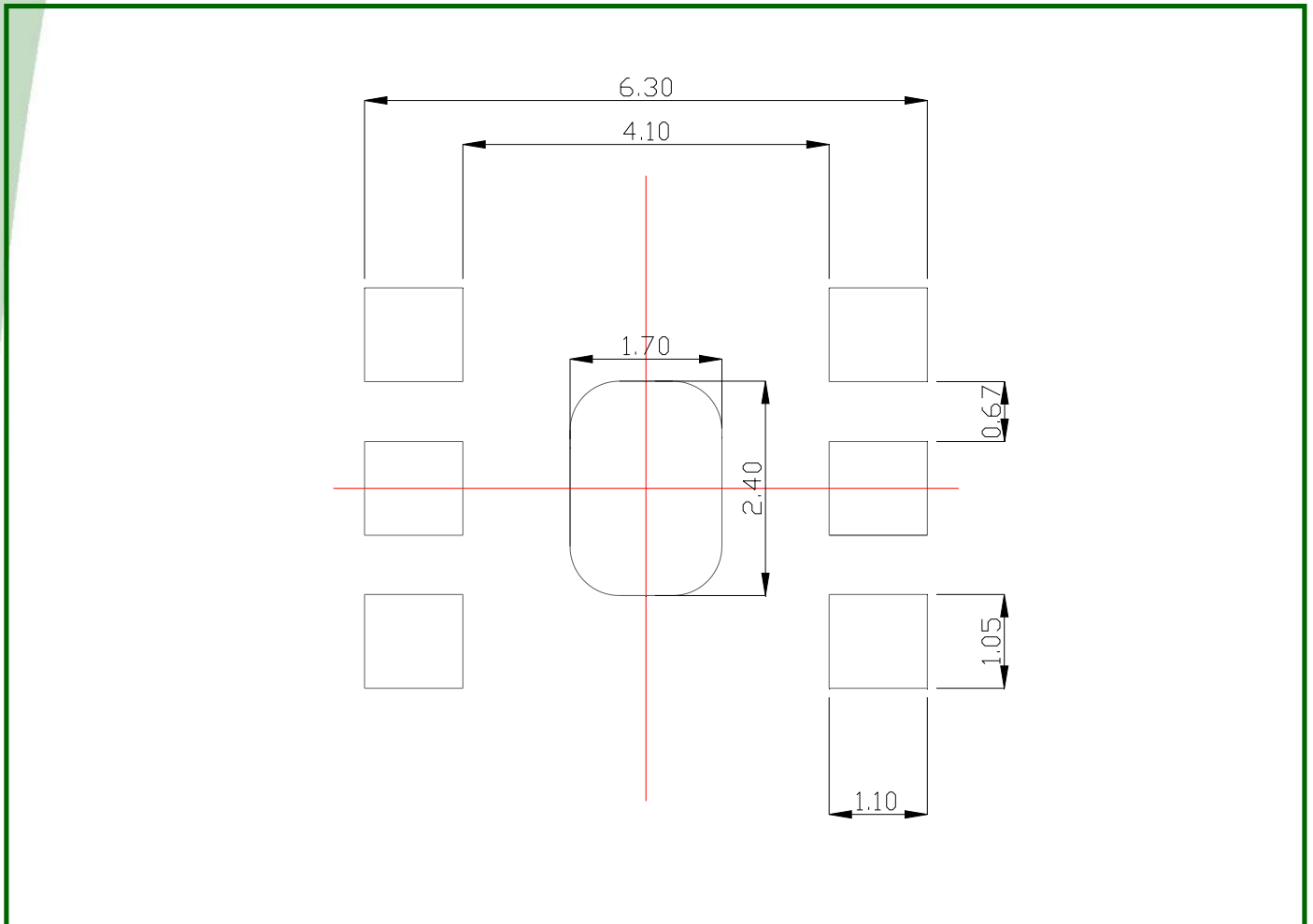

Notes :

- [1] All dimensions are in millimeters.
- [2] Scale : none
- [3] Undefined tolerance is $\pm 0.1\text{mm}$
This drawing without tolerances are for reference only

10. Soldering

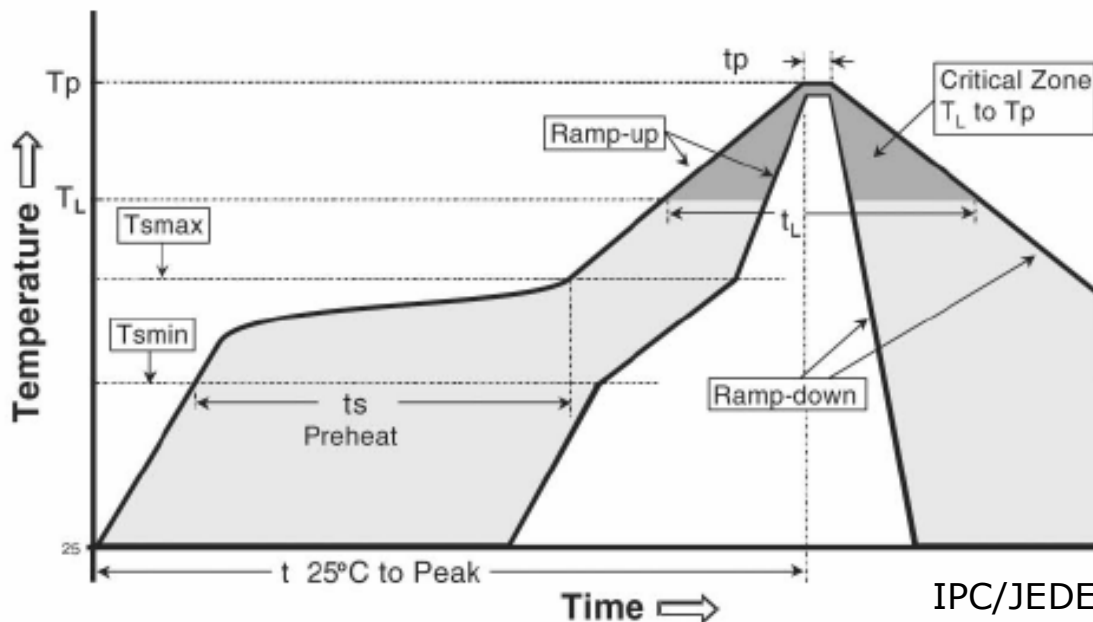

IPC/JEDEC J-STD-020

Profile Feature	Sn-Pb Eutectic Assembly	Pb-Free Assembly
Average ramp-up rate (T_{smax} to T_p)	3° C/second max.	3° C/second max.
Preheat - Temperature Min (T _{smin}) - Temperature Max (T _{smax}) - Time (T _{smin} to T _{smax}) (t _s)	100 °C 150 °C 60-120 seconds	150 °C 200 °C 60-180 seconds
Time maintained above: - Temperature (T _L) - Time (t _L)	183 °C 60-150 seconds	217 °C 60-150 seconds
Peak Temperature (T _p)	215 °C	260 °C
Time within 5°C of actual Peak Temperature (t _p) ²	10-30 seconds	20-40 seconds
Ramp-down Rate	6 °C/second max.	6 °C/second max.
Time 25°C to Peak Temperature	6 minutes max.	8 minutes max.

*** Caution**

1. Reflow soldering is recommended not to be done more than two times. In the case of more than 24 hours passed soldering after first, LEDs will be damaged.
2. Repairs should not be done after the LEDs have been soldered. When repair is unavoidable, suitable tools must be used.
3. Die slug is to be soldered.
4. When soldering, do not put stress on the LEDs during heating.
5. After soldering, do not warp the circuit board.

SSC-STW8T16C

June 2012

www.seoulsemicon.com

11. Precaution for use

(1) Storage

To avoid the moisture penetration, we recommend store in a dry box with a desiccant . The recommended storage temperature range is 5C to 30C and a maximum humidity of RH50%.

(2) Use Precaution after Opening the Packaging

Use proper SMD techniques when the LED is to be soldered dipped as separation of the lens may affect the light output efficiency.

Pay attention to the following:

a. Recommend conditions after opening the package

- Sealing

- Temperature : 5 ~ 40℃ Humidity : less than RH30%

b. If the package has been opened more than 1 week(MSL_3) or the color of the desiccant changes, components should be dried for 10-12hr at 60±5℃

(3) Do not apply mechanical force or excess vibration during the cooling process to normal temperature after soldering.

(4) Do not rapidly cool device after soldering.

(5) Components should not be mounted on warped (non coplanar) portion of PCB.

(6) Radioactive exposure is not considered for the products listed here in.

(7) Gallium arsenide is used in some of the products listed in this publication. These products are dangerous if they are burned or shredded in the process of disposal. It is also dangerous to drink the liquid or inhale the gas generated by such products when chemically disposed of.

(8) This device should not be used in any type of fluid such as water, oil, organic solvent and etc. When washing is required, IPA (Isopropyl Alcohol) should be used.

(9) When the LEDs are in operation the maximum current should be decided after measuring the package temperature.

(10) LEDs must be stored properly to maintain the device. If the LEDs are stored for 3 months or more after being shipped from SSC, a sealed container with a nitrogen atmosphere should be used for storage.

(11) The appearance and specifications of the product may be modified for improvement without notice.

(12) Long time exposure of sunlight or occasional UV exposure will cause lens discoloration.

(13) VOCs (Volatile organic compounds) emitted from materials used in the construction of fixtures can penetrate silicone encapsulants of LEDs and discolor when exposed to heat and photonic energy. The result can be a significant loss of light output from the fixture.

Knowledge of the properties of the materials selected to be used in the construction of fixtures can help prevent these issues.

(14) Attaching LEDs, do not use adhesives that outgas organic vapor.

(15) The driving circuit must be designed to allow forward voltage only when it is ON or OFF. If the reverse voltage is applied to LED, migration can be generated resulting in LED damage.

SSC-STW8T16C

June 2012

12. Handling of Silicone Resin LEDs

(1) During processing, mechanical stress on the surface should be minimized as much as possible. Sharp objects of all types should not be used to pierce the sealing compound.



(2) In general, LEDs should only be handled from the side. By the way, this also applies to LEDs without a silicone sealant, since the surface can also become scratched.

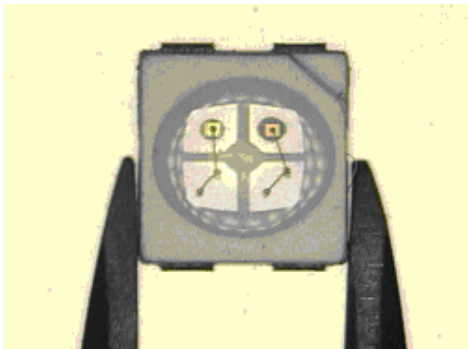

(3) When populating boards in SMT production, there are basically no restrictions regarding the form of the pick and place nozzle, except that mechanical pressure on the surface of the resin must be prevented. This is assured by choosing a pick and place nozzle which is larger than the LED's reflector area.

(4) Silicone differs from materials conventionally used for the manufacturing of LEDs. These conditions must be considered during the handling of such devices. Compared to standard encapsulants, silicone is generally softer, and the surface is more likely to attract dust.

As mentioned previously, the increased sensitivity to dust requires special care during processing. In cases where a minimal level of dirt and dust particles cannot be guaranteed, a suitable cleaning solution must be applied to the surface after the soldering of components.

(5) SSC suggests using isopropyl alcohol for cleaning. In case other solvents are used, it must be assured that these solvents do not dissolve the package or resin. Ultrasonic cleaning is not recommended. Ultrasonic cleaning may cause damage to the LED.

(6) Please do not mold this product into another resin (epoxy, urethane, etc) and do not handle this product with acid or sulfur material in sealed space.

SSC-STW8T16C

June 2012

www.seoulsemicon.com

