

Product Overview

The 7021 and 7023 BuckPlus LED Power Modules are a line of true current regulated drivers for powering LEDs. The BuckPlus line of LED drivers are the ideal choice for powering all types of high-brightness and high-power LED Packages and LED arrays.

The line of BuckPlus LED drivers exhibit high efficiency and require no external current limiting resistors or additional heat sinking for operation. A fast response current-sensing circuit makes the 7021 and 7023 ideal for applications where flashing or strobe operation of the LED(s) is required.

A wide range of options are available including external dc analog voltage intensity control, TTL/CMOS logic level on/off control ("E" Version), and set-and-forget internal current limiting ("I" Version). The standard units are fully potted in an extremely small form factor* and are provided with a simple 7 pin SIP connection for through-hole PCB mounting (7021) or 6" 24AWG Colored Leads (7023).

The 7021 and 7023's built-in regulated 5V reference (E and I versions) can provide output to power logical circuitry or microprocessor, eliminating the need for an additional power supply on the circuit board.

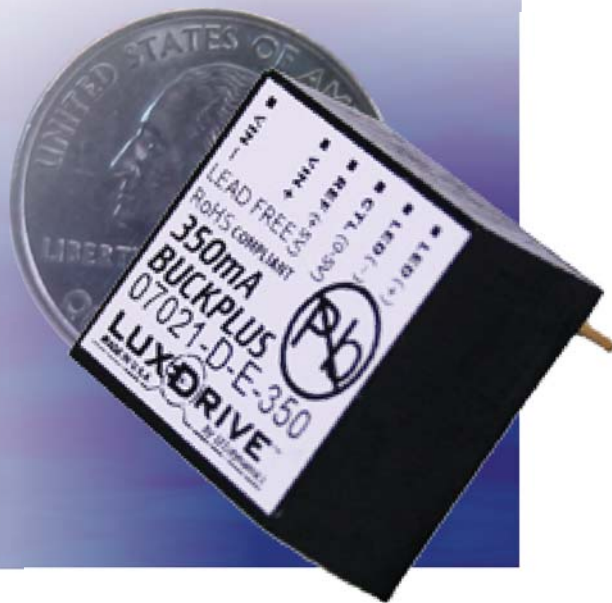

Features

- DC input voltage up to 32V
- 350mA, 500mA, 700mA, or 1.0A constant current output*
- Extremely small form factor* (0.83"x0.83"x0.43")
- The 7021 has a simple 7-pin SIP connection for through-hole PCB mounting or use with an optional wiring harness (7021Hx)
- The 7023 has permanently attached wires
- External analog/digital intensity control (TTL compatible)
- Optional external potentiometer intensity control (0-100%)
- Optional on-board trim adjustment (40-110%)
- Output short circuit protection up to 15 seconds
- Output open circuit protection
- Pulse and strobe capable (control input)
- Built-in 5V reference/output to power logic circuitry or μ Processor

Typical Applications

- Solar & Landscape Lighting
- Architectural Lighting
- Track Lighting
- Automotive & Marine Lighting
- Portable Lighting & Flashlights
- Point of Purchase Lighting
- Desk & Reading Lamps
- Signal & marker Lighting
- Flashing & Strobe Lighting
- Cabinet & Display Case Lighting
- Sign & Channel Letters
- Much More...

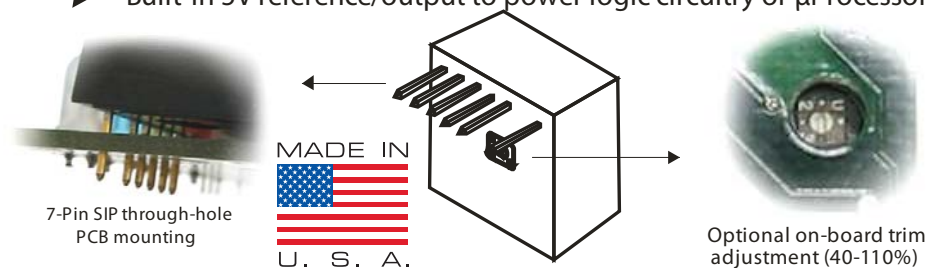

* - Custom units can be designed for OEM applications. Contact LUXdrive for more information.

©2010 LUXdrive, A Division of LEDdynamics, Inc. www.LUXdrive.com.
Specifications subject to change without notice. April, 2010 - Rev 2.2

Part Number Identification Table

Table 1
Product Selection

Part Number	DC Input	On-Board Trim	Control/Dimming	Connection Type
7021-D-N-xxxx	5-32V	no	no	7-Pin SIP (4 Pins)
7021-D-E-xxxx	7-32V	no	yes	7-Pin SIP (6 Pins)
7021-D-I-xxxx	7-32V	yes	yes	7-Pin SIP (6 Pins)
7023-D-N-xxxx	5-32V	no	no	4 Wires
7023-D-E-xxxx	7-32V	no	yes	6 Wires

XXXX - Output current rating in milliamperes (mA): 350, 500, 700, 1000 or special order factory custom rating

Absolute Maximum Ratings

Input Voltage	32V _{DC}
Output Voltage	32V _{DC}
Control Pin Voltage	10V
Reference regulator current (5V _{DC}) Output	20mA

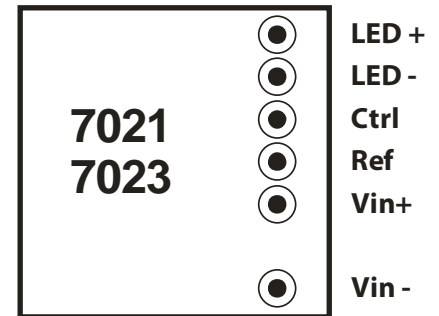

Typical Characteristics

Output tolerance (within specified temp. range)	±10%
Efficiency	95%
Input Voltage Minimum	5V _{DC} (N), 7V _{DC} (E or I)
Input Margin (350mA unit ¹ , add to LED Vf MAX)	2.5V _{DC}

Figure 1.
Bottom view Pinout of the
7021/7023 BuckPlus

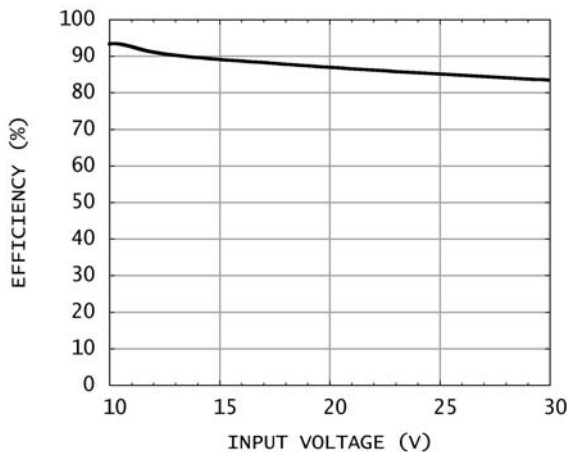

Figure 2.
Efficiency vs. Vin

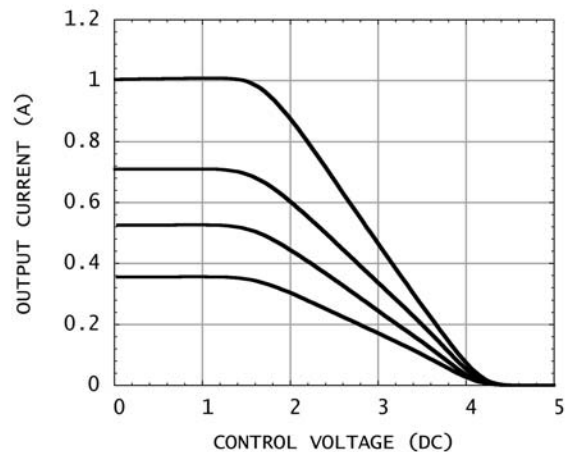

Figure 3.
Output current vs. control voltage

1 - Margin increases with higher current units.

Specifications

Output current, 7021-x-x-350, 7023-x-x-350	350mA ¹
Output current, 7021-x-x-500, 7023-x-x-500	500mA ¹
Output current, 7021-x-x-700, 7023-x-x-700	700mA ¹
Output current, 7021-x-x-1000, 7023-x-x-1000	1000mA ¹
Control Pin, adjustment threshold	1.65 V ±5%
Control Pin, shutoff threshold	4.2 V ±5%
Control Pin, propagation delay to output	<15 μs
Control Pin, input impedance	1.5k ohm
Reference voltage (V _{in} = 7V or greater)	5 V _{DC} ±5% ²
Optional trim pot adjustment range	40%-110%
External pot adjustment range	0%,1-100% ²
Maximum flash frequency	10 kHz
Minimum strobe pulse width	50 μs
Output rise time	<10 μs ³
Output fall time	<350 μs ³
Quiescent current (no load or control pin high)	<4.5 mA ³
Operating temperature (T _{case})	-40+80°C
Storage temperature	-40+125°C

Application Information

Description

The 7021/7023 Wide Range LED Power Module is a high efficiency dc to dc converter which delivers a fixed output current by varying the output voltage as required to maintain the specified current . A fast response current-sensing circuit permits the unit to be used in applications where flashing or pulsing of the LEDs is required. Several options are available allowing for use with many types of LEDs and in a variety of operating modes

Fixed Current Drive

The fixed output versions of the 7021/7023 are designed to supply their rated current to one or more LED junctions. For example, a 350 mA rated unit will drive up to six white 350mA LEDs connected in series at 24VDC. Due to the nature of the buck regulator, the input voltage must always be higher than the total forward voltage drop of the LEDjunction(s) connected in series (2.5V. Thus, for a series string of six junctions having an average forward drop of 3.5Veach, the required minimum input voltage will be 21V_{DC}. A standard 24V_{DC} power supply is a good choice for this application.

Figures 4 through 6 show 700mA and 1000mA rated units driving multiple LEDs. Note that parallel strings of LEDs can be driven directly with no additional circuitry required to insure current sharing. The nature of the LEDs themselves will provide sufficient current sharing if the parallel strings comprise 3 or more junctions each.

1 - Measured with single emitter; output current drops slightly with additional series junctions to limit maximum power dissipation.

2 - When V_{in} > 7VDC

3 - Actual value varies greatly based on input and/or output voltages. Value shown is for V_{in} = 24V_{DC} V_{out}=20V_{DC} LED load. Actual values will be smaller in most applications.

Adjustable Current - On-Board Control - "I" Model

Where the ability to adjust the output current to an intermediate value is required, all output current ratings are available with an on-board potentiometer. This permits the output current to be varied from approximately 40% to 110% of the rated value. When measuring the output is required to determine a particular set point, the following method is recommended:

- Temporarily place a 0.1 ohm, 1% resistor in series with the LEDs.
- Read the voltage across the 0.1 ohm resistor.
- The voltage, in millivolts X 10, will equal the output current in mA.

Because there is a small, high-frequency component in the 7021/7023 output, many multi-meters may give an incorrect reading when used in the current mode. It has been found that the method described above yields a far more accurate measurement.

The potentiometers used for the on-board adjustable units are rated for a limited number of rotations (typically 100) and are intended for "set it and forget it" applications. Where frequent adjustments of output current are needed, the use of units with external adjustment capabilities is recommended.

Adjustable Current - External Control - "E" Model

Figures 10 and 11 show external adjustment configurations. Both use a 5Kohm, linear taper potentiometer. In Figure 10, the potentiometer is connected between the internal 5V_{DC} reference (Ref) output and the control (Ctrl) input. When using this configuration, it is important that Vin be 7V_{DC} or higher. Figure 11 shows the control potentiometer being powered by an external 5V_{DC} source. When using an external power source for the potentiometer, the source ground must be common to the LED- output pin. In either configuration, connect the potentiometer such that clockwise rotation increases the resistance. Note that, because the current through the potentiometer is less than 5mA, a low power potentiometer may be used.

External On/Off Control

Where a manual on/off control is desired, the potentiometer in Figures 10 and 11 may be replaced by a pushbutton or toggle switch. The output current will be zero when the switch is closed. Figures 12 and 13 show external dimming control combined with on/off control. The circuit in Figure 13 uses a 2N3906 or equivalent PNP switching transistor.

External Pulse/Strobe Control

Figures 14 and 15 show two methods for low speed pulsing or high speed flashing operation. In Figure 14, a 5V TTL/CMOS logic signal is applied directly to the control (Ctrl) input of the 7021/7023. The output current will be zero when the control signal is high. Note that the input needs to source a minimum of 4.75V_{DC} into a 1.5Kohm input impedance. Also, as is the case with a dc control signal, the logic input ground should be common to the LED- output terminal.

Figure 15 shows an inverted input configuration using a 2N3906 or other PNP switching transistor. In this case, a logic high will cause the output to be "on". In either configuration, the rise time of the output will be 10µsec or less. A pulse frequency up to 10kHz may be used.

Microprocessor Control

Figure 16 shows a typical interface for a Microchip PIC® or similar μ controller. The reference output provides the operating voltage for the processor (5V at up to 20mA current).

Other Control Applications

In addition to the configurations described above, the 7021/7023 may also be driven by a D to A converter. As in the cases above, the analog control signal should have its ground common to LED-. Figure 2 shows the effective control range of the analog input signal.

Connections

In all cases, the LEDs being driven should be located as close to the 7021/7023 LED output as possible. When the use of long leads is required, use heavier gauge wire. For strobe or pulse applications, a wire length not exceeding 6" should be used to maintain accurate timing.

The power input wires/traces should also be kept short. Where DC input units are located more than 18" from the source, a 220 μ F, 50V capacitor should be placed across the input terminals as shown in Figure 18.

For applications where the use of header pins is inconvenient, a mating connector with 6" leads is available as an accessory, or the 7023 part number may be used, which is supplied with 6" colored leads.

- 7021HN** - Harness for "N" type (4-wire)
- 7021HE** - Harness for "E" & "I" type (6-wire)
- 7021HEP** - Harness for "E" & "I" w/pot (6-wire w/pot)

Application Figures

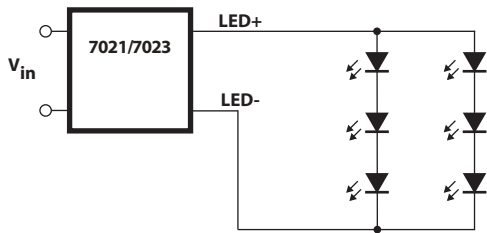

Figure 4.
700 MA unit driving 6 High Power LEDs
(VIN \geq 12VDC)

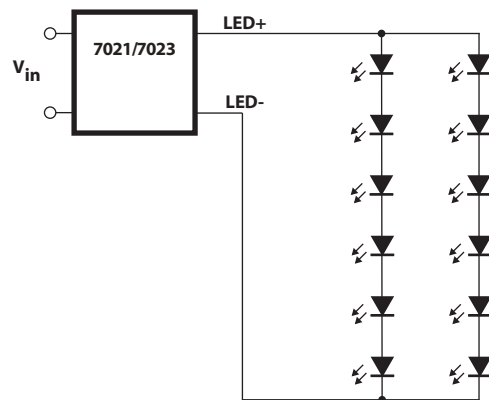

Figure 5.
700mA unit driving 12 High Power LEDs
(VIN \geq 24VDC)

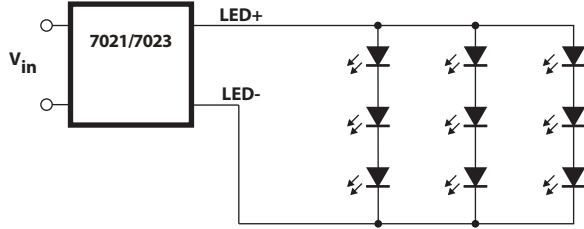

Figure 6.
1000mA unit driving nine High Power LEDs
at 1W each ($V_{IN} \geq 12VDC$)

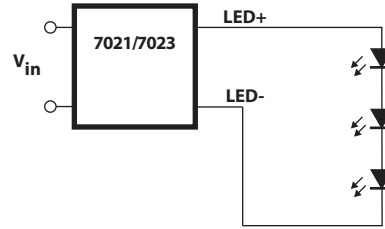

Figure 7.
1000mA unit driving three High Power LEDs
at 3W each ($V_{IN} \geq 12VDC$)

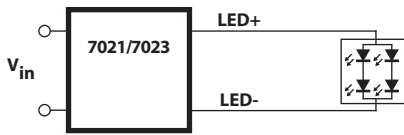

Figure 8.
700mA unit driving one Cree MC-E emitter
($V_{IN} \geq 8VDC$)

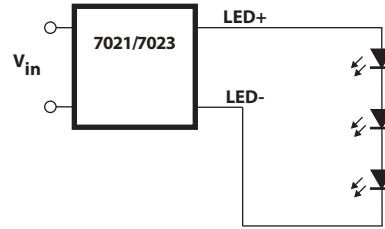

Figure 9.
700mA unit driving three High Power LEDs
at 2W each ($V_{IN} \geq 12VDC$)

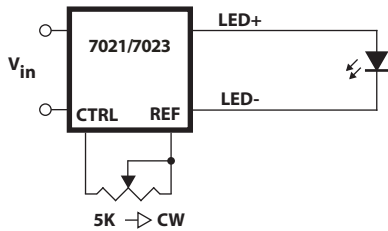

Figure 10.
External potentiometer using internal
reference

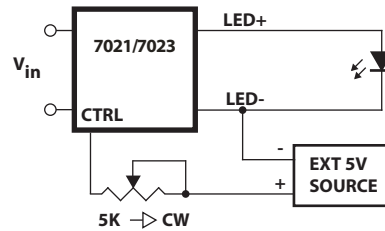

Figure 11.
External potentiometer using external voltage
source

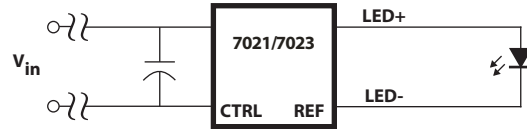
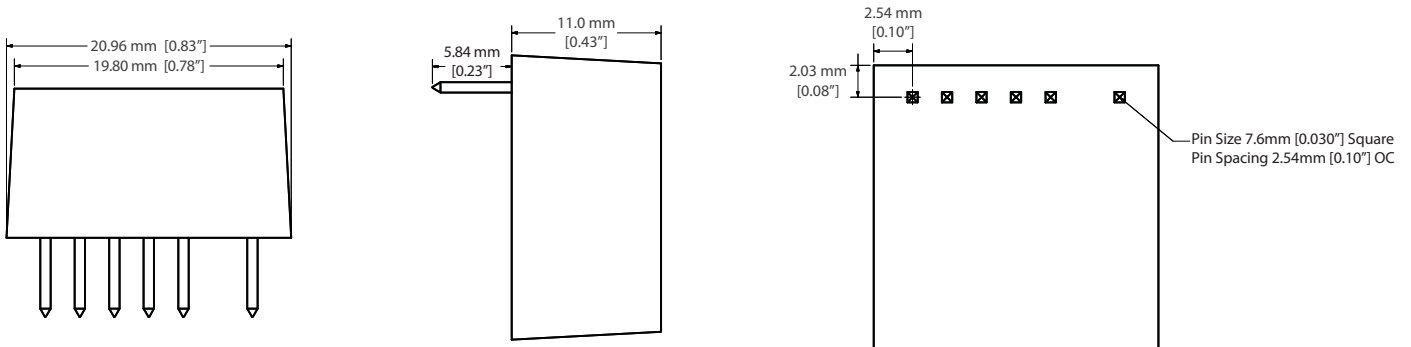

Figure 18.
Place a capacitor across the input terminals when the distance to the DC power source is greater than 18 inches

Physical Dimensions



7021

7023

6" - 24AWG Colored Leads

