

Bridgelux Micro SM4 Star

Product Data Sheet DS29

Introduction

The Bridgelux Micro SM4 Star delivers high performance, compact and cost-effective solid-state lighting solutions to serve general and specialty lighting applications. These products combine the higher efficacy, lifetime, and reliability benefits of LEDs with the light output levels of low wattage conventional light sources. The Bridgelux Micro SM4 Star series has been designed to enable a cost-effective design for LED retrofit bulbs, halogen spotlights, consumer luminaires and other general lighting applications.

The Bridgelux Micro SM4 Star provides a high performance alternative to conventional solid state solutions from 2700K warm-white to 5600K cool-white color temperatures. These compact high flux density light sources enable both diffuse and directional lamp replacements for a wide range of applications.

Lighting system designs incorporating these products deliver performance comparable to that of a 20-40 Watt incandescent, 20-35 Watt halogen and low wattage compact fluorescent lamps and luminaires and feature increased system level efficacy and service life. Typical applications include replacement lamps, task lighting, under cabinet, accent, pendant, sconces, porch, pathway, landscape, portable, consumer luminaires and consumer white goods.

Features

- Compact high flux density light source
- Low thermal resistance and electrically neutral thermal path
- Energy Star / ANSI based 4-step color space with 3-step binning options
- Available in 350mA (12V) and 700mA (6V) versions
- More energy efficient than incandescent, halogen and fluorescent lamps
- Low voltage DC operation
- Instant light with unlimited dimming
- 5-year warranty
- RoHS compliant and Pb free

Benefits

- Enhanced optical control
- Increased design flexibility and operating temperature range
- Consistent white light
- Enables driver design flexibility and low voltage lighting products
- Lower operating costs
- Increased safety
- Easy to use with daylight and motion detectors to enable increased energy savings
- Reduced maintenance costs
- Environmentally friendly, no disposal issue

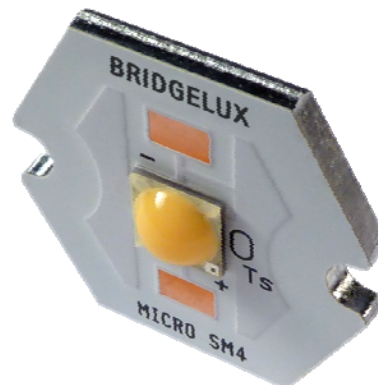

Table of Contents

Page

Product Nomenclature	3
Average Lumen Maintenance Characteristics	3
Environmental Compliance	3
UL Recognition.....	4
Minor Product Change Policy	4
Cautionary Statements.....	4
Quick Selection Guide.....	5
Flux Characteristics.....	6
Optical Characteristics	7
Electrical Characteristics.....	8
Absolute Maximum Ratings	9
Mechanical Dimensions	10
Typical Radiation Pattern.....	11
Wavelength Characteristics at Rated Test Current, $T_j=25^{\circ}\text{C}$	11
Typical Relative Luminous Flux vs. Current, $T_j=25^{\circ}\text{C}$	11
Typical Light Output Characteristics vs. Temperature.....	13
Typical Chromaticity Characteristics vs. Temperature	14
Typical Forward Current Characteristics.....	15
Color Binning Information.....	16
Product Packaging and Labeling	21
Design Resources.....	22

Product Nomenclature

The part number designation for the Bridgelux Micro SM4 Star is explained as follows:

BXPX – AB C DEFG – H – JJKK – SB

Where:

BXPX – Designates product family; Micro SM4

AB – Designates the nominal ANSI color temperature; 27 = 2700K; 30 = 3000K, etc.

C - Designates minimum CRI; C = 70, E = 80, G = 90

DEFG - Designates Nominal Flux; 0400 = 400lm, 0520 = 500lm, etc.

H – Designates configuration; A = 350mA (12V); B = 700mA (6V)

JJ – Designates color bin options

03 = 3 SDCM

04 = 4 SDCM

KK – Reserved. Default = 00

SB – Form Factor; Star Board

Average Lumen Maintenance Characteristics

Bridgelux projects that its Micro SM4 Star family of products will deliver, on average, greater than 70% lumen maintenance after 50,000 hours of operation at the applicable 350mA/700mA test current. This performance assumes constant current operation with temperature solder measurement point (T_s) maintained at or below 85°C. For use beyond these typical operating conditions please consult your Bridgelux sales representative for further assistance.

These projections are based on a combination of package test data, semiconductor chip reliability data, a fundamental understanding of package related degradation mechanisms, and performance observed from products installed in the field using Bridgelux die technology. Bridgelux conducts lumen maintenance tests per LM80 and L70 lifetime predictions in accordance to TM-21-11. Observation of design limits is required in order to achieve this projected lumen maintenance.

Environmental Compliance

Bridgelux is committed to providing environmentally friendly products to the solid-state lighting market. Bridgelux LEDs are compliant to the European Union directives on the restriction of hazardous substances in electronic equipment, namely the RoHS directive. Bridgelux will not intentionally add the following restricted materials to LED products: lead, mercury, cadmium, hexavalent chromium, polybrominated biphenyls (PBB) or polybrominated diphenyl ethers (PBDE).

UL Recognition

Bridgelux secures UL Recognition for all the LED products. Bridgelux uses UL Recognized materials with suitable flammability ratings to streamline the process for customers to secure UL listing of the final luminaire product (certification pending).

Minor Product Change Policy

The rigorous qualification testing on products offered by Bridgelux provides performance assurance. Slight cosmetic changes that do not affect form, fit, or function may occur as Bridgelux continues product optimization.

Cautionary Statements

CAUTION: CONTACT WITH OPTICAL AREA

Contact with the silicone lens should be avoided. Applying stress to the silicone lens can result in damage to the product.

CAUTION: EYE SAFETY

Eye safety classification for the use of the Bridgelux Micro SM4 Star product series is in accordance with IEC – EN62471 Photobiological Safety of Lamps and Lamp Systems specification. These products are classified as Risk Group 1 (Low Risk) when operated at or below the rated test current. Please use appropriate precautions. It is important that employees working with LEDs are trained to use them safely.

CAUTION: RISK OF BURN

Do not touch the LED during operation. Allow the LED to cool for a sufficient period of time before handling. The LED may reach elevated temperatures such that it can burn skin when touched.

CAUTION: CHEMICAL EXPOSURE HAZARD

Exposure to some chemicals commonly used in luminaire manufacturing and assembly can cause damage to the LED. Please consult Bridgelux Application Note AN21 for additional information.

Quick Selection Guide

Table 1: Selection Guide for Bridgelux Micro SM4 Star

Orderable Part Number	CCT (Nominal)	CRI (min)	Typical Pulsed Flux $T_j = 25^\circ\text{C}$ (lm)	Test Current (mA)	Typical Vf (V)	Typical Power Dissipation (W)	Typical Efficacy $T_j = 25^\circ\text{C}$ (lm/W)
BXPX-27E0400-A-0300-SB BXPX-27E0400-A-0400-SB	2700K	80	380	350	12.2	4.25	89
BXPX-27E0400-B-0300-SB BXPX-27E0400-B-0400-SB	2700K	80	380	700	6.1	4.25	89
BXPX-27G0400-A-0300-SB BXPX-27G0400-A-0400-SB	2700K	90	300	350	12.2	4.25	70
BXPX-27G0400-B-0300-SB BXPX-27G0400-B-0400-SB	2700K	90	300	700	6.1	4.25	70
BXPX-30E0400-A-0300-SB BXPX-30E0400-A-0400-SB	3000K	80	400	350	12.2	4.25	94
BXPX-30E0400-B-0300-SB BXPX-30E0400-B-0400-SB	3000K	80	400	700	6.1	4.25	94
BXPX-30G0400-A-0300-SB BXPX-30G0400-A-0400-SB	3000K	90	320	350	12.2	4.25	75
BXPX-30G0400-B-0300-SB BXPX-30G0400-B-0400-SB	3000K	90	320	700	6.1	4.25	75
BXPX-40C0500-A-0400-SB	4000K	70	440	350	12.2	4.25	103
BXPX-40C0500-B-0400-SB	4000K	70	440	700	6.1	4.25	103
BXPX-40E0400-A-0300-SB BXPX-40E0400-A-0400-SB	4000K	80	420	350	12.2	4.25	98
BXPX-40E0400-B-0300-SB BXPX-40E0400-B-0400-SB	4000K	80	420	700	6.1	4.25	98
BXPX-50C0500-A-0400-SB	5000K	70	480	350	12.2	4.25	112
BXPX-50C0500-B-0400-SB	5000K	70	480	700	6.1	4.25	112
BXPX-56C0520-A-0400-SB	5600K	70	500	350	12.2	4.25	117
BXPX-56C0520-B-0400-SB	5600K	70	500	700	6.1	4.25	117

Flux Characteristics

Table 2: Flux Characteristics

Color	ANSI CCT	Base Part Number	Typical DC Flux $T_j = 85^\circ\text{C}$ (lm)	Minimum Pulsed Flux $T_j = 25^\circ\text{C}$ (lm) ⁽¹⁾	Typical Pulsed Flux $T_j = 25^\circ\text{C}$ at test current ⁽²⁾		Typical Pulsed Flux $T_j = 25^\circ\text{C}$ at drive current	
					(lm)	(mA)	(lm)	(mA)
Warm White	2700K	BXPX-27E0400-A-0x00-SB	340	340	380	350	515	500
		BXPX-27E0400-B-0x00-SB	340	340	380	700	515	1000
		BXPX-27G0400-A-0x00-SB	270	280	300	350	405	500
		BXPX-27G0400-B-0x00-SB	270	280	300	700	405	1000
	3000K	BXPX-30E0400-A-0x00-SB	360	360	400	350	540	500
		BXPX-30E0400-B-0x00-SB	360	360	400	700	540	1000
		BXPX-30G0400-A-0x00-SB	280	300	320	350	430	500
		BXPX-30G0400-B-0x00-SB	280	300	320	700	430	1000
Neutral White	4000K	BXPX-40C0500-A-0400-SB	400	400	440	350	595	500
		BXPX-40C0500-B-0400-SB	400	400	440	700	595	1000
		BXPX-40E0400-A-0x00-SB	380	380	420	350	565	500
		BXPX-40E0400-B-0x00-SB	380	380	420	700	565	1000
Cool White	5000K	BXPX-50C0500-A-0400-SB	430	440	480	350	650	500
		BXPX-50C0500-B-0400-SB	430	440	480	700	650	1000
	5600K	BXPX-56C0520-A-0400-SB	450	460	500	350	675	500
		BXPX-56C0520-B-0400-SB	450	460	500	700	675	1000

Notes for Table 2:

1. Bridgelux maintains a $\pm 7\%$ tolerance on flux measurements.
2. Parts are tested in pulsed conditions, $T_j = 25^\circ\text{C}$. Pulse width is 10 ms at rated 350mA/700mA test current.

Optical Characteristics

Table 3: Optical Characteristics

Color	ANSI CCT	Base Part Number	Typical Color Temperature (CCT) ^{[1], [2], [3]}	CRI (min) ^[4]	Typical Viewing Angle (Degrees) $2\theta^{1/2}$ ^[5]
Warm White	2700K	BXPX-27E0400-A-0x00-SB	2725K	80	145
		BXPX-27E0400-B-0x00-SB	2725K	80	145
		BXPX-27G0400-A-0x00-SB	2725K	90	145
		BXPX-27G0400-B-0x00-SB	2725K	90	145
	3000K	BXPX-30E0400-A-0x00-SB	3045K	80	145
		BXPX-30E0400-B-0x00-SB	3045K	80	145
		BXPX-30G0400-A-0x00-SB	3045K	90	145
		BXPX-30G0400-B-0x00-SB	3045K	90	145
Neutral White	4000K	BXPX-40C0500-A-0400-SB	3985K	70	145
		BXPX-40C0500-B-0400-SB	3985K	70	145
		BXPX-40E0400-A-0x00-SB	3985K	80	145
		BXPX-40E0400-B-0x00-SB	3985K	80	145
Cool White	5000K	BXPX-50C0500-A-0400-SB	5028K	70	145
		BXPX-50C0500-B-0400-SB	5028K	70	145
	5600K	BXPX-56C0520-A-0400-SB	5665K	70	145
		BXPX-56C0520-B-0400-SB	5665K	70	145

Notes for Table 3:

1. Parts are tested in pulsed conditions, $T_j = 25^\circ\text{C}$. Pulse width is 10 ms at rated test current.
2. Refer to Flux Characteristic Table for test current data.
3. Product is binned for color in x, y coordinates.
4. Bridgelux maintains a ± 2 tolerance on CRI measurements.
The typical R9 value for 90 CRI base part numbers is 50.
5. Viewing angle is the off axis angle from the centerline where I_v is $\frac{1}{2}$ of the peak value.

Electrical Characteristics

Table 4: Electrical Characteristics

Color	Base Part Number	Forward Voltage Vf (V) ^{[2][3]}			Test Current (mA) ^[1]	Typical Coefficient of Forward Voltage (mV/°C) $\Delta V_f / \Delta T_j$	Typical Thermal Resistance Junction to MCPCB Underside (°C/W) $R_{\theta_{j-s}}$
		Min	Typ	Max			
Warm White	BXPX-27E0400-A-0x00-SB	11.6	12.2	12.6	350	-4 to -12	3.5
	BXPX-27E0400-B-0x00-SB	5.8	6.1	6.3	700	-2 to -6	3.5
	BXPX-27G0400-A-0x00-SB	11.6	12.2	12.6	350	-4 to -12	3.5
	BXPX-27G0400-B-0x00-SB	5.8	6.1	6.3	700	-2 to -6	3.5
	BXPX-30E0400-A-0x00-SB	11.6	12.2	12.6	350	-4 to -12	3.5
	BXPX-30E0400-B-0x00-SB	5.8	6.1	6.3	700	-2 to -6	3.5
	BXPX-30G0400-A-0x00-SB	11.6	12.2	12.6	350	-4 to -12	3.5
	BXPX-30G0400-B-0x00-SB	5.8	6.1	6.3	700	-2 to -6	3.5
Neutral White	BXPX-40C0500-A-0400-SB	11.6	12.2	12.6	350	-4 to -12	3.5
	BXPX-40C0500-B-0400-SB	5.8	6.1	6.3	700	-2 to -6	3.5
	BXPX-40E0400-A-0x00-SB	11.6	12.2	12.6	350	-4 to -12	3.5
	BXPX-40E0400-B-0x00-SB	5.8	6.1	6.3	700	-2 to -6	3.5
Cool White	BXPX-50C0500-A-0400-SB	11.6	12.2	12.6	350	-4 to -12	3.5
	BXPX-50C0500-B-0400-SB	5.8	6.1	6.3	700	-2 to -6	3.5
	BXPX-56C0520-A-0400-SB	11.6	12.2	12.6	350	-4 to -12	3.5
	BXPX-56C0520-B-0400-SB	5.8	6.1	6.3	700	-2 to -6	3.5

Notes for Table 4:

1. Parts are tested in pulsed conditions, $T_j = 25^\circ\text{C}$. Pulse width is 10 ms at rated test current.
2. Bridgelux maintains a tester tolerance of ± 0.10 V on forward voltage measurements.
3. The Anode and Cathode solder pads on the Micro SM4 Star product are supplied with a protective Organic Solderability Preservative (OSP) layer. Electrical wire should be soldered to these pads to effect a good connection. Probing through this OSP layer may provide a false forward voltage measurement.

Absolute Maximum Ratings

Table 5: Maximum Current and Reverse Voltage Ratings

Color	Base Part Number	Maximum DC Forward Current (mA)	Maximum Peak Pulsed Current (mA) ^[1]	Maximum Reverse Voltage (Vr) ^[2]
Warm White	BXPX-27E0400-A-0x00-SB	500	700	-20 V
	BXPX-27E0400-B-0x00-SB	1000	1400	-10 V
	BXPX-27G0400-A-0x00-SB	500	700	-20 V
	BXPX-27G0400-B-0x00-SB	1000	1400	-10 V
	BXPX-30E0400-A-0x00-SB	500	700	-20 V
	BXPX-30E0400-B-0x00-SB	1000	1400	-10 V
	BXPX-30G0400-A-0x00-SB	500	700	-20 V
	BXPX-30G0400-B-0x00-SB	1000	1400	-10 V
Neutral White	BXPX-40C0500-A-0400-SB	500	700	-20 V
	BXPX-40C0500-B-0400-SB	1000	1400	-10 V
	BXPX-40E0400-A-0x00-SB	500	700	-20 V
	BXPX-40E0400-B-0x00-SB	1000	1400	-10 V
Cool White	BXPX-50C0500-A-0400-SB	500	700	-20 V
	BXPX-50C0500-B-0400-SB	1000	1400	-10 V
	BXPX-56C0520-A-0400-SB	500	700	-20 V
	BXPX-56C0520-B-0400-SB	1000	1400	-10 V

Notes for Table 5:

1. Bridgelux recommends a maximum duty cycle of 10% when operating LEDs at the maximum peak pulsed current specified.
2. Light emitting diodes are not designed to be driven in reverse voltage.

Table 6: Maximum Ratings

Parameter	Maximum Rating
LED Junction Temperature	150°C
Storage Temperature	-40°C to +135°C
Operating Temperature Range - solder measurement point (T _s)	105°C at applicable 350mA/700mA test current, 85°C at maximum drive current
ESD Classification	Class 3A (4000V HBM per JESD22-A114-F)

Mechanical Dimensions

Figure 1: Mechanical Dimensions for Bridgelux Micro SM4 Star

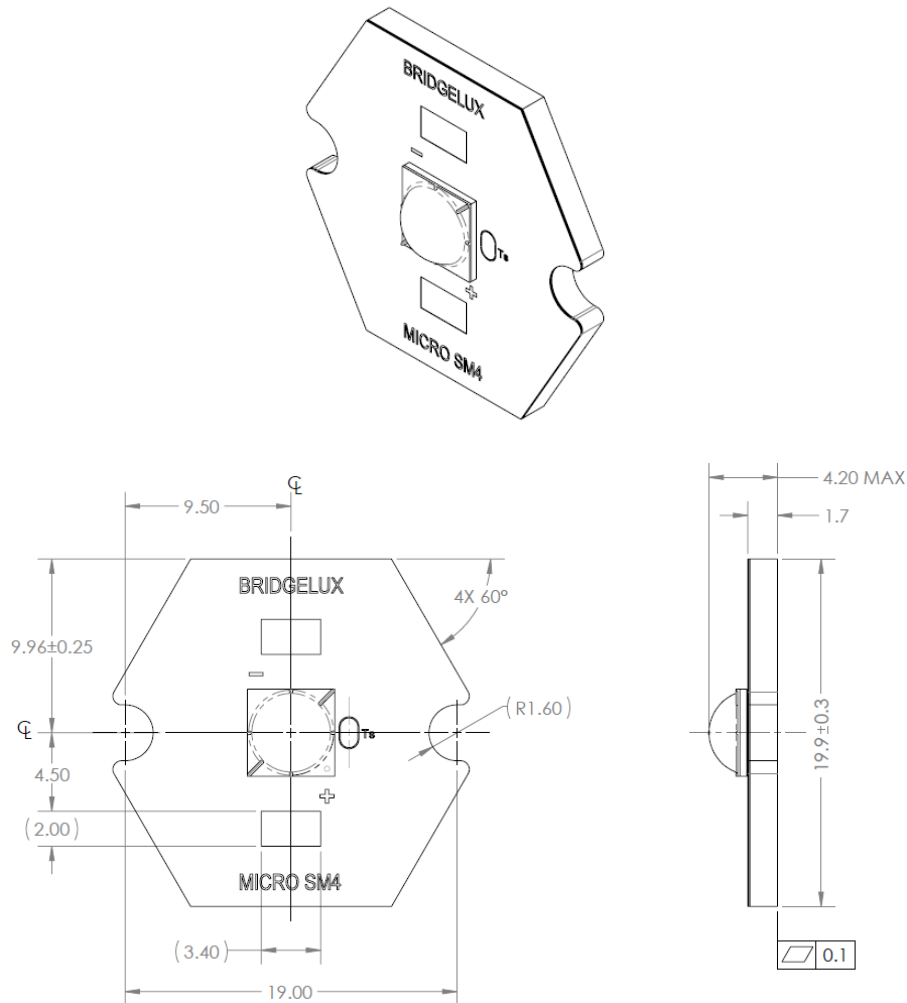

Notes for Figure 1:

1. Drawing is not to scale.
2. Drawing dimensions are in millimeters.
3. Unless otherwise specified, tolerances are $\pm 0.20\text{mm}$.
4. The optical center of the LED is defined by the mechanical center of the product
5. The Anode and Cathode solder pads on the Micro SM4 Star product are supplied with a protective Organic Solderability Preservative (OSP) layer. Electrical wire should be soldered to these pads to effect a good connection. Probing through this OSP layer may provide a false forward voltage measurement.
6. 3D CAD model available at www.bridgelux.com

Typical Radiation Pattern

Figure 2: Typical Far Field Radiation Pattern

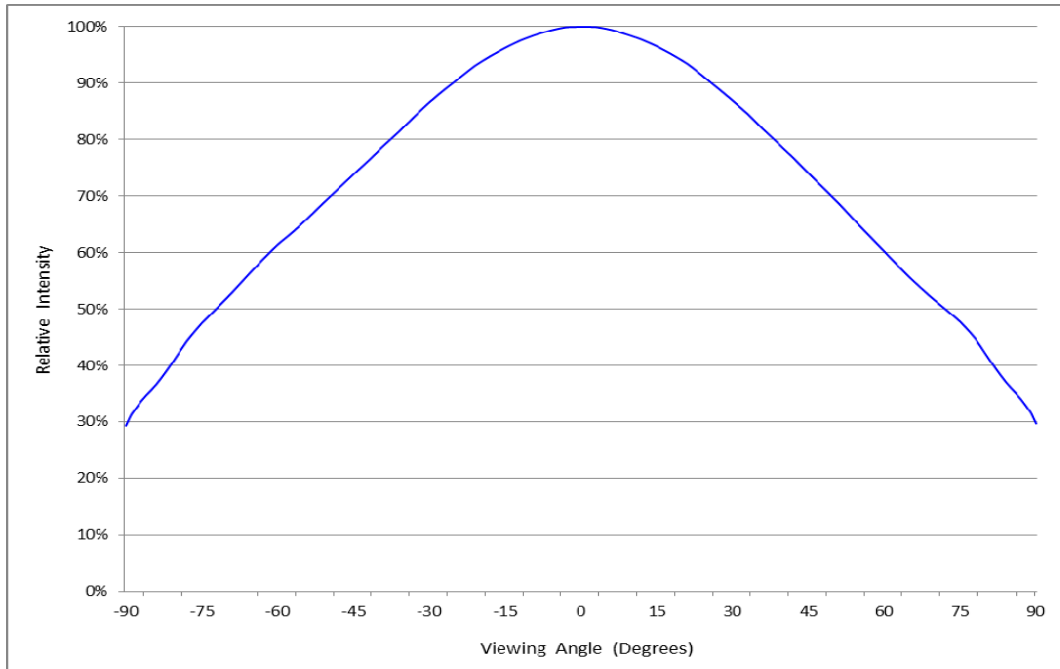

Wavelength Characteristics at Rated Test Current, $T_j=25^{\circ}\text{C}$

Figure 3: Typical Warm-White, Neutral-White and Cool-White Color Spectrum

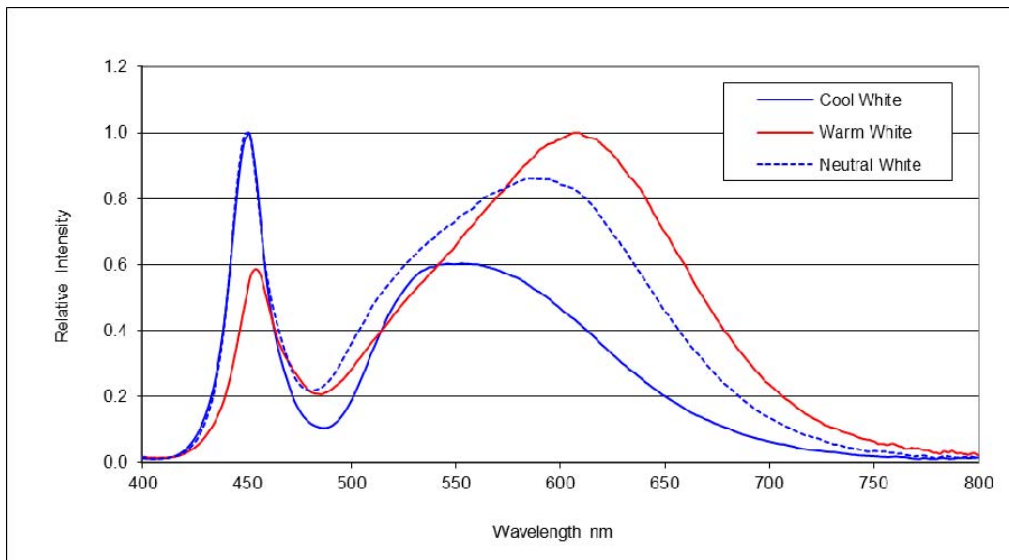

Typical Luminous Flux vs. Current, $T_j=25^\circ\text{C}$

Figure 4: Typical Luminous Flux versus Current
350mA 12V Stars (BXPX-xxxxxxx-A-0x00-SB product series)

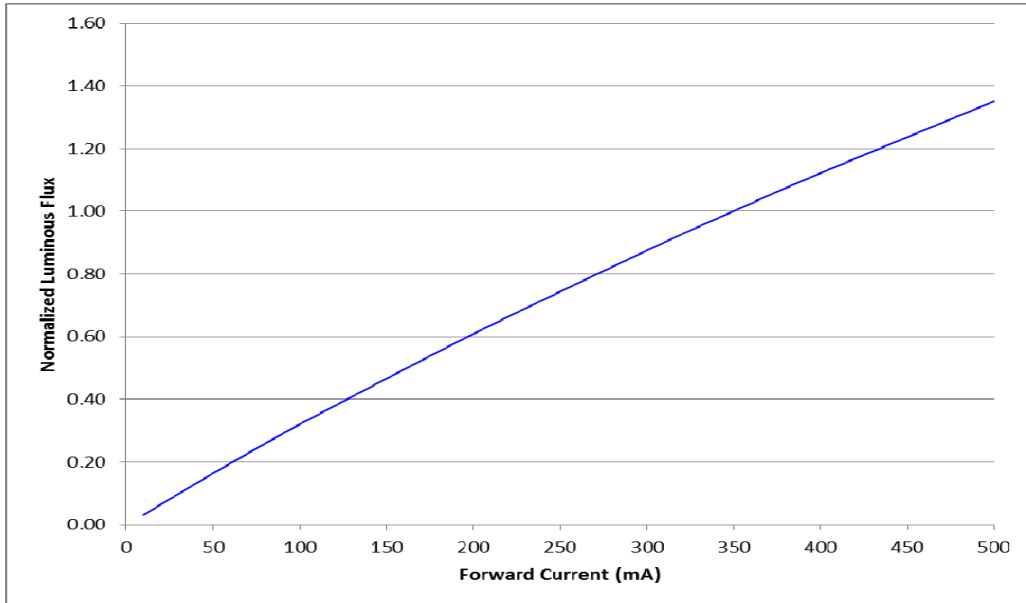
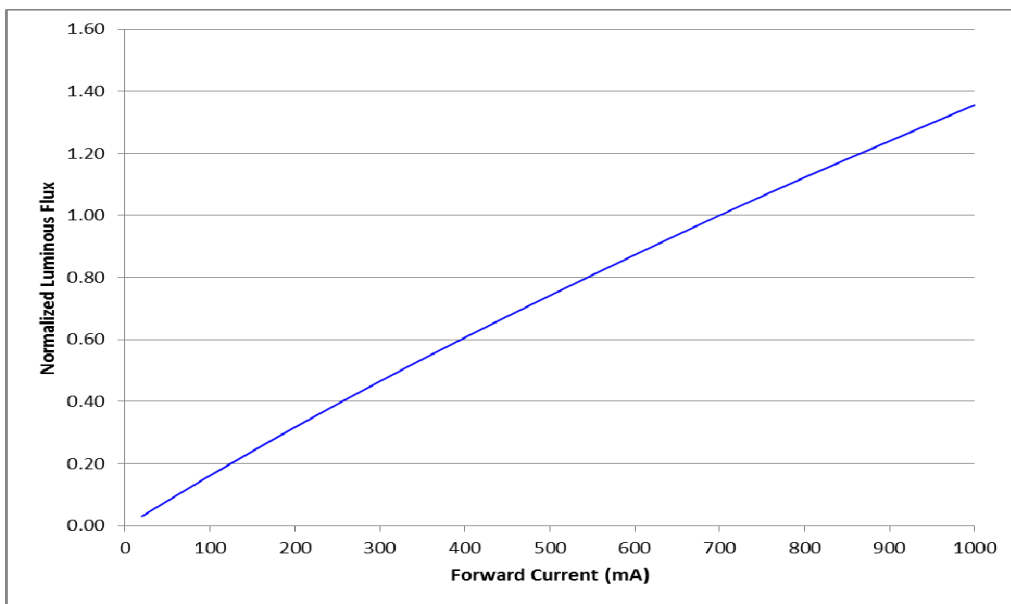
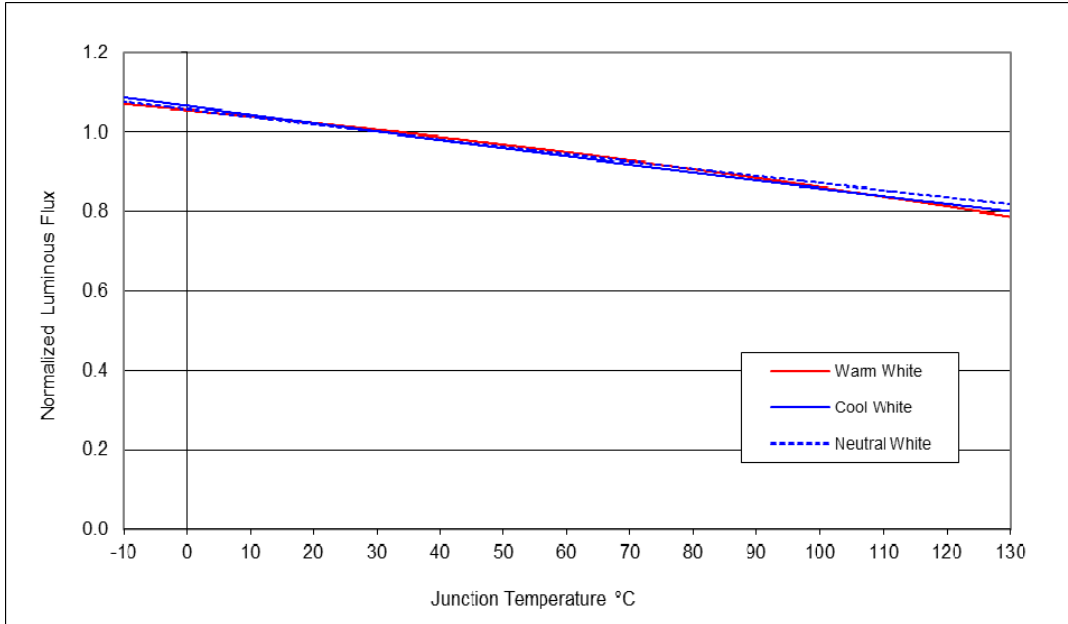

Figure 5: Typical Luminous Flux versus Current
700mA 6V Stars (BXPX-xxxxxxx-B-0x00-SB product series)



Typical Light Output Characteristics vs. Temperature

Figure 6: Typical Flux vs. Junction Temperature



Typical Chromaticity Characteristics vs. Temperature

Figure 7: Typical ccx Shift vs. Junction Temperature

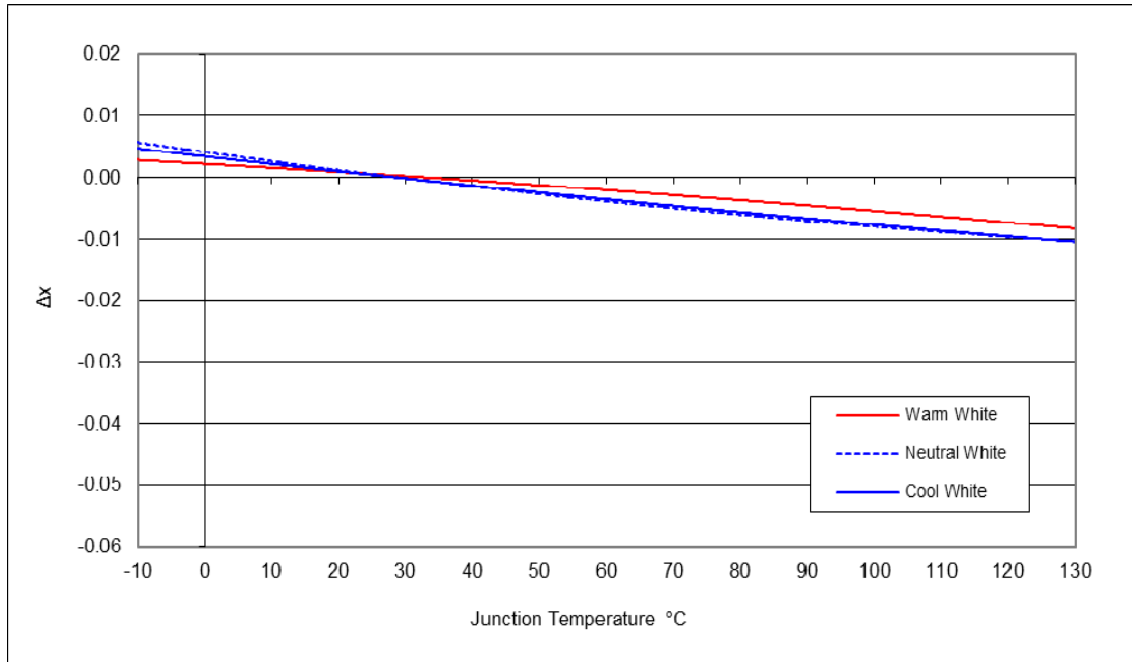

Figure 8: Typical ccy Shift vs. Junction Temperature

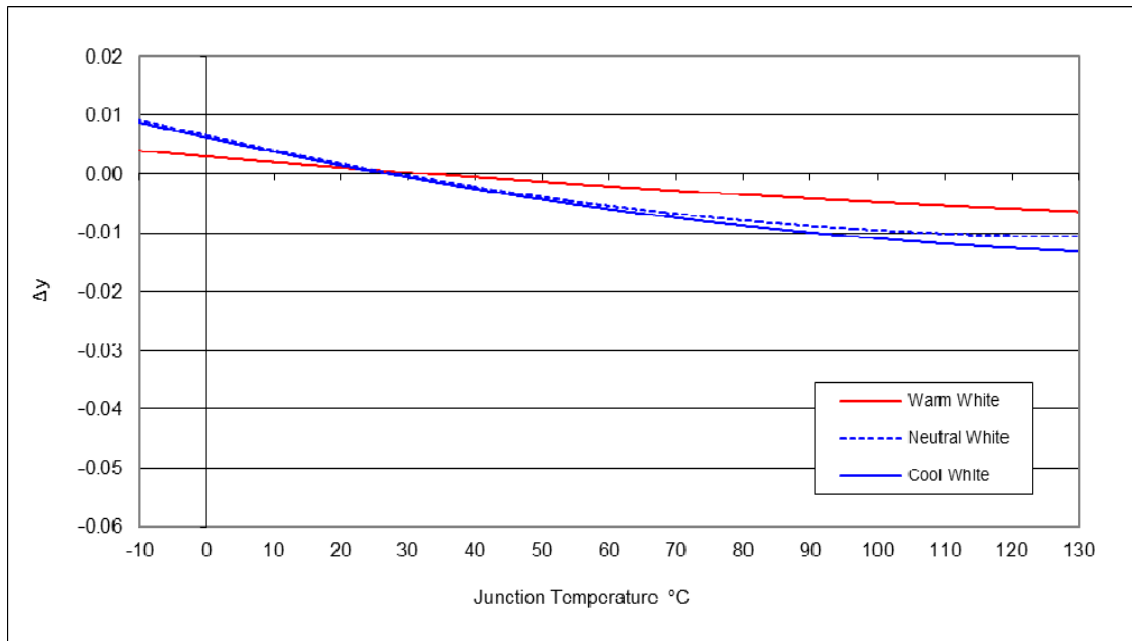

Figure 9: Forward Voltage versus Forward Current
350mA 12V Stars (BXPX-xxxxxxx-A-0x00-SB product series)

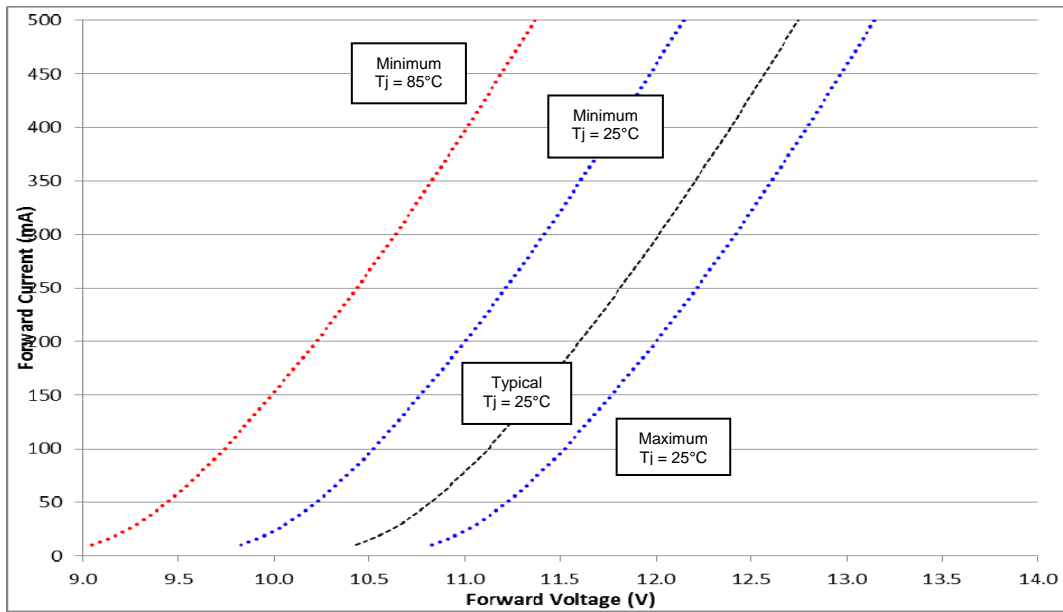
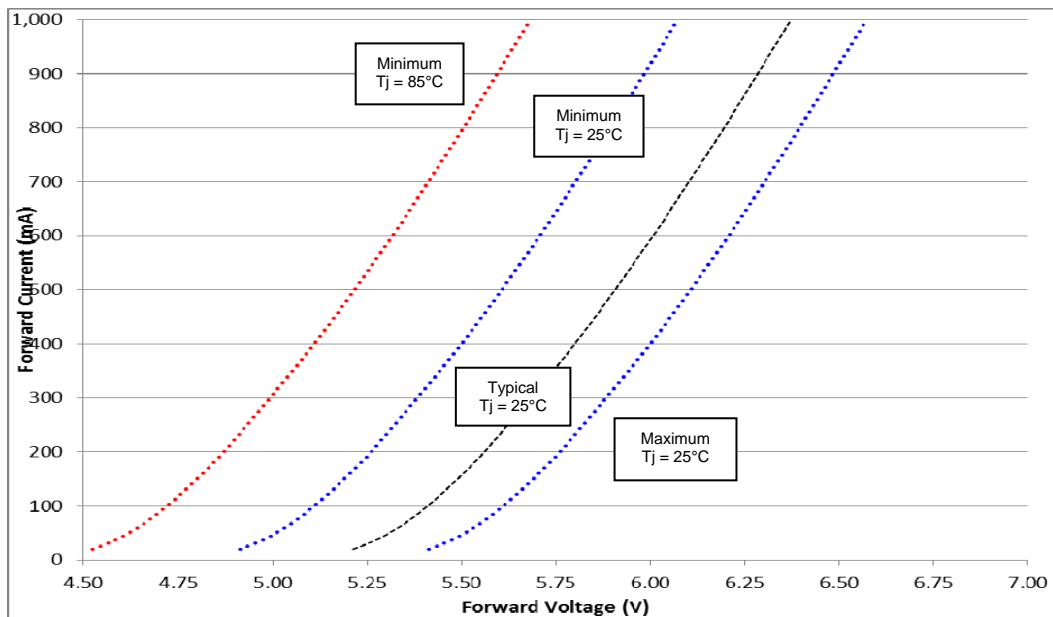

Figure 10: Forward Voltage versus Forward Current
700mA 6V Stars (BXPX-xxxxxxx-B-0x00-SB product series)



Color Binning Information

Figure 11: Graph of 2700K Warm-White Test Bins in x, y Color Space

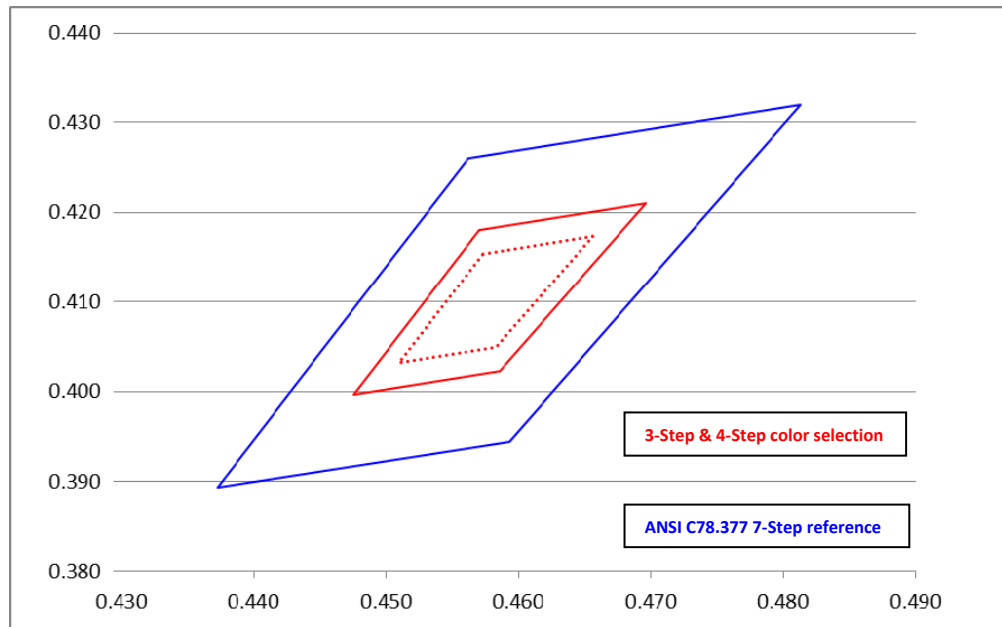

Table 7: 2700K Star Boundary Coordinates

	3 SDCM		4 SDCM	
	x	y	X	y
Center point	0.4578	0.4101	0.4578	0.4101
Top Right	0.4656	0.4174	0.4696	0.4210
Top Left	0.4573	0.4154	0.4570	0.4181
Bottom Left	0.4510	0.4032	0.4476	0.3997
Bottom Right	0.4583	0.4049	0.4586	0.4023

Applicable for part numbers BXPX-27x0400-x-0300-SB and BXPX-27x0400-x-0400-SB.

Notes for Table 7:

1. Bridgelux maintains a tester tolerance of ± 0.003 on x, y color measurements.

Color Binning Information (continued)

Figure 12: Graph of 3000K Warm-White Test Bins in x, y Color Space

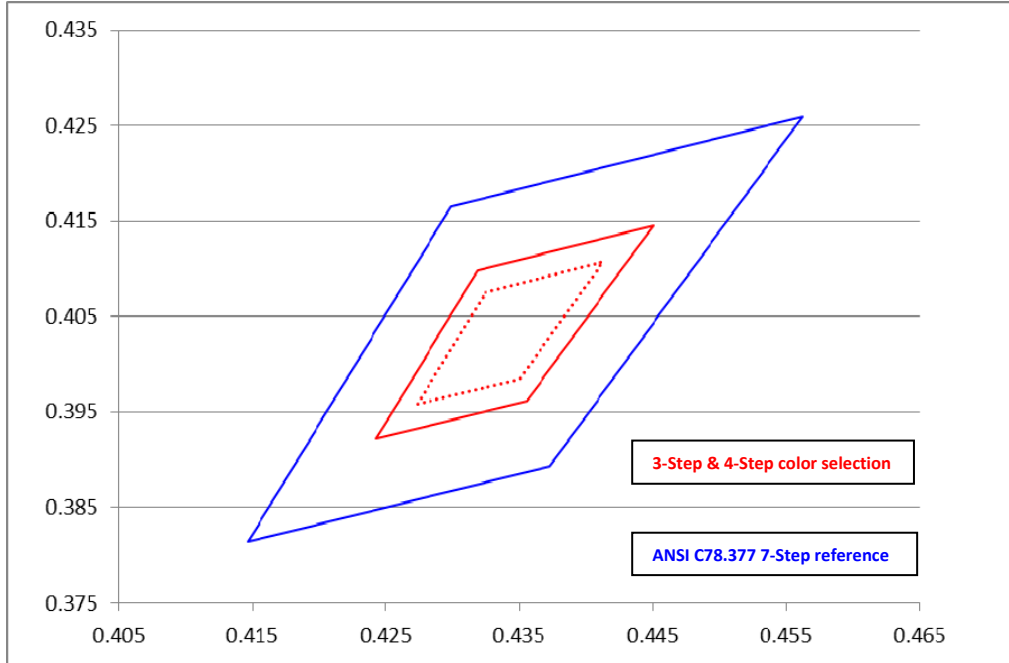

Table 8: 3000K Star Boundary Coordinates

	3 SDCM		4 SDCM	
	x	y	x	y
Center point	0.4338	0.4030	0.4338	0.4030
Top Right	0.4413	0.4107	0.4450	0.4145
Top Left	0.4325	0.4075	0.4319	0.4098
Bottom Left	0.4274	0.3958	0.4243	0.3922
Bottom Right	0.4350	0.3984	0.4356	0.3962

Applicable for part numbers BXPX-30x0400-x-0300-SB and BXPX-30x0400-x-0400-SB.

Notes for Table 8:

1. Bridgelux maintains a tester tolerance of ± 0.003 on x, y color measurements.

Color Binning Information (continued)

Figure 13: Graph of 4000K Neutral-White Test Bins in x, y Color Space

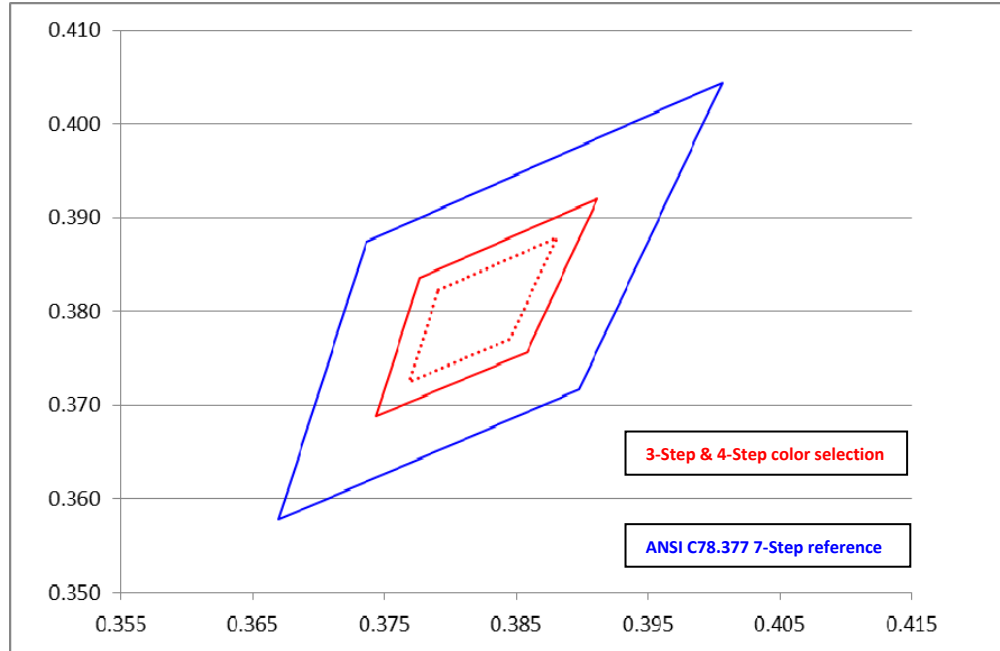

Table 9: 4000K Star Boundary Coordinates

	3 SDCM		4 SDCM	
	x	y	x	y
Center point	0.38180	0.37970	0.38180	0.37970
Top Right	0.38810	0.38790	0.39120	0.39205
Top Left	0.37910	0.38230	0.37770	0.38355
Bottom Left	0.37690	0.37240	0.37440	0.36875
Bottom Right	0.38450	0.37700	0.38580	0.37565

3 SDCM and 4 SDCM applicable for part numbers BXPX-40E0400-x-0300-SB and BXPX-40E0400-x-0400-SB.

4 SDCM applicable for part numbers BXPX-40C0500-x-0400.

Notes for Table 9:

1. Bridgelux maintains a tester tolerance of ± 0.003 on x, y color measurements.

Color Binning Information (continued)

Figure 14: Graph of 5000K Cool-White Test Bins in x, y Color Space

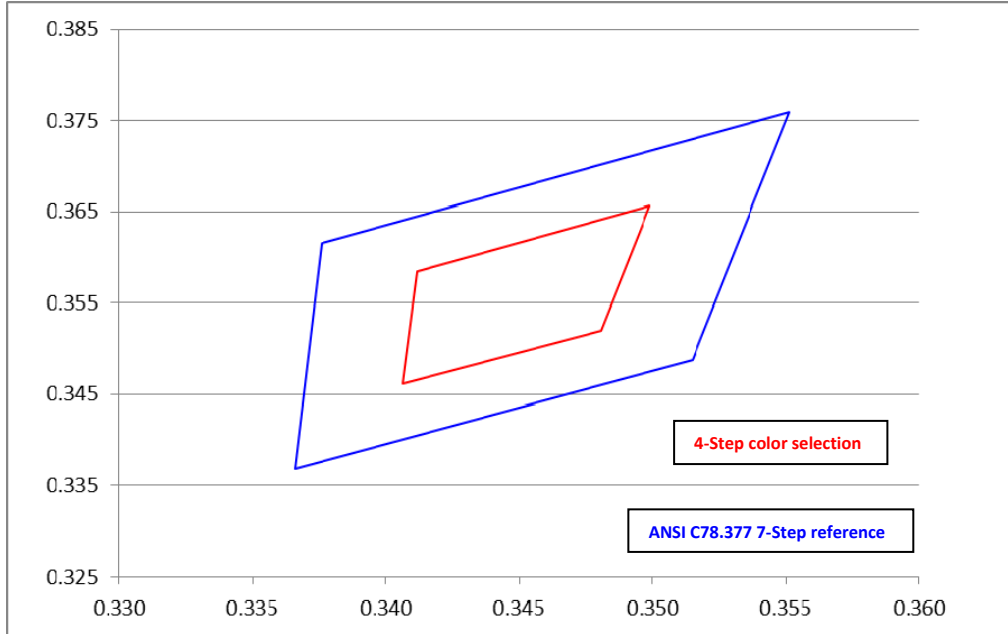

Table 10: 5000K Star Boundary Coordinates

	4 SDCM	
	x	y
Center point	0.34470	0.35530
Top Right	0.34990	0.36565
Top Left	0.34115	0.35845
Bottom Left	0.34065	0.34610
Bottom Right	0.34810	0.35200

Applicable for part numbers BXPX-50C0500-x-0400-SB.

Notes for Table 10:

1. Bridgelux maintains a tester tolerance of ± 0.003 on x, y color measurements.

Color Binning Information (continued)

Figure 15: Graph of 5600K Cool-White Test Bins in x, y Color Space

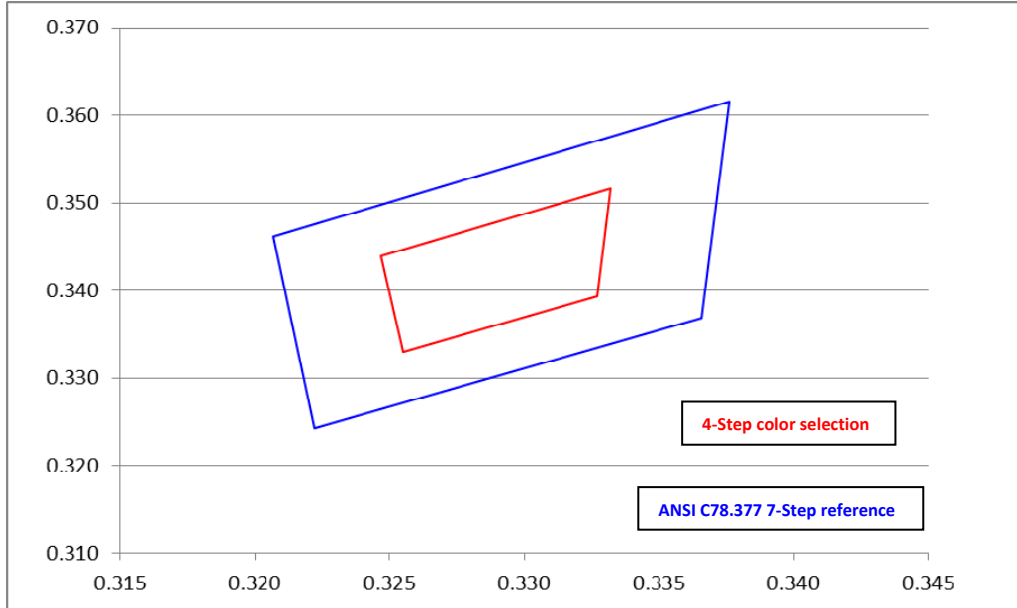

Table 11: 5600K Star Boundary Coordinates

	4 SDCM	
	x	y
Center point	0.3287	0.3417
Top Right	0.3332	0.3517
Top Left	0.3247	0.3440
Bottom Left	0.3255	0.3330
Bottom Right	0.3327	0.3393

Applicable for part numbers BXPX-56C0520-x-0400-SB.

Notes for Table 11:

1. Bridgelux maintains a tester tolerance of ± 0.003 on x, y color measurements.

Product Packaging

Figure 14: Shipping Tube (25 Micro SM4 Star devices per tube).

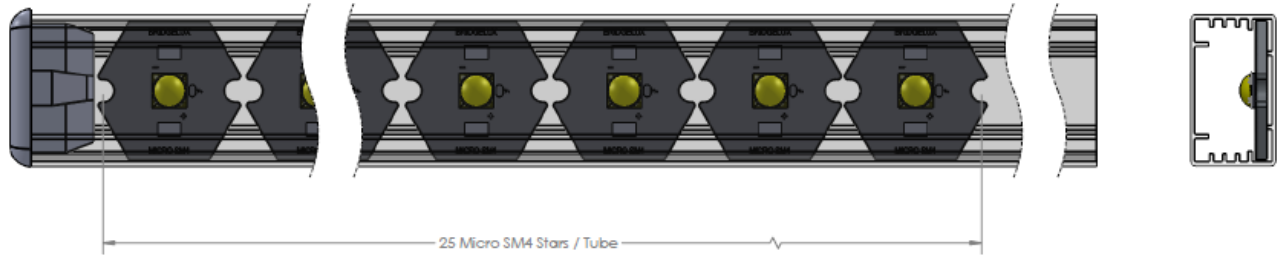

Notes for Figure 14:

1. Drawings are not to scale.
2. Drawing dimensions are in millimeters.
3. Unless otherwise specified, tolerances are $\pm 0.20\text{mm}$.

Product Labeling

Bridgelux Micro SM4 Star products are 100% tested and labeled via laser marking with relevant information on the back side of the metal-core-printed circuit-board (MCPCB). The following format is used for labeling the BXPX product family of Micro SM4 Star products.

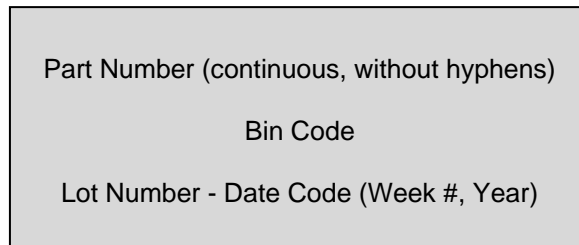

Example: Micro SM4 Star: 3000K, 80 CRI, 1x4 350mA (12V), 4SDCM color selection.

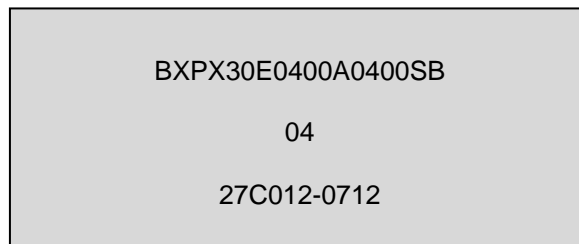

Design Resources

Bridgelux has developed a comprehensive set of application notes and design resources to assist in successfully designing with Bridgelux Micro SM4 Star products. Included below is a list of available resources which can be downloaded from the Bridgelux web site under the Design Resources section. These documents are updated regularly as new information becomes available, including complimentary infrastructure products such as commercially available secondary optics and electronic driver solutions.

Application Notes

- AN20 : Effective Thermal Management of Bridgelux Micro SM4 Series LEDs
- AN21 : Handling and Assembly for Bridgelux Micro SM4 Series LEDs
- AN22 : Electrical Drive Considerations for Bridgelux Micro SM4 Series LEDs
- AN24 : Qualification Testing Summary for Bridgelux Micro SM4 Series LEDs
- AN26 : Optical Considerations for Bridgelux Micro SM4 Series LEDs

3D CAD Models

Three dimensional CAD models, depicting the product outline of the Bridgelux Micro SM4 Star LED, are available in both .igs and .stp formats. These CAD files can be downloaded directly from the Bridgelux web site at www.bridgelux.com.

Optical Source Models

Optical source models and ray trace files are available for the cool-white (5600K) and warm-white (2700K and 3000K) Micro SM4 Stars can be downloaded directly from the Bridgelux website. The list below contains the formats currently available. Please contact your Bridgelux sales representative for assistance if you require a specific format not included in this list

- Photopia
- Light Tools
- Optis
- TracePro
- Zemax
- Radiant Source

About Bridgelux

Bridgelux is a leading developer and manufacturer of technologies and solutions transforming the \$40 billion global lighting industry into a \$100 billion market opportunity. Based in Livermore, California, Bridgelux is a pioneer in solid-state lighting (SSL), expanding the market for light-emitting diode (LED) technologies by driving down the cost of LED lighting systems. Bridgelux's patented light source technology replaces traditional technologies (such as incandescent, halogen, fluorescent and high intensity discharge lighting) with integrated, solid-state lighting solutions that enable lamp and luminaire manufacturers to provide high performance and energy-efficient white light for the rapidly growing interior and exterior lighting markets, including street lights, commercial lighting and consumer applications. Bridgelux is the only vertically integrated LED manufacturer and developer of solid-state light sources that designs its solutions specifically for the lighting industry.

For more information about the company, please visit www.bridgelux.com

© 2012 Bridgelux, Inc. All rights reserved. Product specifications are subject to change without notice.

