

All information is subject to change without notice. Please read bottom notes.

- FEATURES:**(1)6.5" VGA color display with High Luminance (550cd/m²)
 (2)Wide Viewing Angle (Vertical:120° , Horizontal:140°)
 (3)Built in Long Life LEDs (MTBF:70,000 h)
 (Condition; Ta=25°C, PWM=100%(continuous lighting))
 (4)Replaceable structure of LED units

TENTATIVE

RoHS compatible

MECHANICAL SPECIFICATIONS

Item	Specifications
Dimensional Outline (typ.)	153.0 (W) x 121.0 (H) x 10.9 typ(D) mm
Number of Pixels	640 (W) x 480 (H) pixels
Active Area	132.48 (W) x 99.36 (H) mm
Pixel Pitch	0.207 (W) x 0.207 (H)
Weight (approximately)	250 g
Backlight	Sidelight (LEDs)

ABSOLUTE MAXIMUM RATINGS

Item	Min.	Max.	Unit	
Supply Voltage	(V _{DD})	-0.3	4.0	V
	(V _{LED})	0	20.0	V
Input Signal Voltage	(V _{IN})	-0.3	V _{DD} +0.3	V
Operating Temperature *1	-10	70	°C	
Storage Temperature	-20	80	°C	
Storage Humidity (Max. wet bulb temperature = 39°C)	10	90	%(RH)	

*1 : Only operation is guaranteed at Operating Temperature. Display quality is evaluated at +25°C.

ELECTRICAL SPECIFICATION (Ta=25°C) (RECOMMENDED OPERATION CONDITION)

Item	Min.	Typ.	Max.	Unit	Remarks	
Supply Voltage	(V _{DD})	3.0	3.3	3.6	V	
	(V _{LED})	10.8	12.0	13.2	V	
High Level Input Voltage	(V _{IH})	0.7 V _{DD}	---	V _{DD}	V	
Low Level Input Voltage	(V _{IL})	0	---	0.3 V _{DD}	V	
Backlight ON/OFF signal	(V _{ON/OFF})	2.0	---	V _{DD}	V	ON
		0	---	0.8	V	OFF
Luminance control signal	(V _{PWM})	0	---	3.3	V	
Current Consumption	(I _{DD}) *2	---	120	---	mA	
	(I _{LED})	---	260	---	mA	PWM=100%
Power Consumption *2	---	3.5	---	W	PWM=100%	

*2 : 8 color bars pattern

OPTICAL SPECIFICATION (Ta=25°C)

Item	Min.	Typ.	Max.	Unit	Remarks
Contrast Ratio	(CR)	250	500	---	
Viewing Angle (CR ≥ 10)	(Upper+Lower)	---	120	---	°
	(Left+Right)	---	140	---	°
Response Time	(T _{ON})	---	15	---	ms
	(T _{OFF})	---	25	---	ms
Luminance	(L)	380	550	---	cd/m ² PWM=100%
LED Life Time (MTBF) *3 *4			70,000		h PWM=100%

*3 : Conditions ; Ta=25°C, continuous lighting

*4 : Definitions of failure ; 1) Lcd luminance becomes half of the minimum value. 2) LED doesn't light normally.

*The information contained herein is presented only as a guide for the applications of our products. No responsibility is assumed by Toshiba Matsushita Display Technology or other rights of the third parties which may result from its use. No license is granted by implication or otherwise under any patent or patent rights of Toshiba Matsushita Display Technology or others.

*The information contained herein may be changed without prior notice. It is therefore advisable to contact Toshiba Matsushita Display Technology before proceeding with the design of equipment incorporating this product.

DIMENSIONAL OUTLINE

<Front side>

TENTATIVE

Unit : mm

Standard tolerance : +/-0.5

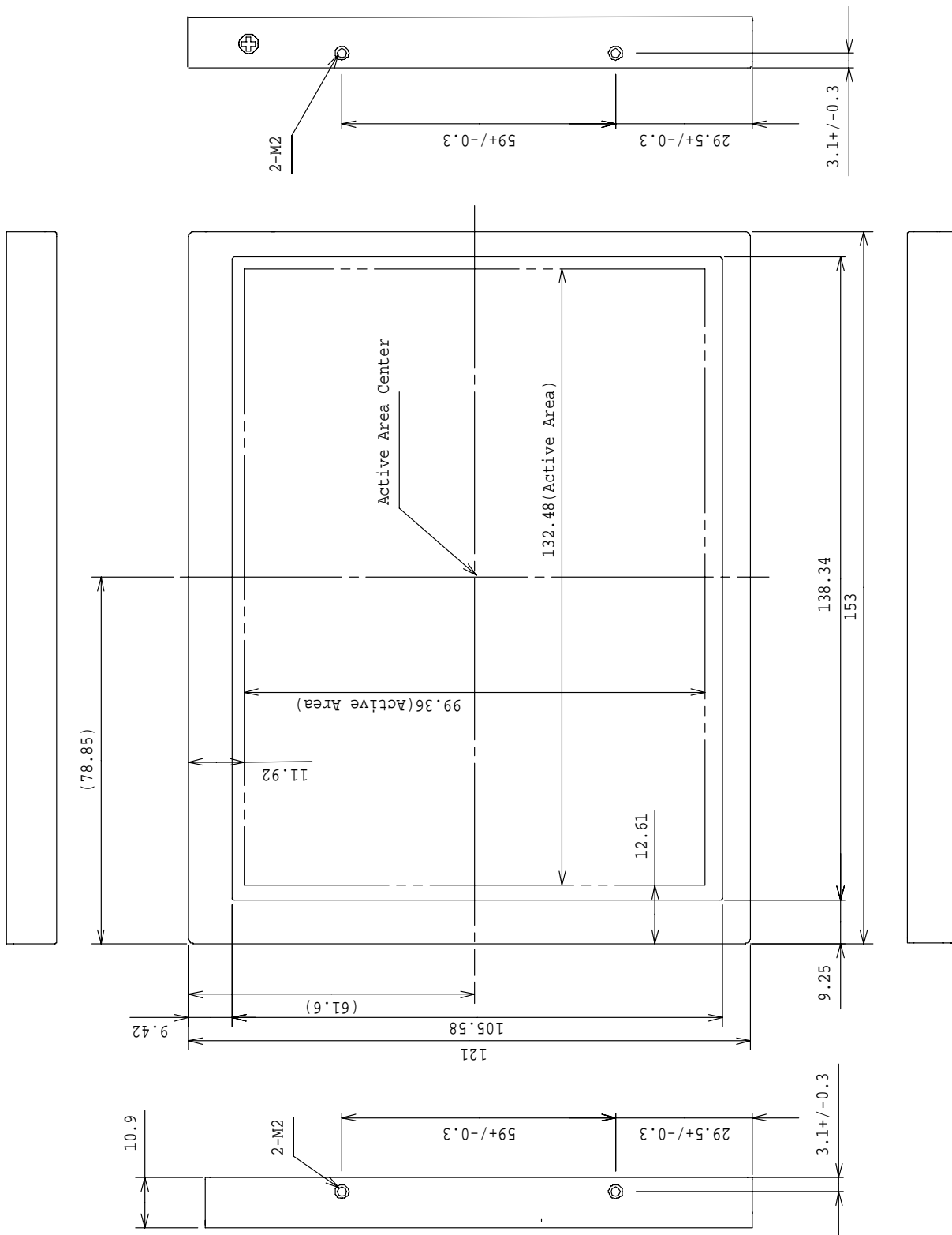

TENTATIVE

Unit : mm

Standard tolerance : +/-0.5

<Rear side>

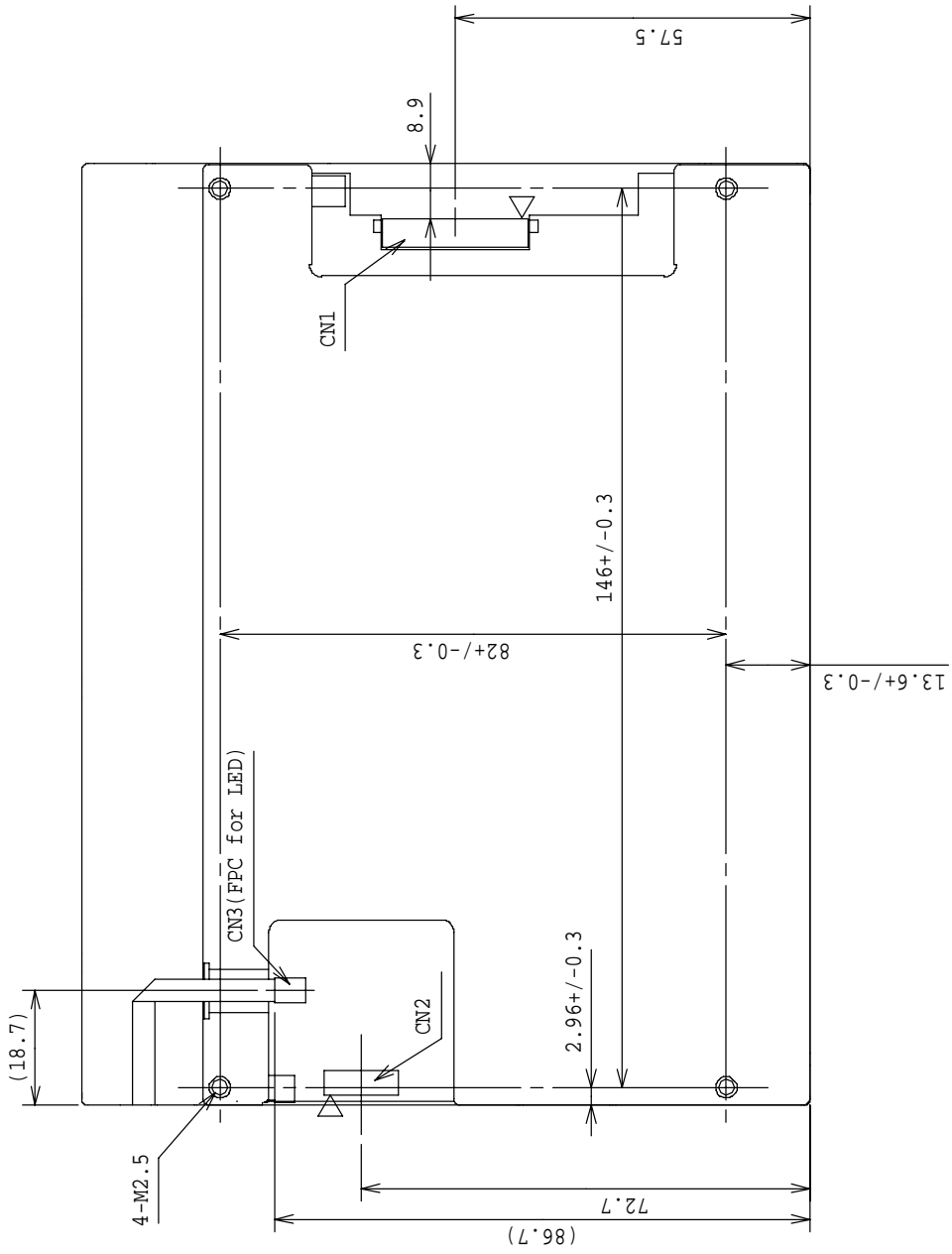

BLOCK DIAGRAM

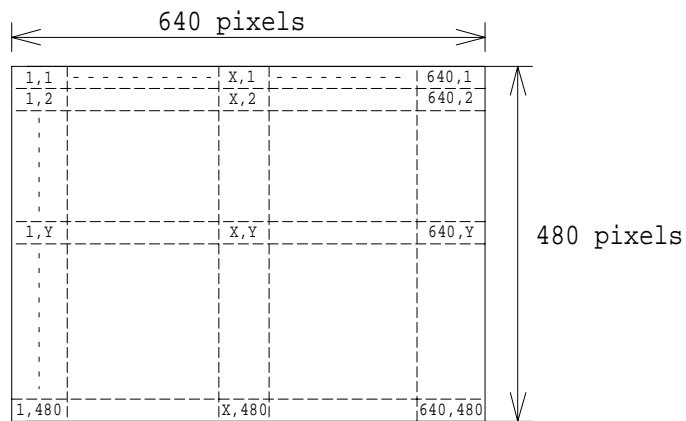
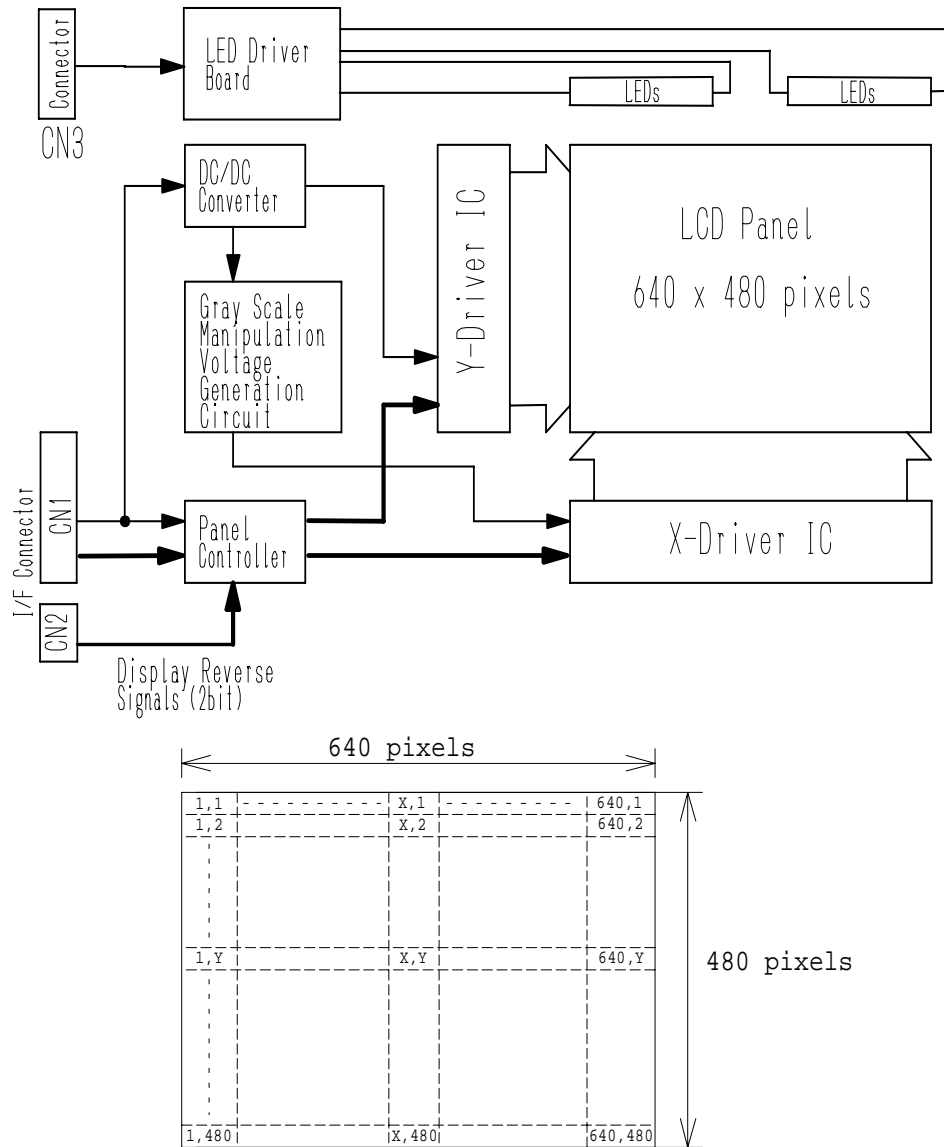

SEQUENCE OF POWER SUPPLIES AND SIGNALS

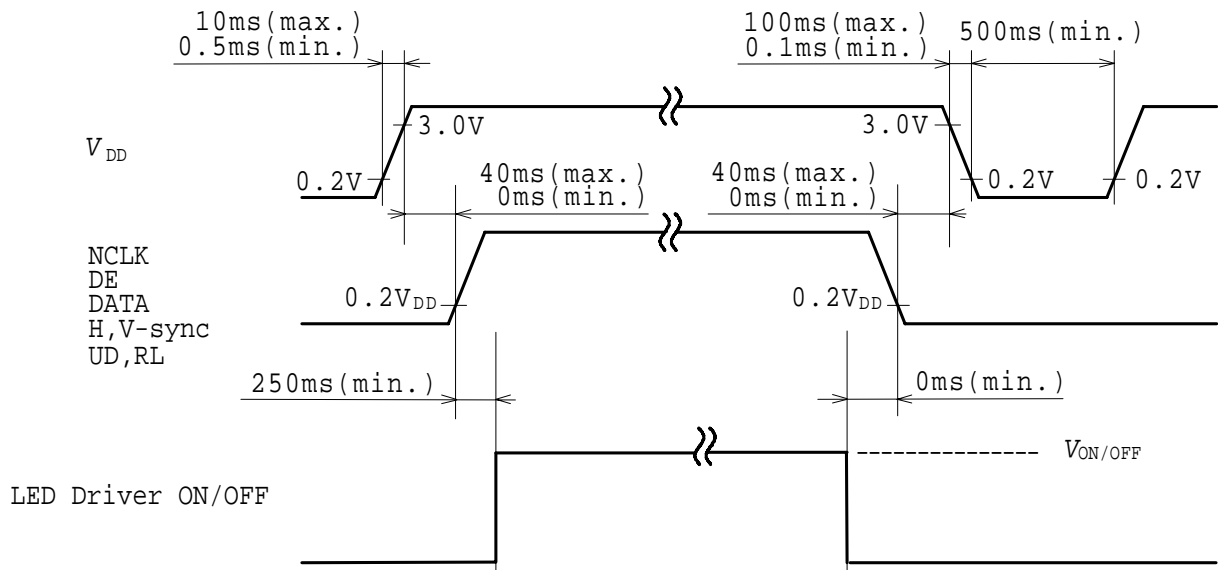

Note) When turn VDD on and turn it off, the form of voltage should be input with no ripple signal.

TIMING CHART

<H-Sync/V-Sync+DE Mode>

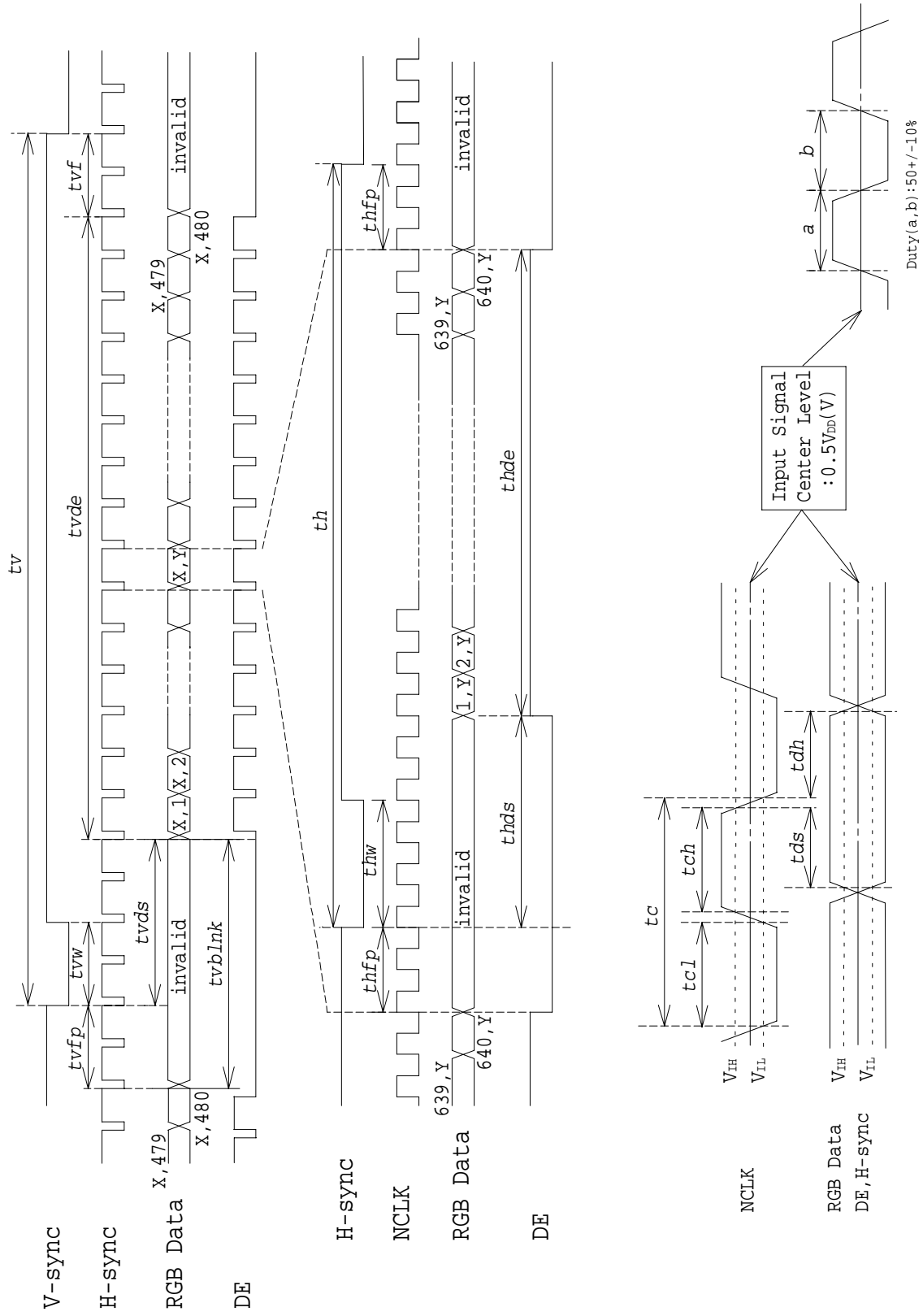

<DE-Only Mode>

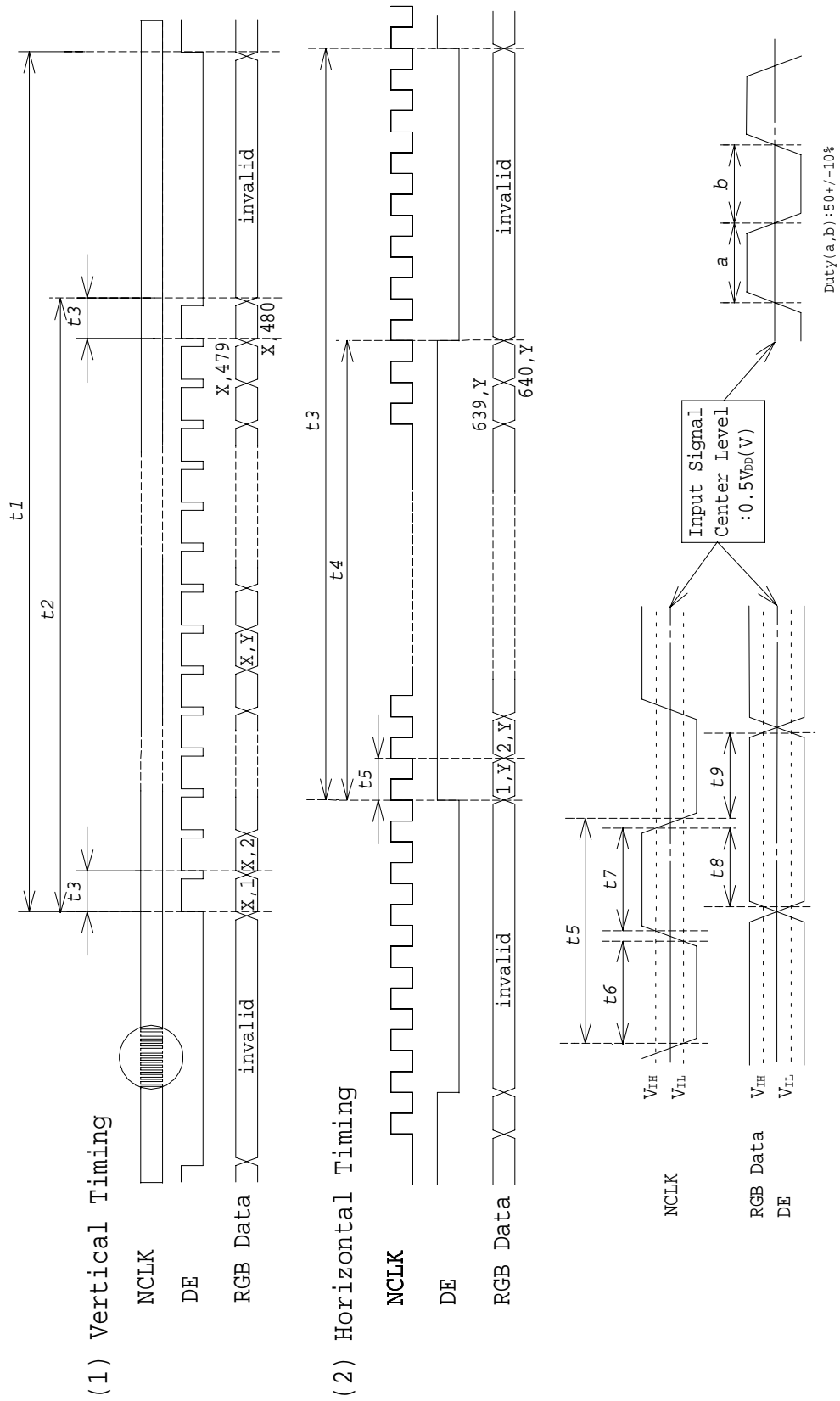

TIMING SPECIFICATION ^{1) 2) 3) 4) 5) 6)}

<H-Sync/V-Sync+DE Mode>

Item	Symbol	min.	typ.	Max.	unit
Frame Period	<i>tv</i>	500	525	550	<i>th</i>
		---	16.67	17.85	ms
Vertical blanking Term	<i>tvblnk</i>	20	45	70	<i>th</i>
V-sync Pulse Width	<i>tvw</i>	2	---	---	<i>th</i>
Vertical Front Porch	<i>tvfp</i>	2	---	---	<i>th</i>
Vertical Data Sync Period	<i>tvds</i>	6	---	---	<i>th</i>
Vertical Display Term	<i>tvde</i>	480	480	480	<i>th</i>
Horizontal Period	<i>th</i>	740	800	860	<i>tc</i>
		31.5	31.75	---	us
H-sync Pulse Width	<i>thw</i>	8	160	---	<i>tc</i>
Horizontal Front Porch	<i>thfp</i>	8	---	---	<i>tc</i>
Horizontal Data Sync Period	<i>thds</i>	8	---	---	<i>tc</i>
Horizontal Display Term	<i>thde</i>	640	640	640	<i>tc</i>
Clock Period	<i>tc</i>	35.0	39.7	40.0	ns
Clock "L" Time	<i>tcl</i>	10.0	---	---	ns
Clock "H" Time	<i>tch</i>	10.0	---	---	ns
Data Setup Time	<i>tds</i>	5.0	---	---	ns
Data Hold Time	<i>tdh</i>	10.0	---	---	ns

<DE-Only Mode>

Item	Symbol	min.	typ.	Max.	unit
Frame Period	<i>t1</i>	500 x t3	525 x t3	550 x t3	---
		---	16.67	17.85	ms
Vertical Display Term	<i>t2</i>	480 x t3	480 x t3	480 x t3	---
One Line Scanning Term	<i>t3</i>	740 x t5	800 x t5	860 x t5	---
		31.5	31.75	---	us
Horizontal Display Term	<i>t4</i>	640 x t5	640 x t5	640 x t5	---
Clock Period	<i>t5</i>	35.0	39.7	40.0	ns
Clock "L" Time	<i>t6</i>	10.0	---	---	ns
Clock "H" Time	<i>t7</i>	10.0	---	---	ns
Data Setup Time	<i>t8</i>	5.0	---	---	ns
Data Hold Time	<i>t9</i>	10.0	---	---	ns

Note 1) If NCLK is fixed to "H" or "L" level for certain period while DE is supplied, the panel may be damaged.

Note 2) If DE is fixed to "H" or "L" level for certain period while NCLK is supplied, the panel displays black with some flicker.

Note 3) Please adjust LCD operating signal timing and LED PWM frequency, to optimize the display quality.

There is a possibility that flicker is observed by the interference of LCD operating signal timing and PWM condition (especially driving frequency), even if the condition satisfies above timing specifications and recommended operating conditions.

Note 4) Do not make *tv(t1)*, *th(t2)* and *tvds(t3)* fluctuate.

Note 5) In case of using the long frame period, the deterioration of display quality, noise etc. may be occurred.

Note 6) NCLK count of each Horizontal Scanning Time should be always the same.

V-Blanking period should be "*n*" X "Horizontal Scanning Time". (*n*: integer)

Frame period should be always the same.

CONNECTOR PIN ASSIGNMENT FOR INTERFACE

CN1 INPUT SIGNAL

Connector : DF19L-30P-1H (56)/ HIROSE ELECTRIC CO., LTD.

Mating Connector : DF19G-30S-1C(Plug), DF19-2830SCFA(Crimp contact)

Terminal No.	Symbol	Function
1	GND	
2	NCLK	SAMPLING CLOCK
3	H-Sync	HORIZONTAL SYNC.
4	V-Sync	VERTICAL SYNC.
5	GND	
6	R0 ¹⁾	RED DISPLAY DATA (LSB)
7	R1 ¹⁾	RED DISPLAY DATA
8	R2 ¹⁾	RED DISPLAY DATA
9	R3 ¹⁾	RED DISPLAY DATA
10	R4 ¹⁾	RED DISPLAY DATA
11	R5 ¹⁾	RED DISPLAY DATA (MSB)
12	GND	
13	G0 ¹⁾	GREEN DISPLAY DATA (LSB)
14	G1 ¹⁾	GREEN DISPLAY DATA
15	G2 ¹⁾	GREEN DISPLAY DATA
16	G3 ¹⁾	GREEN DISPLAY DATA
17	G4 ¹⁾	GREEN DISPLAY DATA
18	G5 ¹⁾	GREEN DISPLAY DATA (MSB)
19	GND	
20	B0 ¹⁾	BLUE DISPLAY DATA (LSB)
21	B1 ¹⁾	BLUE DISPLAY DATA
22	B2 ¹⁾	BLUE DISPLAY DATA
23	B3 ¹⁾	BLUE DISPLAY DATA
24	B4 ¹⁾	BLUE DISPLAY DATA
25	B5 ¹⁾	BLUE DISPLAY DATA (MSB)
26	DE	DATA ENABLE
27	GND	
28	VDD	+3.3V POWER SUPPLY
29	VDD	+3.3V POWER SUPPLY
30	GND	

Note 1) See next page.

CN2 INPUT SIGNAL

Connector : DF14H-2P-1.25H(56) / HIROSE ELECTRIC CO., LTD.

Mating Connector : DF14-2S-1.25C(Socket), DF14-2628SCFA(Contact)

Terminal No.	Symbol	Function
1	U D	VERTICAL REVERSE("L" level or Open ; normal, "H" level ; reverse)
2	R L	HORIZONTAL REVERSE ("L" level or Open ; normal, "H" level ; reverse)

CN3 LED INPUT SIGNAL

Connector : 53261-0671 / MOLEX Inc.

Mating Connector : 51021-0600 / MOLEX Inc.

Terminal No.	Symbol	Function
1	VLED	Power Supply : +12V
2	VLED	Power Supply : +12V
3	VSS	GND
4	VSS	GND
5	ON/OFF	"H(+3.3V)":ON, "L(GND or Open)":OFF
6	PWM	1-100%(200Hz)

256k (k=1024) COLORS COMBINATION TABLE

	Display	R5 R4 R3 R2 R1 R0	G5 G4 G3 G2 G1 G0	B5 B4 B3 B2 B1 B0	Gray Scale Level
Basic Color	Black	L L L L L L	L L L L L L	L L L L L L	---
	Blue	L L L L L L	L L L L L L	H H H H H H	---
	Green	L L L L L L	H H H H H H	L L L L L L	---
	Light Blue	L L L L L L	H H H H H H	H H H H H H	---
	Red	H H H H H H	L L L L L L	L L L L L L	---
	Purple	H H H H H H	L L L L L L	H H H H H H	---
	Yellow	H H H H H H	H H H H H H	L L L L L L	---
	White	H H H H H H	H H H H H H	H H H H H H	---
Gray Scale of Red	Black	L L L L L L	L L L L L L	L L L L L L	L 0
	Dark ↑ ↓ Light	L L L L L H	L L L L L L	L L L L L L	L 1
		L L L L H L	L L L L L L	L L L L L L	L 2
		:	:	:	L3... L60
	Light	H H H H L H	L L L L L L	L L L L L L	L61
		H H H H H L	L L L L L L	L L L L L L	L62
Red	H H H H H H	L L L L L L	L L L L L L	Red L63	
Gray Scale of Green	Black	L L L L L L	L L L L L L	L L L L L L	L 0
	Dark ↑ ↓ Light	L L L L L L	L L L L L H	L L L L L L	L 1
		L L L L L L	L L L L H L	L L L L L L	L 2
		:	:	:	L3... L60
	Light	L L L L L L	H H H H L H	L L L L L L	L61
		L L L L L L	H H H H H L	L L L L L L	L62
Green	L L L L L L	H H H H H H	L L L L L L	Green L63	
Gray Scale of Blue	Black	L L L L L L	L L L L L L	L L L L L L	L 0
	Dark ↑ ↓ Light	L L L L L L	L L L L L L	L L L L L H	L 1
		L L L L L L	L L L L L L	L L L L H L	L 2
		:	:	:	L3... L60
	Light	L L L L L L	L L L L L L	H H H H L H	L61
		L L L L L L	L L L L L L	H H H H H L	L62
Blue	L L L L L L	L L L L L L	H H H H H H	Blue L63	
Gray Scale of White & Black	Black	L L L L L L	L L L L L L	L L L L L L	L 0
	Dark ↑ ↓ Light	L L L L L H	L L L L L H	L L L L L H	L 1
		L L L L H L	L L L L H L	L L L L H L	L 2
		:	:	:	L3... L60
	Light	H H H H L H	H H H H L H	H H H H L H	L61
		H H H H H L	H H H H H L	H H H H H L	L62
White	H H H H H H	H H H H H H	H H H H H H	White L63	

**FOR SAFETY**

LCD module is generally designed with precise parts to achieve light weighted thin mechanical dimensions.

In using our Modules, make certain that you fully understand and put into practice the warnings and safety precautions detailed in Engineering Information No.EE-N001,"CAUTIONS AND INSTRUCTIONS FOR TOSHIBA LCD MODULES".

Refer to individual specifications and TECHNICAL DATA sheets (hereinafter called "TD") for more detailed technical information.

1) SPECIAL PURPOSES

A) Toshiba Matsushita Display Technology's Standard LCD Modules have not been customized for operation in extreme environments or for use in applications where performance failures could be life-threatening or otherwise catastrophic.

B) Since Toshiba Matsushita Display Technology's Standard LCD Modules have not been designed for operation in extreme environments, they must never be used in devices that will be exposed to abnormally high levels of vibration or shock which exceed Toshiba Matsushita Display Technology's published specification limits.

C) In addition, since Toshiba Matsushita Display Technology Standard LCD Modules have not been designed for use in applications where performance failures could be life-threatening or catastrophic, they must never be installed in aircraft navigation control systems (such as, but not limited to Traffic Collision Avoidance System and Air Traffic Indicator), in military defense or weapons systems, in critical industrial process-control systems (e.g., those involved in the production of nuclear energy), or in critical medical device or patient life-support systems.

2) DISASSEMBLING OR MODIFICATION

DO NOT DISASSEMBLE OR MODIFY the module. It may damage sensitive parts inside LCD module, and may cause scratches or dust on the display.

Toshiba Matsushita Display Technology does not warrant the module, if customer disassembled or modified it.

3) BREAKAGE OF LCD PANEL

DO NOT INGEST liquid crystal material, DO NOT INHALE this material, and DO NOT CONTACT the material with skin, if LCD panel is broken and liquid crystal material spills out.

If liquid crystal material comes into mouth or eyes, rinse mouth or eyes out with water immediately.

If this material contact with skin or cloths, wash it off immediately with alcohol and rinse thoroughly with water.

4) GLASS OF LCD PANEL

BE CAREFUL WITH CHIPS OF GLASS that may cause injuring fingers or skin, when the glass is broken.

5) ELECTRIC SHOCK

DISCONNECT POWER SUPPLY before handling LCD module.

DO NOT TOUCH the parts inside LCD module and the fluorescent lamp's connector or cables in order to prevent electric shock, because high voltage is supplied to these parts from the inverter unit while power supply is turned on.

6) ABSOLUTE MAXIMUM RATINGS AND POWER PROTECTION CIRCUIT

DO NOT EXCEED the absolute maximum rating values under the worst probable conditions caused by the supply voltage variation, input voltage variation, variation in parts' constants, environmental temperature, etc., otherwise LCD module may be damaged.

Employ protection circuit for power supply, whenever the specification or TD specifies it.

Suitable protection circuit should be applied for each system design.

7) RECOMMENDED OPERATION CONDITIONS

The performance and quality of the LCD panel are warranted only when the LCD panel is used within "the recommended operation conditions". Toshiba Matsushita Display Technology Co., Ltd. never warrants the performance and quality of the LCD panel when you use the LCD panel over "the recommended operation conditions", although within "the absolute maximum rating".

To use the LCD panel over "the recommended operation conditions" may have bad influence on the characteristics and reliability of the LCD panel and may shorten the life of the LCD panel.

Therefore, when designing the whole set, not to be over "the recommended operation conditions", you should fully take care of supply voltage change, characteristic of connection parts, surge of input-and-output line, and surrounding temperature.

8) DISPOSAL

When dispose LCD module, obey to the applicable environmental regulations.