

FOD8321

2.5A Output Current, Gate Drive Optocoupler in Optoplanar® Wide Body SOP 5-Pin

Features

- Fairchild's Optoplanar® packaging technology provides reliable and high voltage insulation with greater than 8mm creepage and clearance distance, and 0.5mm internal insulation distance while still offering a compact footprint
- 2.5A output current driving capability for medium power IGBT/MOSFET
 - Use of P-Channel MOSFETs at output stage enables output voltage swing close to the supply rail
- 20kV/μs Minimum Common Mode Rejection
- Wide Supply Voltage range from 15V to 30V
- Fast Switching Speed over full operating temperature range
 - 500ns max. propagation delay
 - 300ns max. pulse width distortion
- UnderVoltage LockOut (UVLO) with hysteresis
- Extended industrial temperature range, -40 to 100°C temperature range
- Safety and regulatory approvals
 - UL1577, 5,000V_{RMS} for 1 min.
 - DIN EN/IEC60747-5-5, 1,414V peak working insulation voltage

Applications

- AC and brushless DC motor drives
- Industrial inverter
- Uninterruptible power supply
- Induction heating
- Isolated IGBT/Power MOSFET gate drive

Related Resources

- FOD3120, High Noise Immunity, 2.5A Output Current, Gate Drive Optocoupler Datasheet

Description

The FOD8321 is a 2.5A Output Current Gate Drive Optocoupler, capable of driving medium power IGBT/MOSFETs. It is ideally suited for fast switching driving of power IGBT and MOSFETs used in motor control inverter applications, and high performance power systems.

It utilizes Fairchild's coplanar packaging technology, Optoplanar®, and optimized IC design to achieve reliably high insulation voltage and high noise immunity.

It consists of a aluminum gallium arsenide (AlGaAs) light emitting diode optically coupled to an integrated circuit with a high-speed driver for push-pull MOSFET output stage. The device is housed in a wide body 5-pin small outline plastic package.

Functional Schematic

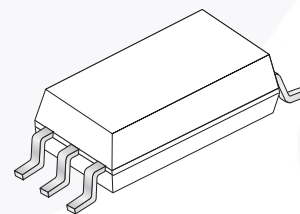
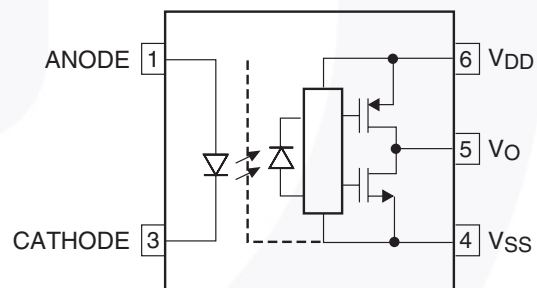

Truth Table

LED	$V_{DD}-V_{SS}$ “Positive Going” (Turn-on)	$V_{DD}-V_{SS}$ “Positive Going” (Turn-off)	V_O
Off	0V to 30V	0V to 30V	Low
On	0V to 11.5V	0V to 10V	Low
On	11.5V to 14.5V	10V to 13V	Transition
On	14.5V to 30V	13V to 30V	High

Pin Definitions

Pin #	Name	Description
1	Anode	LED Anode
3	Cathode	LED Cathode
4	V_{SS}	Negative Supply Voltage
5	V_O	Output Voltage
6	V_{DD}	Positive Supply voltage

Pin Configuration

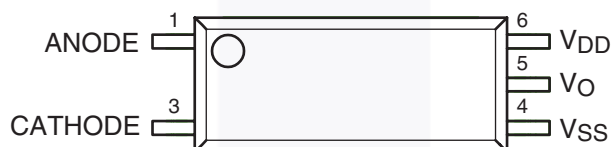

Safety and Insulation Ratings

As per DIN EN/IEC60747-5-5. This optocoupler is suitable for “safe electrical insulation” only within the safety limit data. Compliance with the safety ratings shall be ensured by means of protective circuits.

Symbol	Parameter	Min.	Typ.	Max.	Unit
	Installation Classifications per DIN VDE 0110/1.89 Table 1				
	For Rated Mains Voltage < 150Vrms		I-IV		
	For Rated Mains Voltage < 300Vrms		I-IV		
	For Rated Mains Voltage < 450Vrms		I-III		
	For Rated Mains Voltage < 600Vrms		I-III		
	Climatic Classification		40/100/21		
	Pollution Degree (DIN VDE 0110/1.89)		2		
CTI	Comparative Tracking Index	175			
V_{PR}	Input to Output Test Voltage, Method b, $V_{IORM} \times 1.875 = V_{PR}$, 100% Production Test with $t_m = 1$ sec., Partial Discharge < 5pC	2651			
	Input to Output Test Voltage, Method a, $V_{IORM} \times 1.5 = V_{PR}$, Type and Sample Test with $t_m = 60$ sec., Partial Discharge < 5 pC	2121			
V_{IORM}	Max Working Insulation Voltage	1,414			V_{peak}
V_{IOTM}	Highest Allowable Over Voltage	6000			V_{peak}
	External Creepage	8.0			mm
	External Clearance	8.0			mm
	Insulation Thickness	0.5			mm
	Safety Limit Values – Maximum Values Allowed in the Event of a Failure				
T_S	Case Temperature	150			°C
$I_{S,INPUT}$	Input Current	200			mA
$P_{S,OUTPUT}$	Output Power	600			mW
R_{IO}	Insulation Resistance at T_S , $V_{IO} = 500V$	10^9			Ω

Absolute Maximum Ratings ($T_A = 25^\circ\text{C}$ unless otherwise specified)

Stresses exceeding the absolute maximum ratings may damage the device. The device may not function or be operable above the recommended operating conditions and stressing the parts to these levels is not recommended. In addition, extended exposure to stresses above the recommended operating conditions may affect device reliability. The absolute maximum ratings are stress ratings only.

Symbol	Parameter	Value	Units
T_{STG}	Storage Temperature	-40 to +125	$^\circ\text{C}$
T_{OPR}	Operating Temperature	-40 to +100	$^\circ\text{C}$
T_J	Junction Temperature	-40 to +125	$^\circ\text{C}$
T_{SOL}	Lead Solder Temperature (Refer to Reflow Temperature Profile)	260 for 10 sec	$^\circ\text{C}$
$I_{F(AVG)}$	Average Input Current	25	mA
F	Operating Frequency	50	kHz
V_R	Reverse Input Voltage	5.0	V
$I_{O(PEAK)}$	Peak Output Current ⁽¹⁾	3.0	A
V_{DD}	Supply Voltage	0 to 35	V
$V_{O(PEAK)}$	Peak Output Voltage	0 to V_{DD}	V
$t_{R(IN)}, t_{F(IN)}$	Input Signal Rise and Fall Time	500	ns
PD_I	Input Power Dissipation ⁽²⁾⁽⁴⁾	45	mW
PD_O	Output Power Dissipation ⁽³⁾⁽⁴⁾	500	mW

Notes:

1. Maximum pulse width = 10 μs , maximum duty cycle = 0.2%.
2. No derating required across operating temperature range.
3. Derate linearly from 25 $^\circ\text{C}$ at a rate of 5.2mW/ $^\circ\text{C}$
4. Functional operation under these conditions is not implied. Permanent damage may occur if the device is subjected to conditions outside these ratings.

Recommended Operating Conditions

The Recommended Operating Conditions table defines the conditions for actual device operation. Recommended operating conditions are specified to ensure optimal performance to the datasheet specifications. Fairchild does not recommend exceeding them or designing to absolute maximum ratings.

Symbol	Parameter	Min.	Max.	Unit
T_A	Ambient Operating Temperature	-40	100	$^\circ\text{C}$
$V_{DD} - V_{SS}$	Supply Voltage	16	30	V
$I_{F(ON)}$	Input Current (ON)	10	16	mA
$V_{F(OFF)}$	Input Voltage (OFF)	0	0.8	V

Isolation Characteristics

Apply over all recommended conditions, typical value is measured at $T_A = 25^\circ\text{C}$

Symbol	Parameter	Conditions	Min.	Typ.	Max.	Units
V_{ISO}	Input-Output Isolation Voltage	$T_A = 25^\circ\text{C}$, R.H. < 50%, $t = 1.0\text{min}$, $I_{I-O} \leq 20\mu\text{A}$, 50Hz ⁽⁵⁾⁽⁶⁾	5,000			V_{RMS}
R_{ISO}	Isolation Resistance	$V_{I-O} = 500\text{V}^{(5)}$		10^{11}		Ω
C_{ISO}	Isolation Capacitance	$V_{I-O} = 0\text{V}$, Freq = 1.0MHz ⁽⁶⁾		1		pF

Notes:

- Device is considered a two terminal device: Pins 1 and 3 are shorted together and Pins 4, 5 and 6 are shorted together.
- 5,000 VAC_{RMS} for 1 minute duration is equivalent to 6,000 VAC_{RMS} for 1 second duration.

Electrical Characteristics

Apply over all recommended conditions, typical value is measured at $V_{DD} = 30\text{V}$, $V_{SS} = \text{Ground}$, $T_A = 25^\circ\text{C}$ unless otherwise specified.

Symbol	Parameter	Conditions	Min.	Typ.	Max.	Units	Figure
V_F	Input Forward Voltage	$I_F = 10\text{mA}$	1.1	1.5	1.8	V	16
$\Delta(V_F / T_A)$	Temperature Coefficient of Forward Voltage			-1.8		mV/°C	
BV_R	Input Reverse Breakdown Voltage	$I_R = 10\mu\text{A}$	5			V	
C_{IN}	Input Capacitance	$f = 1\text{MHz}$, $V_F = 0\text{V}$		60		pF	
I_{OH}	High Level Output Current ⁽¹⁾	$V_{OH} = V_{DD} - 3\text{V}$	1.0	2.0	2.5	A	1, 3
		$V_{OH} = V_{DD} - 6\text{V}$	2.0		2.5	A	1, 3, 19
I_{OL}	Low Level Output Current ⁽¹⁾	$V_{OL} = V_{SS} + 3\text{V}$	1.0	2.0	2.5	A	4, 6
		$V_{OL} = V_{SS} + 6\text{V}$	2.0		2.5	A	4, 6, 18
V_{OH}	High Level Output Voltage ⁽⁷⁾⁽⁸⁾	$I_F = 10\text{mA}$, $I_O = -2.5\text{A}$	$V_{DD} - 6.25$	$V_{DD} - 2.5$		V	1
		$I_F = 10\text{mA}$, $I_O = -100\text{mA}$	$V_{DD} - 0.5$	$V_{DD} - 0.1$		V	1, 2, 20
V_{OL}	Low Level Output Voltage ⁽⁷⁾⁽⁸⁾	$I_F = 10\text{mA}$, $I_O = 2.5\text{A}$		$V_{SS} + 2.5$	$V_{SS} + 6.25$	V	4
		$I_F = 0\text{mA}$, $I_O = 100\text{mA}$		$V_{SS} + 0.1$	$V_{SS} + 0.5$	V	5, 21
I_{DDH}	High Level Supply Current	V_O Open, $I_F = 10$ to 16mA		2.9	5	mA	7, 8, 22
I_{DDL}	Low Level Supply Current	V_O Open, $V_F = 0$ to 0.8V		2.8	5	mA	7, 8, 23
I_{FLH}	Threshold Input Current Low to High	$I_O = 0\text{mA}$, $V_O > 5\text{V}$		2.4	7.5	mA	9, 15, 24
V_{FHL}	Threshold Input Voltage High to Low	$I_O = 0\text{mA}$, $V_O < 5\text{V}$	0.8			V	25
V_{UVLO+}	UnderVoltage Lockout Threshold	$I_F = 10\text{mA}$, $V_O > 5\text{V}$	11.5	12.7	14.5	V	17, 26
V_{UVLO-}		$I_F = 10\text{mA}$, $V_O < 5\text{V}$	10.0	11.2	13.0	V	17, 26
$UVLO_{HYS}$	UnderVoltage Lockout Threshold Hysteresis			1.5		V	

Notes:

- In this test, V_{OH} is measured with a dc load current of 100mA. When driving capacitive load V_{OH} will approach V_{DD} as I_{OH} approaches zero amps.
- Maximum pulse width = 1ms, maximum duty cycle = 20%.

Switching Characteristics

Apply over all recommended conditions, typical value is measured at $V_{DD} = 30V$, $V_{SS} = \text{Ground}$, $T_A = 25^\circ\text{C}$ unless otherwise specified.

Symbol	Parameter	Conditions	Min.	Typ.	Max.	Units	Figure	
t_{PHL}	Propagation Delay Time to Logic Low Output ⁽⁹⁾	$I_F = 10\text{mA to } 16\text{mA}$, $R_g = 10\Omega$, $C_g = 10\text{nF}$, $f = 10\text{kHz}$, Duty Cycle = 50%	100	285	500	ns	10, 11, 12, 13, 14, 27	
t_{PLH}	Propagation Delay Time to Logic High Output ⁽¹⁰⁾		100	260	500	ns	10, 11, 12, 13, 14, 27	
PWD	Pulse Width Distortion ⁽¹¹⁾ $ t_{PHL} - t_{PLH} $				25	300	ns	
PDD (Skew)	Propagation Delay Difference Between Any Two Parts ⁽¹²⁾			-350		350		
t_R	Output Rise Time (10% to 90%)				60		ns	27
t_F	Output Fall Time (90% to 10%)				60		ns	27
$t_{ULVO\ ON}$	ULVO Turn On Delay		$I_F = 10\text{mA}$, $V_O > 5V$		0.8		μs	
$t_{ULVO\ OFF}$	ULVO Turn Off Delay	$I_F = 10\text{mA}$, $V_O < 5V$		0.4		μs		
$ CM_H $	Common Mode Transient Immunity at Output High	$T_A = 25^\circ\text{C}$, $V_{DD} = 30V$, $I_F = 10 \text{ to } 16\text{mA}$, $V_{CM} = 2000V^{(13)}$	20	50		$\text{kV}/\mu\text{s}$	28	
$ CM_L $	Common Mode Transient Immunity at Output Low	$T_A = 25^\circ\text{C}$, $V_{DD} = 30V$, $V_F = 0V$, $V_{CM} = 2000V^{(14)}$	20	50		$\text{kV}/\mu\text{s}$	28	

Notes:

- t_{PHL} propagation delay is measured from the 50% level on the falling edge of the input pulse to the 50% level of the falling edge of the V_O signal.
- t_{PLH} propagation delay is measured from the 50% level on the rising edge of the input pulse to the 50% level of the rising edge of the V_O signal.
- PWD is defined as $|t_{PHL} - t_{PLH}|$ for any given device.
- The difference between t_{PHL} and t_{PLH} between any two FOD8321 parts under same operating conditions, with equal loads.
- Common mode transient immunity at output high is the maximum tolerable negative dV_{cm}/dt on the trailing edge of the common mode impulse signal, V_{cm} , to assure that the output will remain high (i.e. $V_O > 15.0V$).
- Common mode transient immunity at output low is the maximum tolerable positive dV_{cm}/dt on the leading edge of the common pulse signal, V_{cm} , to assure that the output will remain low (i.e. $V_O < 1.0V$).

Typical Performance Characteristics

Figure 1. Output High Voltage Drop vs. Output High Current

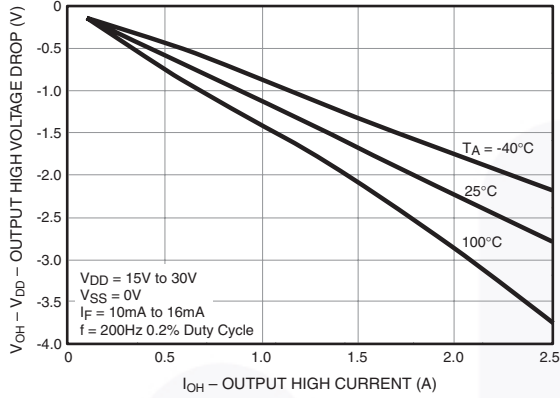

Figure 2. Output High Voltage Drop vs. Ambient Temperature

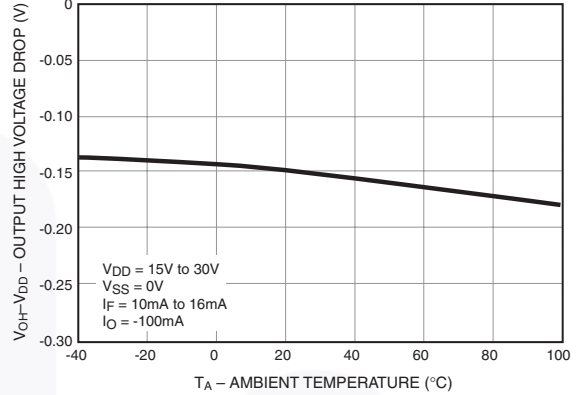

Figure 3. Output High Current vs. Ambient Temperature

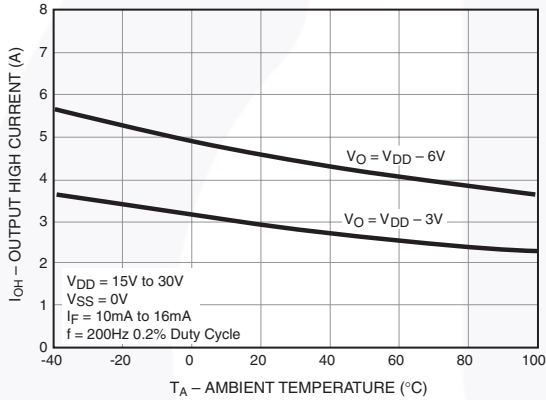

Figure 4. Output Low Voltage vs. Output Low Current

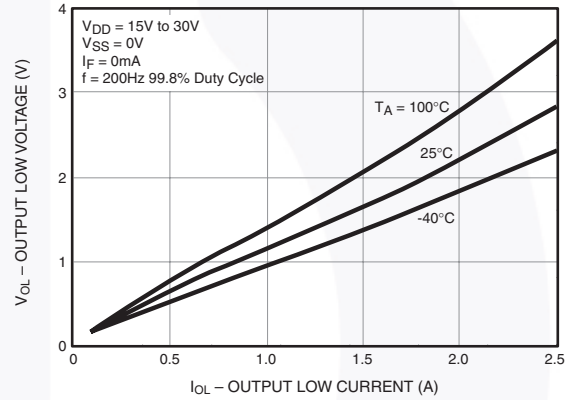

Figure 5. Output Low Voltage vs. Ambient Temperature

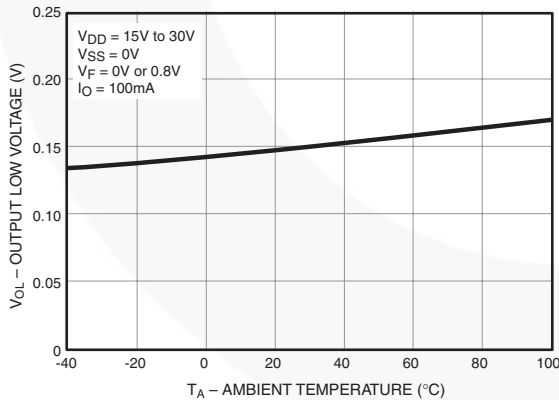
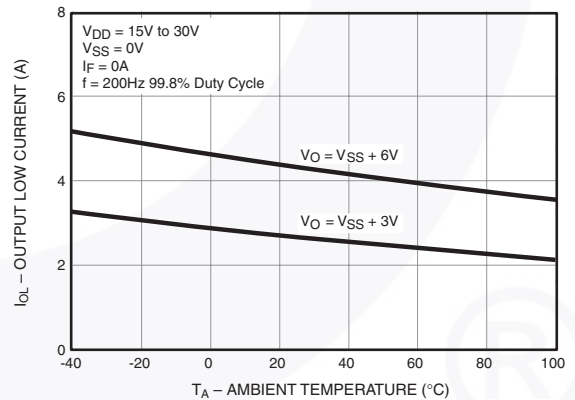

Figure 6. Output Low Current vs. Ambient Temperature



Typical Performance Characteristics (Continued)

Figure 7. Supply Current vs. Ambient Temperature

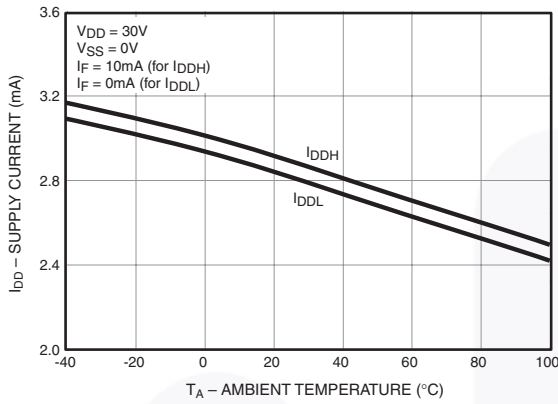

Figure 8. Supply Current vs. Supply Voltage

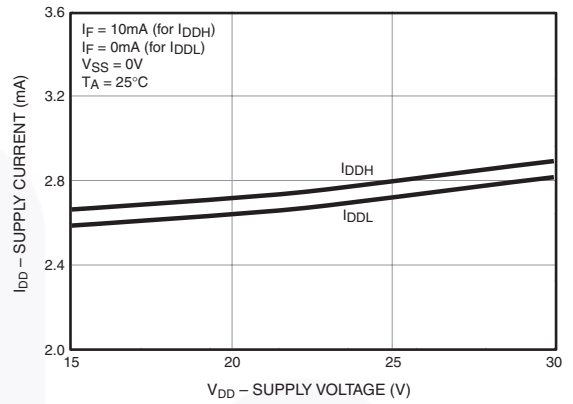

Figure 9. Low to High Input Current Threshold vs. Ambient Temperature

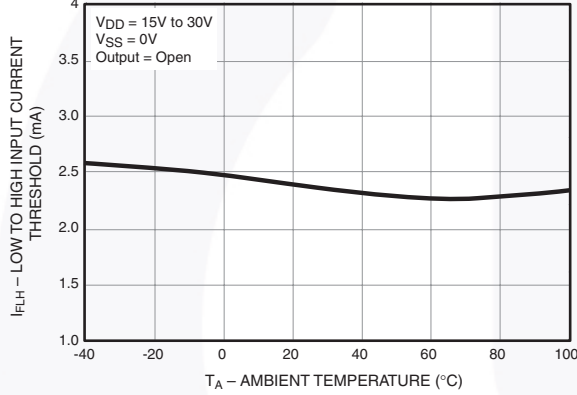

Figure 10. Propagation Delay vs. Supply Voltage

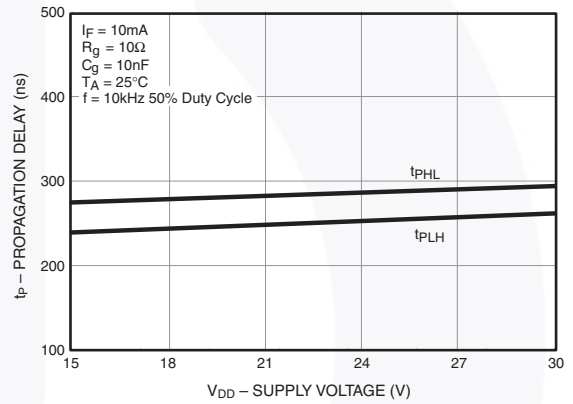

Figure 11. Propagation Delay vs. LED Forward Current

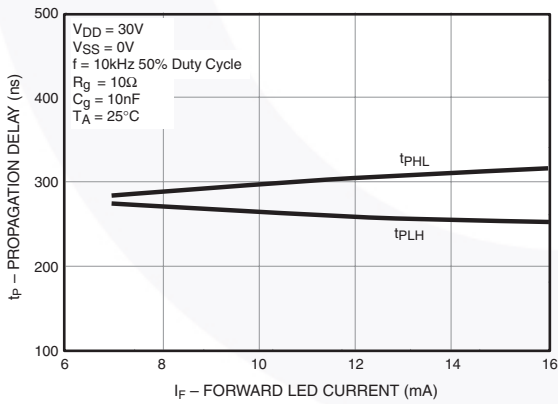
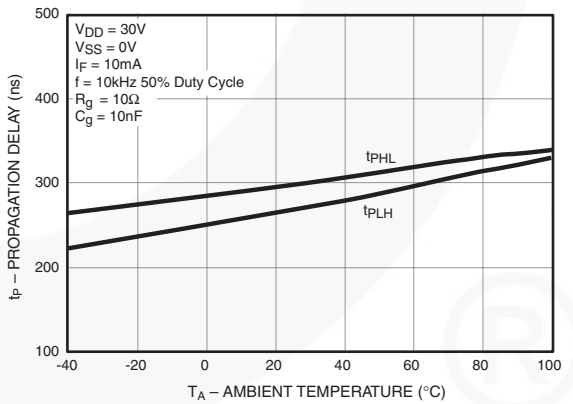

Figure 12. Propagation Delay vs. Ambient Temperature



Typical Performance Characteristics (Continued)

Figure 13. Propagation Delay vs. Series Load Resistance

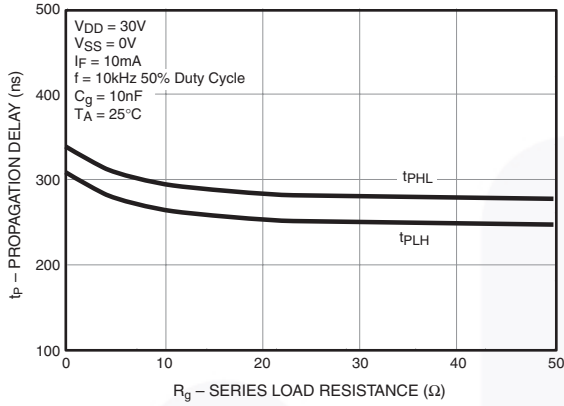

Figure 14. Propagation Delay vs. Load Capacitance

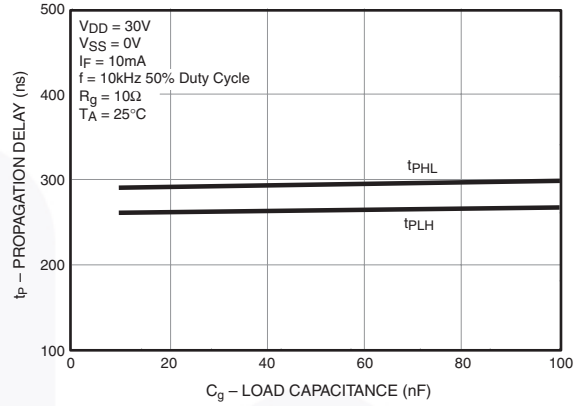

Figure 15. Transfer Characteristics

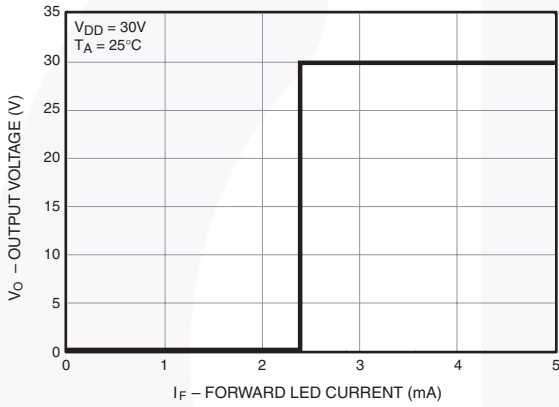

Figure 16. Input Forward Current vs. Forward Voltage

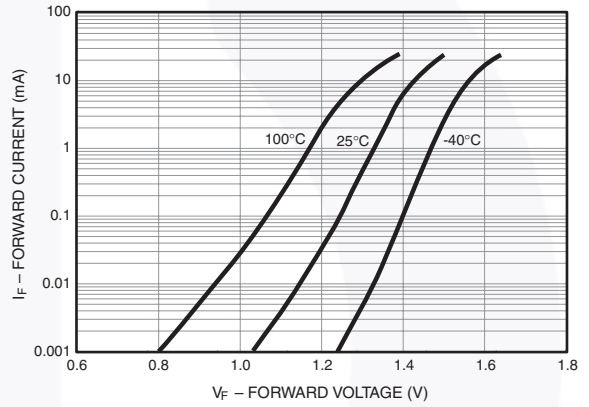
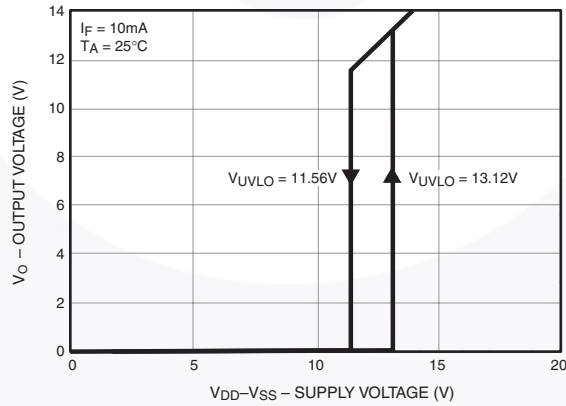
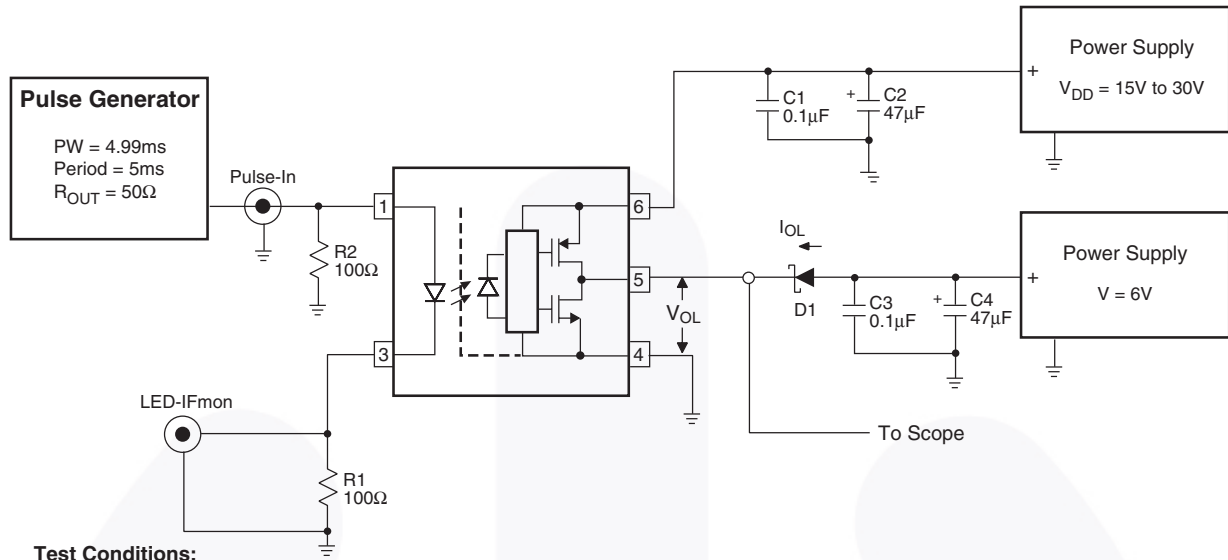

Figure 17. Under Voltage Lockout



Test Circuit



Test Conditions:
 Frequency = 200Hz
 Duty Cycle = 99.8%
 $V_{DD} = 15V$ to $30V$
 $V_{SS} = 0V$
 $I_F = 0mA$

Figure 18. I_{OL} Test Circuit

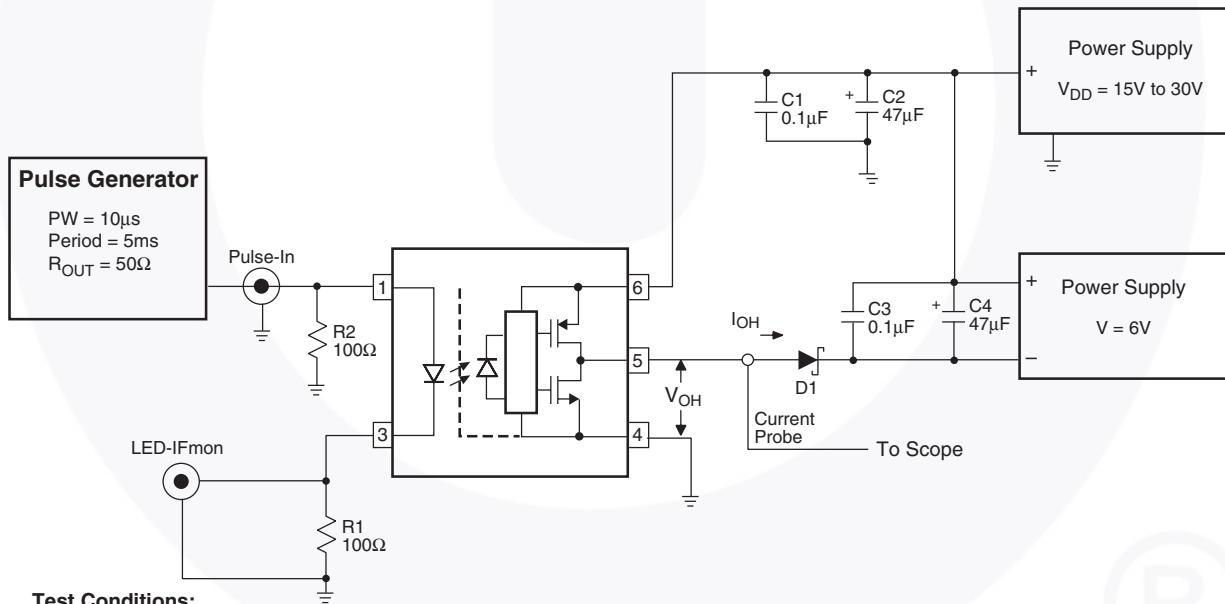

Test Conditions:
 Frequency = 200Hz
 Duty Cycle = 0.2%
 $V_{DD} = 15V$ to $30V$
 $V_{SS} = 0V$
 $I_F = 10mA$ to $16mA$

Figure 19. I_{OH} Test Circuit

Test Circuit (Continued)

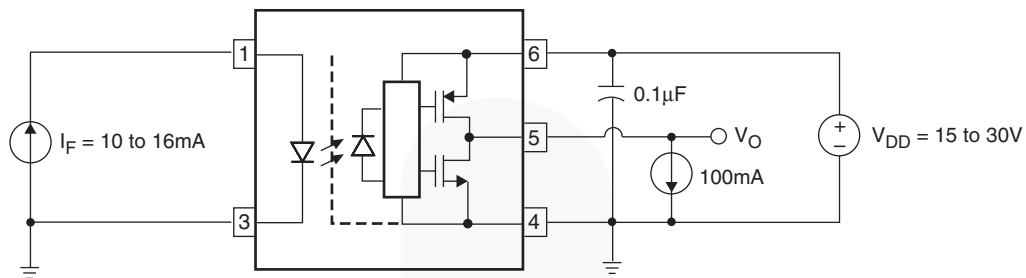

Figure 20. V_{OH} Test Circuit

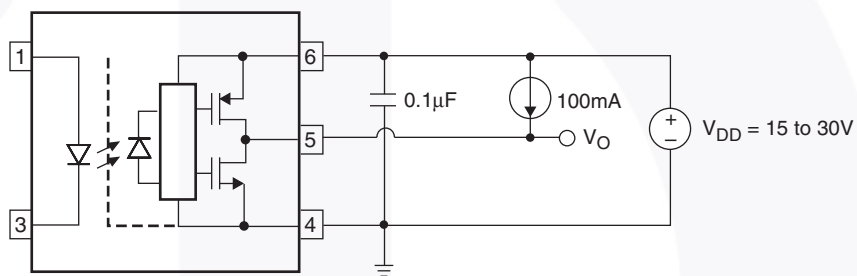

Figure 21. V_{OL} Test Circuit



Test Circuit (Continued)

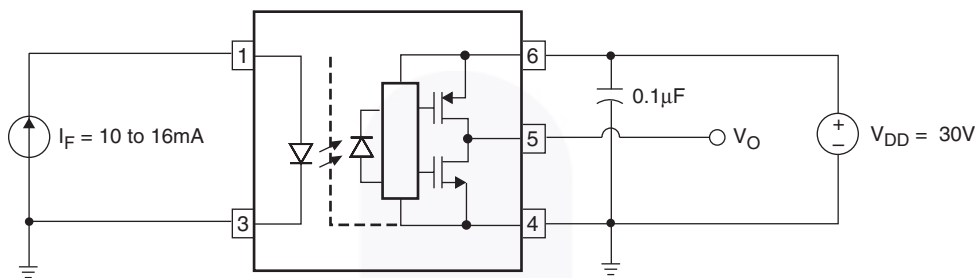

Figure 22. I_{DDH} Test Circuit

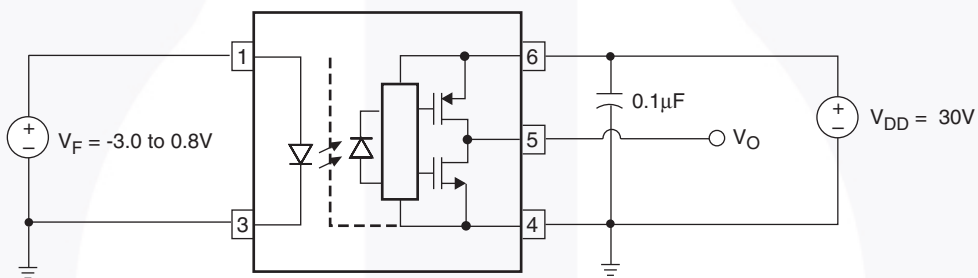

Figure 23. I_{DDL} Test Circuit



Test Circuit (Continued)

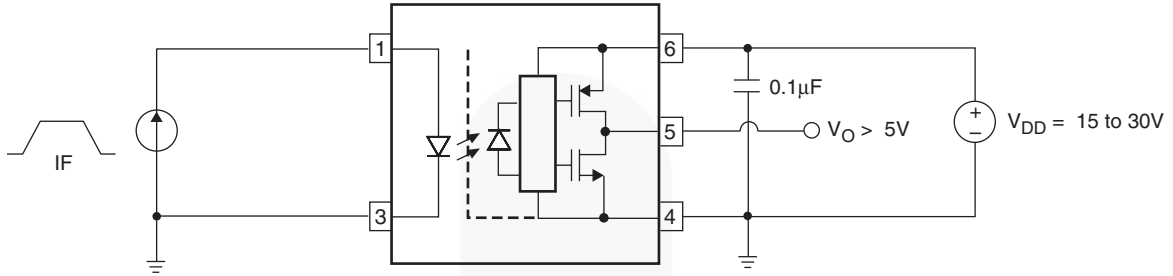

Figure 24. I_{FLH} Test Circuit

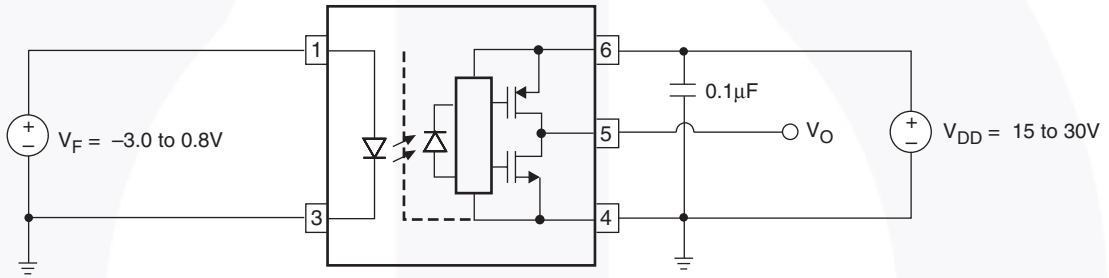

Figure 25. V_{FHL} Test Circuit

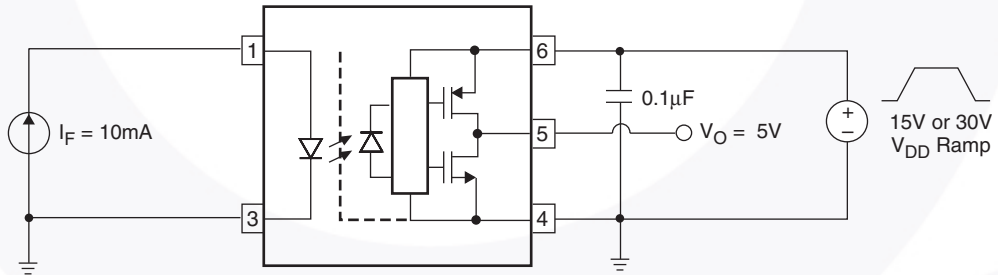

Figure 26. UVLO Test Circuit

Test Circuit (Continued)

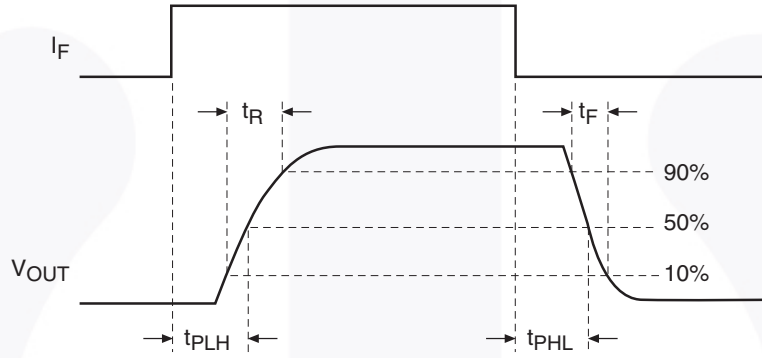
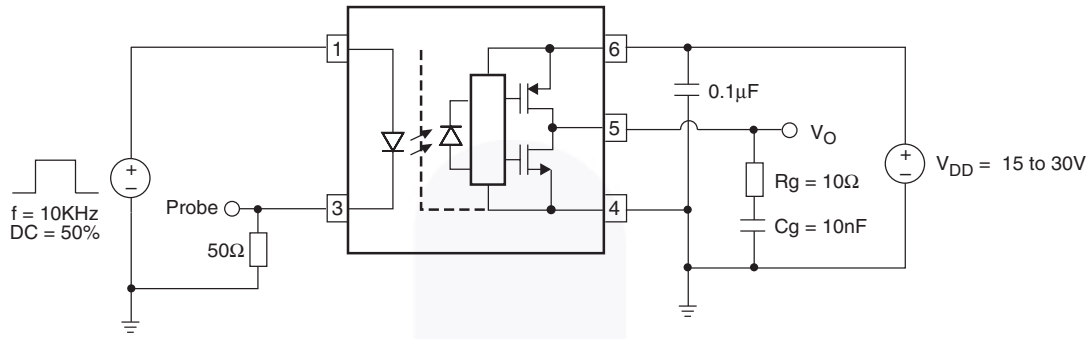

Figure 27. t_{PHL} , t_{PLH} , t_R and t_F Test Circuit and Waveforms

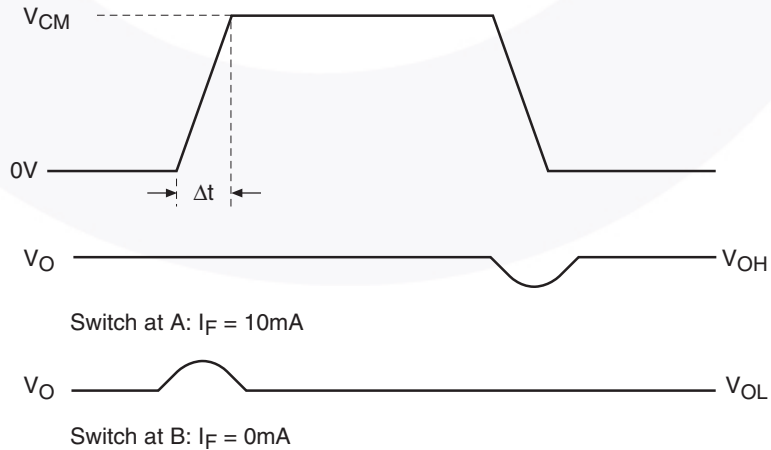
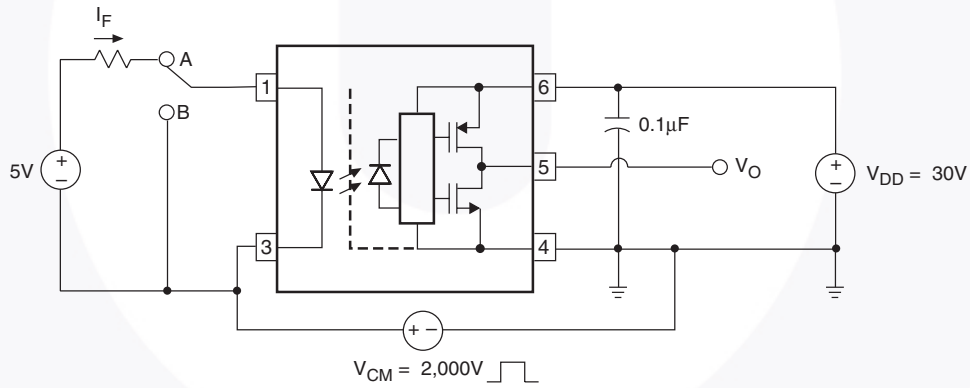



Figure 28. CMR Test Circuit and Waveforms

Ordering Information

Part Number	Package	Packing Method
FOD8321	Wide Body SOP 5-Pin	Tube (100 units per tube)
FOD8321R2	Wide Body SOP 5-Pin	Tape and Reel (1,000 units per reel)
FOD8321V	Wide Body SOP 5-Pin, DIN EN/IEC60747-5-5 Option	Tube (100 units per tube)
FOD8321R2V	Wide Body SOP 5-Pin, DIN EN/IEC60747-5-5 Option	Tape and Reel (1,000 units per reel)

 All packages are lead free per JEDEC: J-STD-020B standard.

Marking Information

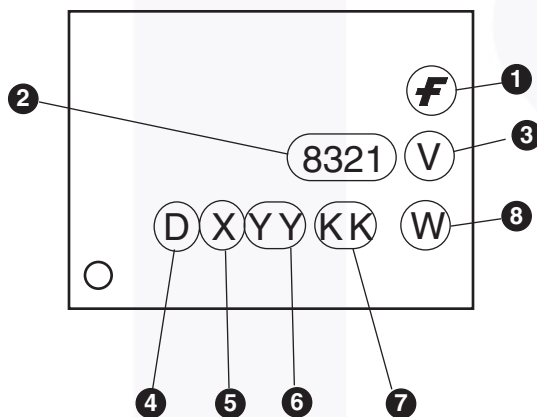

Definitions	
1	Fairchild logo
2	Device number, e.g., '8321' for FOD8321
3	DIN EN/IEC60747-5-5 Option (only appears on component ordered with this option)
4	Plant code, e.g., 'D'
5	Last digit year code, e.g., 'C' for 2012
6	Two digit work week ranging from '01' to '53'
7	Lot traceability code
8	Package assembly code, W

Reflow Profile

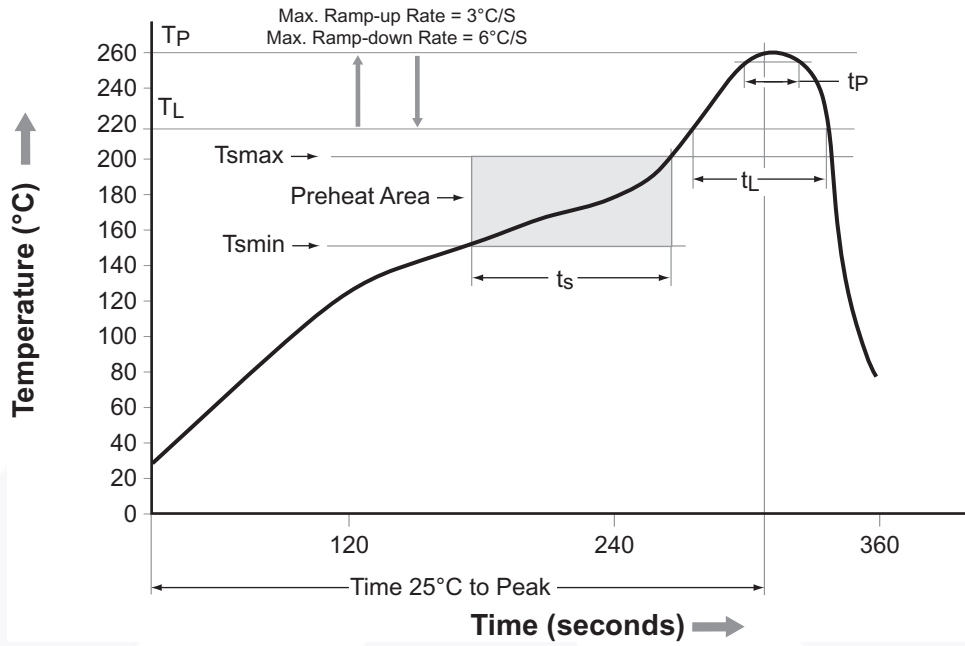

Profile Feature	Pb-Free Assembly Profile
Temperature Min. (T _{smin})	150°C
Temperature Max. (T _{smax})	200°C
Time (t _s) from (T _{smin} to T _{smax})	60–120 seconds
Ramp-up Rate (t _L to t _P)	3°C/second max.
Liquidous Temperature (T _L)	217°C
Time (t _L) Maintained Above (T _L)	60–150 seconds
Peak Body Package Temperature	260°C +0°C / -5°C
Time (t _P) within 5°C of 260°C	30 seconds
Ramp-down Rate (T _P to T _L)	6°C/second max.
Time 25°C to Peak Temperature	8 minutes max.

Carrier Tape Specification (SOIC-5L OPTO R2 & R2V Option)

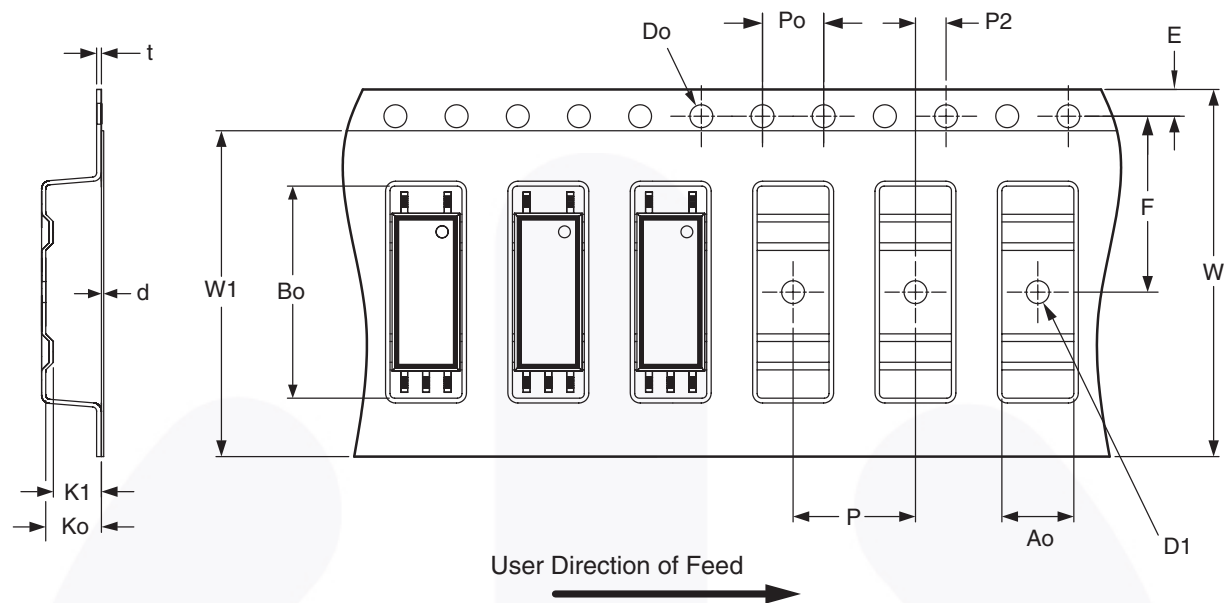



Symbol	Description	Dimension in mm
W	Tape Width	24.00 + 0.20 / -0.10
t	Tape Thickness	0.30 ± 0.05
Po	Sprocket Hole Pitch	4.00 ± 0.20
Do	Sprocket Hole Diameter	1.50 + 0.10 / -0.00
D1	Pocket Hole Diameter	1.50 + 0.25 / -0.00
E	Sprocket Hole Location	1.75 ± 0.10
F	Pocket Location	11.50 ± 0.10
P2		2.00 ± 0.10
P	Pocket Pitch	8.00 ± 0.10
Ao	Pocket Dimension	4.50 ± 0.10
Bo		12.00 ± 0.10
Ko		3.35 ± 0.10
K1		2.85 ± 0.10
W1	Cover Tape Width	21.30 ± 0.10
d	Cover Tape Thickness	0.05 ± 0.01
	Max Component Rotation or Tilt	10°



TRADEMARKS

The following includes registered and unregistered trademarks and service marks, owned by Fairchild Semiconductor and/or its global subsidiaries, and is not intended to be an exhaustive list of all such trademarks.

- | | | | |
|---|--|---|---|
| 2Cool™ | F-PFS™ | PowerTrench® | The Power Franchise® |
| AccuPower™ | FRFET® | PowerXS™ | the power franchise |
| AX-CAP™* | Global Power Resource™ | Programmable Active Droop™ | TinyBoost™ |
| BitSiC™ | GreenBridge™ | QFET® | TinyBuck™ |
| Build it Now™ | Green FPS™ | QS™ | TinyCalc™ |
| CorePLUS™ | Green FPS™ e-Series™ | Quiet Series™ | TinyLogic® |
| CorePOWER™ | Gmax™ | RapidConfigure™ | TINYOPTO™ |
| CROSSVOLT™ | GTO™ |  | TinyPower™ |
| CTL™ | IntelliMAX™ | Saving our world, 1mW/W/kW at a time™ | TinyPWM™ |
| Current Transfer Logic™ | ISOPLANAR™ | SignalWise™ | TinyWire™ |
| DEUXPEED® | Making Small Speakers Sound Louder and Better™ | SmartMax™ | TranSiC™ |
| Dual Cool™ | MegaBuck™ | SMART START™ | TriFault Detect™ |
| EcoSPARK® | MICROCOUPLER™ | Solutions for Your Success™ | TRUECURRENT®* |
| EfficientMax™ | MicroFET™ | SPM® | µSerDes™ |
| ESBC™ | MicroPak™ | STEALTH™ |  |
|  | MicroPak2™ | SuperFET® | UHC® |
| Fairchild® | MillerDrive™ | SuperSOT™-3 | Ultra FRFET™ |
| Fairchild Semiconductor® | MotionMax™ | SuperSOT™-6 | UniFET™ |
| FACT Quiet Series™ | mWSaver™ | SuperSOT™-8 | VCX™ |
| FACT® | OptoHiT™ | SupreMOS® | VisualMax™ |
| FAST® | OPTOLOGIC® | SyncFET™ | VoltagePlus™ |
| FastvCore™ | OPTOPLANAR® | Sync-Lock™ | XS™ |
| FETBench™ | |  | |
| FlashWriter®* | | | |
| FPS™ | | | |

* Trademarks of System General Corporation, used under license by Fairchild Semiconductor.

DISCLAIMER

FAIRCHILD SEMICONDUCTOR RESERVES THE RIGHT TO MAKE CHANGES WITHOUT FURTHER NOTICE TO ANY PRODUCTS HEREIN TO IMPROVE RELIABILITY, FUNCTION, OR DESIGN. FAIRCHILD DOES NOT ASSUME ANY LIABILITY ARISING OUT OF THE APPLICATION OR USE OF ANY PRODUCT OR CIRCUIT DESCRIBED HEREIN; NEITHER DOES IT CONVEY ANY LICENSE UNDER ITS PATENT RIGHTS, NOR THE RIGHTS OF OTHERS. THESE SPECIFICATIONS DO NOT EXPAND THE TERMS OF FAIRCHILD'S WORLDWIDE TERMS AND CONDITIONS, SPECIFICALLY THE WARRANTY THEREIN, WHICH COVERS THESE PRODUCTS.

LIFE SUPPORT POLICY

FAIRCHILD'S PRODUCTS ARE NOT AUTHORIZED FOR USE AS CRITICAL COMPONENTS IN LIFE SUPPORT DEVICES OR SYSTEMS WITHOUT THE EXPRESS WRITTEN APPROVAL OF FAIRCHILD SEMICONDUCTOR CORPORATION.

As used herein:

1. Life support devices or systems are devices or systems which, (a) are intended for surgical implant into the body or (b) support or sustain life, and (c) whose failure to perform when properly used in accordance with instructions for use provided in the labeling, can be reasonably expected to result in a significant injury of the user.
2. A critical component in any component of a life support, device, or system whose failure to perform can be reasonably expected to cause the failure of the life support device or system, or to affect its safety or effectiveness.

ANTI-COUNTERFEITING POLICY

Fairchild Semiconductor Corporation's Anti-Counterfeiting Policy. Fairchild's Anti-Counterfeiting Policy is also stated on our external website, www.fairchildsemi.com, under Sales Support.

Counterfeiting of semiconductor parts is a growing problem in the industry. All manufacturers of semiconductor products are experiencing counterfeiting of their parts. Customers who inadvertently purchase counterfeit parts experience many problems such as loss of brand reputation, substandard performance, failed applications, and increased cost of production and manufacturing delays. Fairchild is taking strong measures to protect ourselves and our customers from the proliferation of counterfeit parts. Fairchild strongly encourages customers to purchase Fairchild parts either directly from Fairchild or from Authorized Fairchild Distributors who are listed by country on our web page cited above. Products customers buy either from Fairchild directly or from Authorized Fairchild Distributors are genuine parts, have full traceability, meet Fairchild's quality standards for handling and storage and provide access to Fairchild's full range of up-to-date technical and product information. Fairchild and our Authorized Distributors will stand behind all warranties and will appropriately address any warranty issues that may arise. Fairchild will not provide any warranty coverage or other assistance for parts bought from Unauthorized Sources. Fairchild is committed to combat this global problem and encourage our customers to do their part in stopping this practice by buying direct or from authorized distributors.

PRODUCT STATUS DEFINITIONS

Definition of Terms

Datasheet Identification	Product Status	Definition
Advance Information	Formative / In Design	Datasheet contains the design specifications for product development. Specifications may change in any manner without notice.
Preliminary	First Production	Datasheet contains preliminary data; supplementary data will be published at a later date. Fairchild Semiconductor reserves the right to make changes at any time without notice to improve design.
No Identification Needed	Full Production	Datasheet contains final specifications. Fairchild Semiconductor reserves the right to make changes at any time without notice to improve the design.
Obsolete	Not In Production	Datasheet contains specifications on a product that is discontinued by Fairchild Semiconductor. The datasheet is for reference information only.

Rev. 162