

KA5Q0765RTH

Fairchild Power Switch(FPS)

Features

- Quasi Resonant Converter Controller
- Internal Burst Mode Controller for Stand-by Mode
- Pulse by Pulse Current Limiting
- Over Current Latch Protection
- Over Voltage Protection (Vsync: Min. 11V)
- Internal Thermal Shutdown Function
- Under Voltage Lockout
- Internal High Voltage Sense FET
- Auto-Restart Mode
- Primary Side Regulation

Description

The Fairchild Power Switch(FPS) product family is specially designed for an off-line SMPS with minimal external components. The Fairchild Power Switch(FPS) consists of a high voltage power SenseFET and a current mode PWM IC. The integrated PWM controller includes the fixed oscillator, the under voltage lock out, the leading edge blanking, the optimized gate turn-on/turn-off driver, the thermal shut down protection, the over voltage protection, and the temperature compensated precision current sources for loop compensation and fault protection circuitry. Compared to a discrete MOSFET and a controller or a RCC switching converter solutions, a Fairchild Power Switch(FPS) can reduce the total number of components, design size, and weight, so it will improve efficiency, productivity, and system reliability. It has a basic platform well suited for cost-effective design in a quasi-resonant converter as a C-TV power supply.

TO-220F-5L



1. Drain
2. GND
3. VCC
4. Feedback
5. Sync

Internal Block Diagram

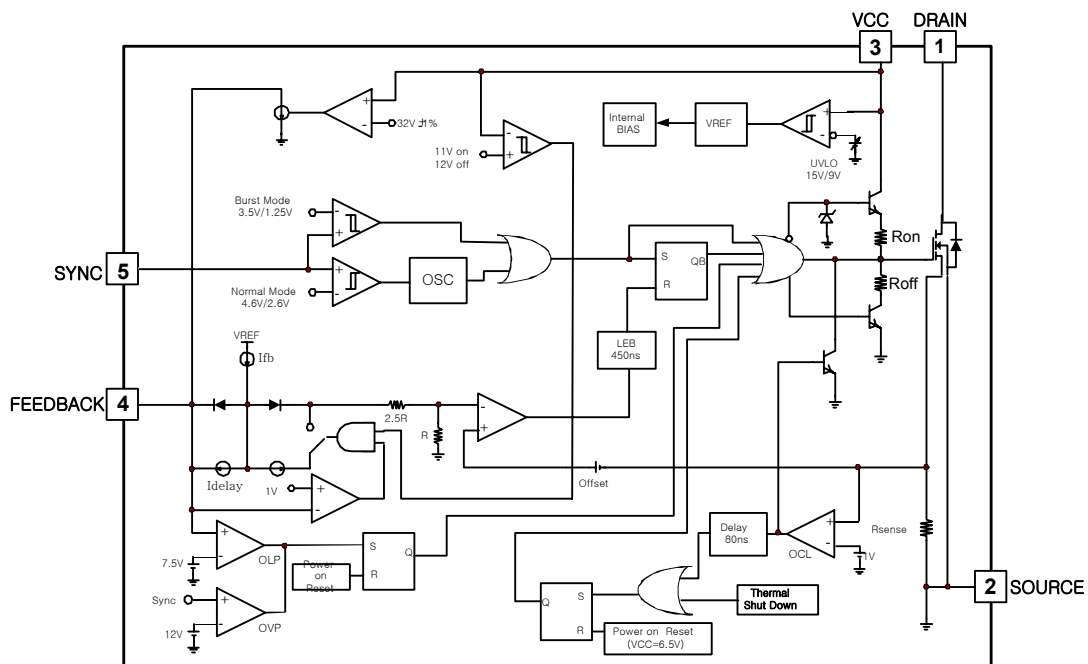

Rev.1.0.2

Absolute Maximum Ratings

(Ta=25°C, unless otherwise specified)

Parameter	Symbol	Value	Unit
Drain-Gate Voltage (RGS=1MΩ)	V _{DGR}	650	V
Gate-Source (GND) Voltage	V _{GS}	±30	V
Drain Current Pulsed ⁽²⁾	I _{DM}	28	ADC
Single Pulsed Avalanche Energy ⁽³⁾	E _{AS}	370	mJ
Avalanch Current ⁽⁴⁾	I _{AS}	17	A
Continuous Drain Current (T _c = 25°C)	I _D	7	ADC
Continuous Drain Current (T _C =100°C)	I _D	4.5	ADC
Supply Voltage	V _{CC}	40	V
Analog Input Voltage Range	V _{sync}	-0.3 to 13V	V
	V _{FB}	-0.3 to V _{CC}	V
Total Power Dissipation	P _D	45	W
Operating Junction Temperature	T _J	+150	°C
Operating Ambient Temperature	T _A	-25 to +85	°C
Storage Temperature Range	T _{STG}	-55 to +150	°C
Thermal Resistance	R _{thjc}	2.98	°C/W

Notes:

1. T_j = 25°C to 150°C
2. Repetitive rating: Pulse width limited by maximum junction temperature
3. L = 30mH, V_{DD} = 50V, R_G = 25Ω, starting T_j = 25°C
4. L = 13uH, starting T_j = 25°C

Electrical Characteristics (SFET Part)

(Ta=25°C unless otherwise specified)

Parameter	Symbol	Condition	Min.	Typ.	Max.	Unit
Drain-Source Breakdown Voltage	BVDSS	VGS = 0V, ID = 250 μ A	650	-	-	V
Zero Gate Voltage Drain Current	IDSS	VDS = Max, Rating, VGS = 0V	-	-	200	μ A
		VDS = 0.8*Max., Rating VGS = 0V, TC = 85°C	-	-	300	μ A
Static Drain-source on Resistance ^(Note)	RDS(ON)	VGS = 10V, ID = 2.3A	-	1.4	1.6	Ω
Input Capacitance	Ciss	VGS = 0V, VDS = 25V, f = 1MHz	-	1415	-	pF
Output Capacitance	Coss		-	100	-	
Reverse Transfer Capacitance	Crss		-	15	-	
Turn on Delay Time	td(on)	VDD = 0.5BVDSS, ID = 7.0A (MOSFET switching time are essentially independent of operating temperature)	-	25	-	nS
Rise Time	tr		-	60	-	
Turn Off Delay Time	td(off)		-	110	-	
Fall Time	tf		-	65	-	
Total Gate Charge (Gate-Source+Gate-Drain)	Qg	VGS = 10V, ID = 7.0A, VDS = 0.5BVDSS (MOSFET Switching time are Essentially independent of operating temperature)	-	40	-	nC
Gate-Source Charge	Qgs		-	7	-	
Gate-Drain (Miller) Charge	Qgd		-	12	-	

Note:

1. Pulse test : Pulse width \leq 300 μ S, duty \leq 2%

Electrical Characteristics (Continued)

(Ta=25°C unless otherwise specified)

Parameter	Symbol	Condition	Min.	Typ.	Max.	Unit
UVLO SECTION						
Start Threshold Voltage	VSTART	VFB = GND	14	15	16	V
Stop Threshold Voltage	VSTOP	VFB = GND	8	9	10	V
SENSEFET SECTION						
Drain To PKG Breakdown Voltage	BVpkg	60HZ AC, Ta = 25°C	3500	-	-	V
Drain To Source Breakdown Voltage	BVdss	Ta = 25°C	650	-	-	V
Drain To Source Leakage Current	Idss	Vdrain = 400V, Ta = 25°C	-	-	200	uA
OSCILLATOR SECTION						
Initial Frequency	FOSC	-	18	20	22	kHz
Voltage Stability	FSTABLE	12V ≤ Vcc ≤ 23V	0	1	3	%
Temperature Stability (Note2)	ΔFOSC	-25°C ≤ Ta ≤ 85°C	0	±5	±10	%
Maximum Duty Cycle	DMAX	-	92	95	98	%
Minimum Duty Cycle	DMIN	-	-	-	0	%
FEEDBACK SECTION						
Feedback Source Current	IFB	VFB = GND	0.7	0.9	1.1	mA
Shutdown Feedback Voltage	VSD	Vfb ≥ 6.9V	6.9	7.5	8.1	V
Shutdown Delay Current	IDELAY	VFB = 5V	4	5	6	μA
PROTECTION SECTION						
Over Voltage Protection	VOVP	Vsync ≥ 11V	11	12	13	V
Over Current Latch Voltage (Note2)	VOCL	-	0.9	1.0	1.1	V
Thermal Shutdown Temp.	TSD	-	140	160	-	°C

Note:

1. These parameters is the current flowing in the Control IC.
2. These parameters, although guaranteed, are tested in EDS(wafer test) process.
3. These parameters indicate Inductor Current.

Electrical Characteristics (Continued)

(Ta=25°C unless otherwise specified)

Parameter	Symbol	Condition	Min.	Typ.	Max.	Unit
Sync SECTION						
Normal Sync High Threshold Voltage	VNSH	Vcc = 16V, Vfb = 5V	4.0	4.6	5.2	V
Normal Sync Low Threshold Voltage	VNSL	Vcc = 16V, Vfb = 5V	2.3	2.6	2.9	V
Burst Sync High Threshold Voltage	VBSH	Vcc = 10.5V, Vfb = 0V	3.2	3.6	4.0	V
Burst Sync Low Threshold Voltage	VBSL	Vcc = 10.5V, Vfb = 0V	1.1	1.3	1.5	V
BURST MODE SECTION						
Burst mode Low Threshold Voltage	VBURL	Vfb = 0V	10.4	11.0	11.6	V
Burst mode High Threshold Voltage	VBURH	Vfb = 0V	11.4	12.0	12.6	V
Burst mode Enable Feedback Voltage	VBEN	Vcc = 10.5V	0.7	1.0	1.3	V
Burst mode Peak Current Limit	IBU_PK	Vcc = 10.5V	0.65	0.85	1.1	A
PRIMARY SIDE REGULATION SECTION						
Primary Regulation Threshold Voltage	VPR	I _{fb} = 700uA, Vfb = 4V	32.0	32.5	33.0	V
Primary Regulation Transconductance	GPR	-	2.0	2.6	-	mA/V
CURRENT LIMIT(SELF-PROTECTION)SECTION						
Peak Current Limit(Note3)	IPK	-	4.4	5.0	5.6	A
TOTAL DEVICE SECTION						
Start Up Current	ISTART	Vfb = GND, VCC = 14V	-	0.1	0.2	mA
Operating Supply Current (Note1)	IOP	Vfb = GND, VCC = 16V	-	10	18	mA
	IOP(MIN)	Vfb = GND, VCC = 10V				
	IOP(MAX)	Vfb = GND, VCC = 28V				

Note:

1. These parameters is the current flowing in the Control IC.
2. These parameters, although guaranteed, are tested in EDS(wafer test) process.
3. These parameters indicate Inductor Current.

Typical Performance Characteristics

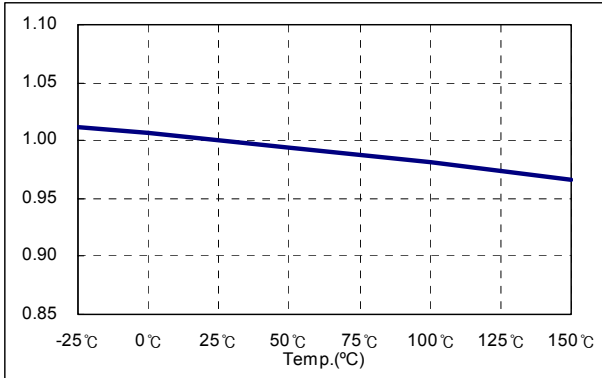

Figure 1. Start Voltage

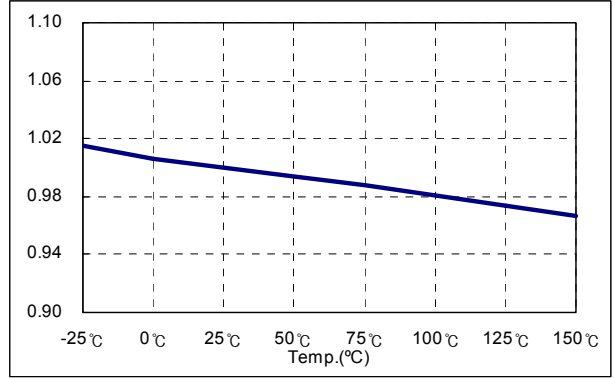

Figure 2. Stop Voltage

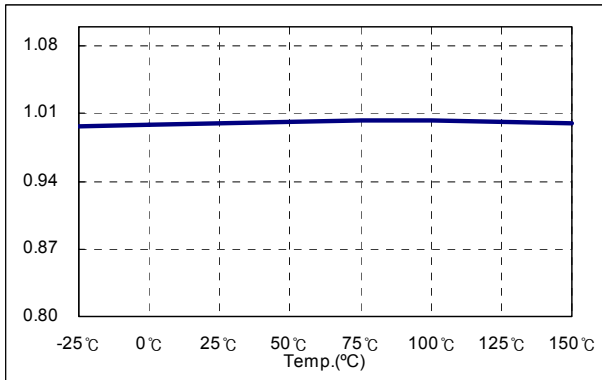

Figure 3. Stand by Current

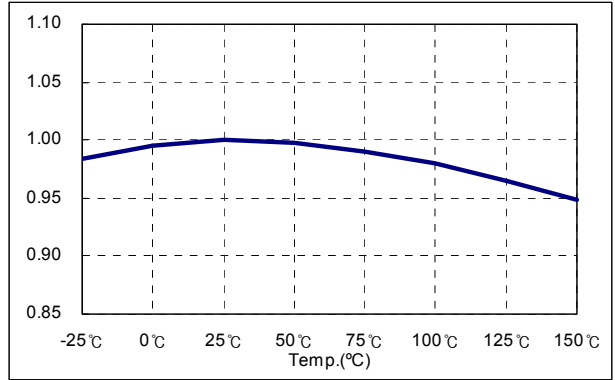

Figure 4. Operating Current

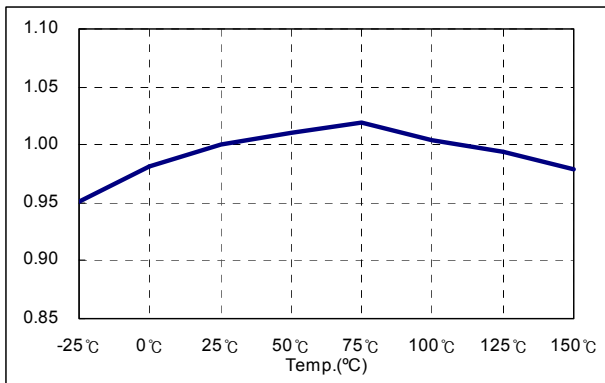

Figure 5. Initial Frequency

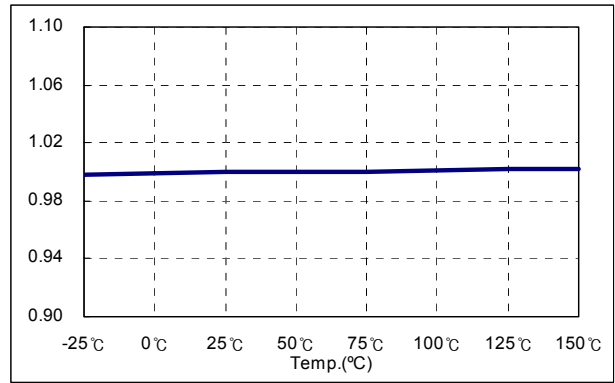

Figure 6. Maximum Duty

Typical Performance Characteristics (Continued)

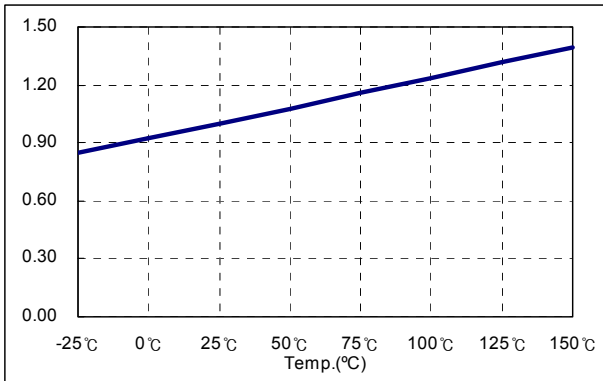

Figure 7. Feedback Offset Voltage

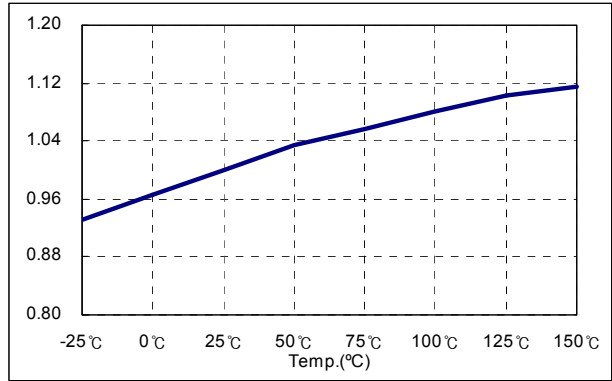

Figure 8. Feedback Source Current

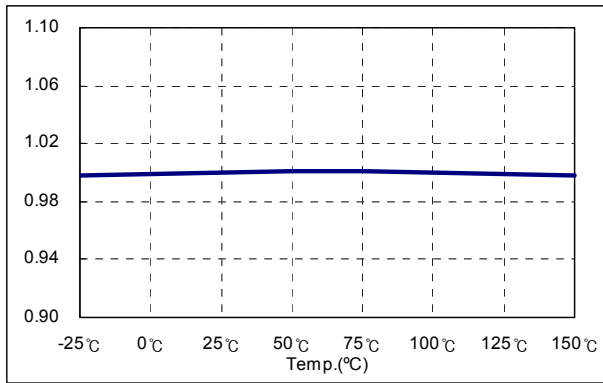

Figure 9. Over Voltage Protection

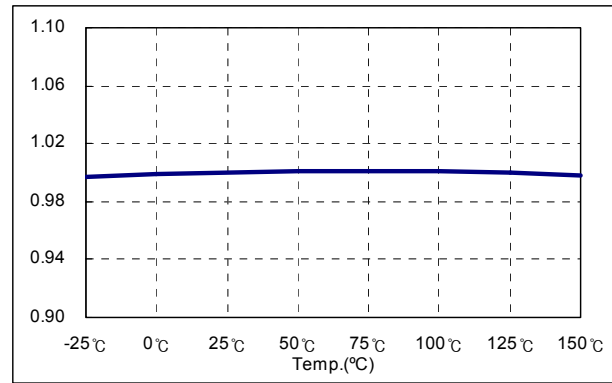

Figure 10. Shutdown Feedback Voltage

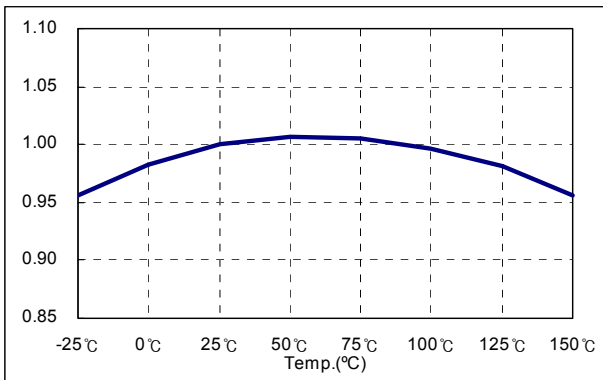

Figure 11. ShutDown Delay Current

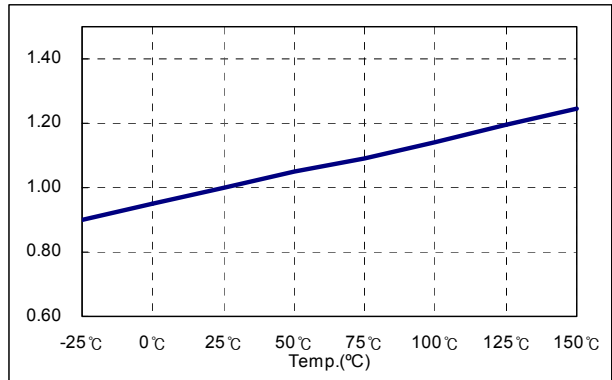

Figure 12. Burst Mode Enable Feedback Voltage

Typical Performance Characteristics (Continued)

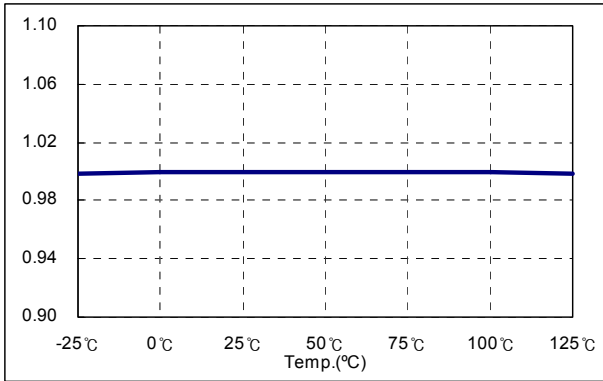

Figure 13. Burst Mode Low Threshold Voltage

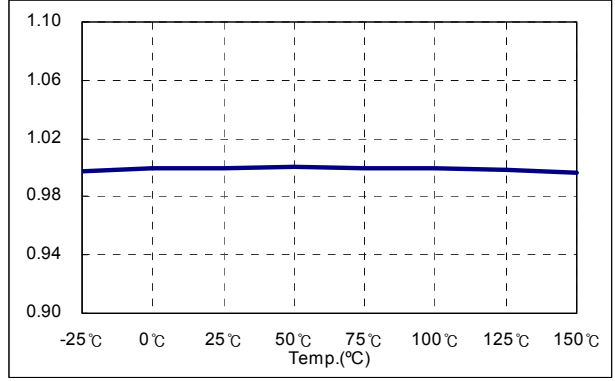

Figure 14. Burst Mode High Threshold Voltage

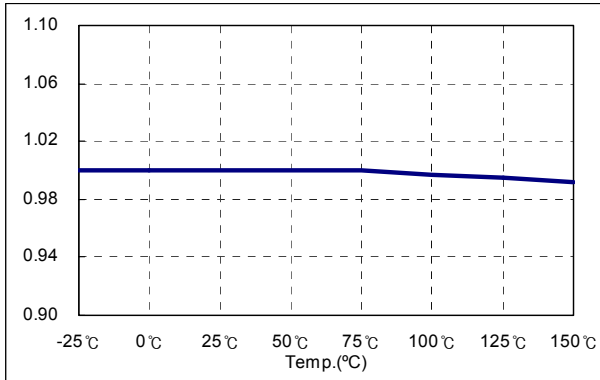

Figure 15. Burst Mode Sync. High Threshold Voltage

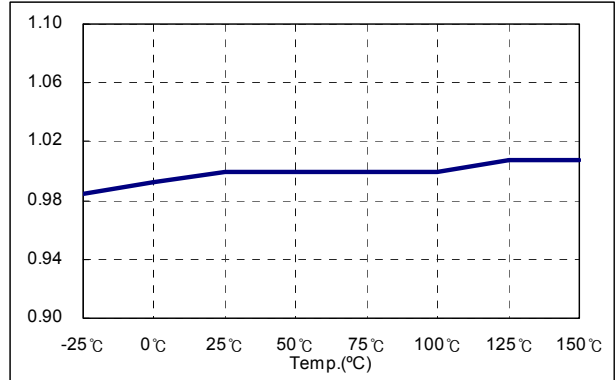

Figure 16. Burst Mode Sync. Low Threshold Voltage

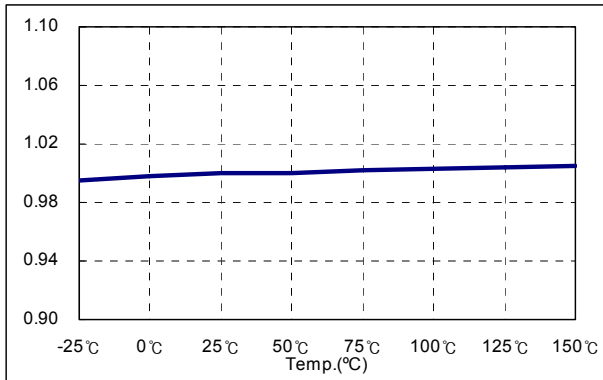

Figure 17. Primary Voltage

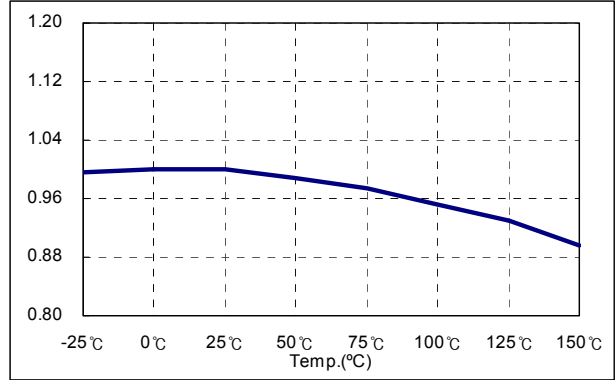

Figure 18. Primary Mode Gain

Typical Performance Characteristics (Continued)

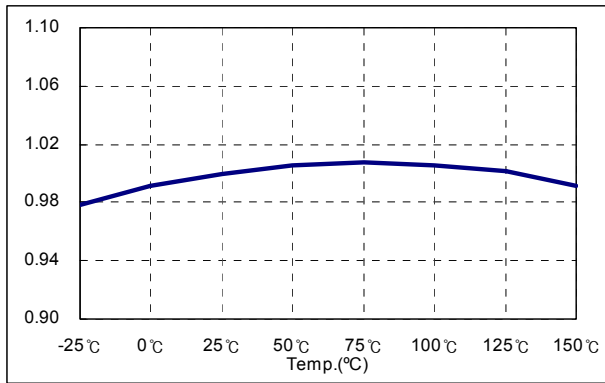

Figure 19. Peak Current Limit

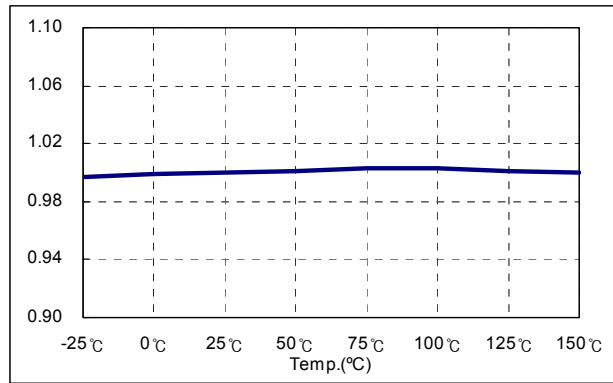

Figure 20. Burst Mode Peak Current Limit

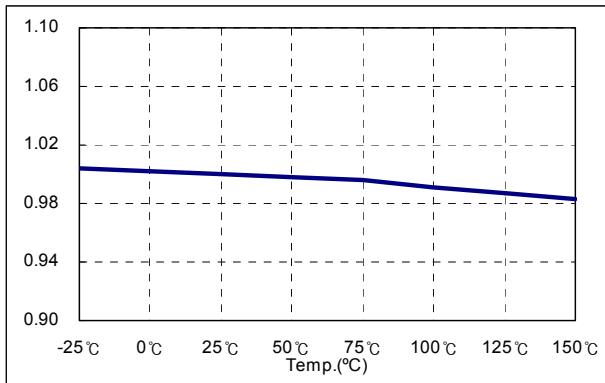

Figure 21. Normal Mode Sync. High Threshold Voltage

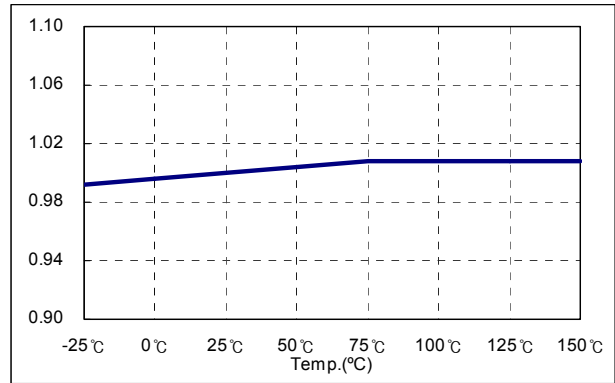

Figure 21. Normal Mode Sync. Low Threshold Voltage

Typical Performance Characteristics(MOSFET Part)

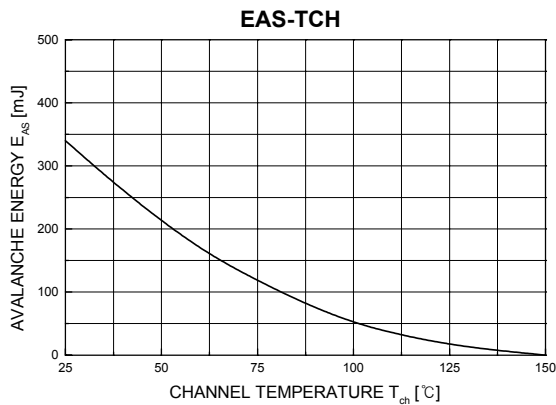

Figure 22. Temperature (T_C) vs. Eas Curve

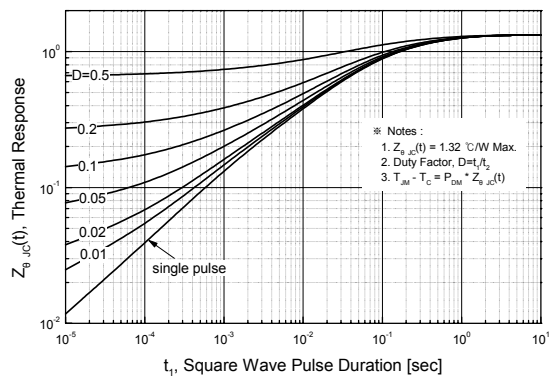
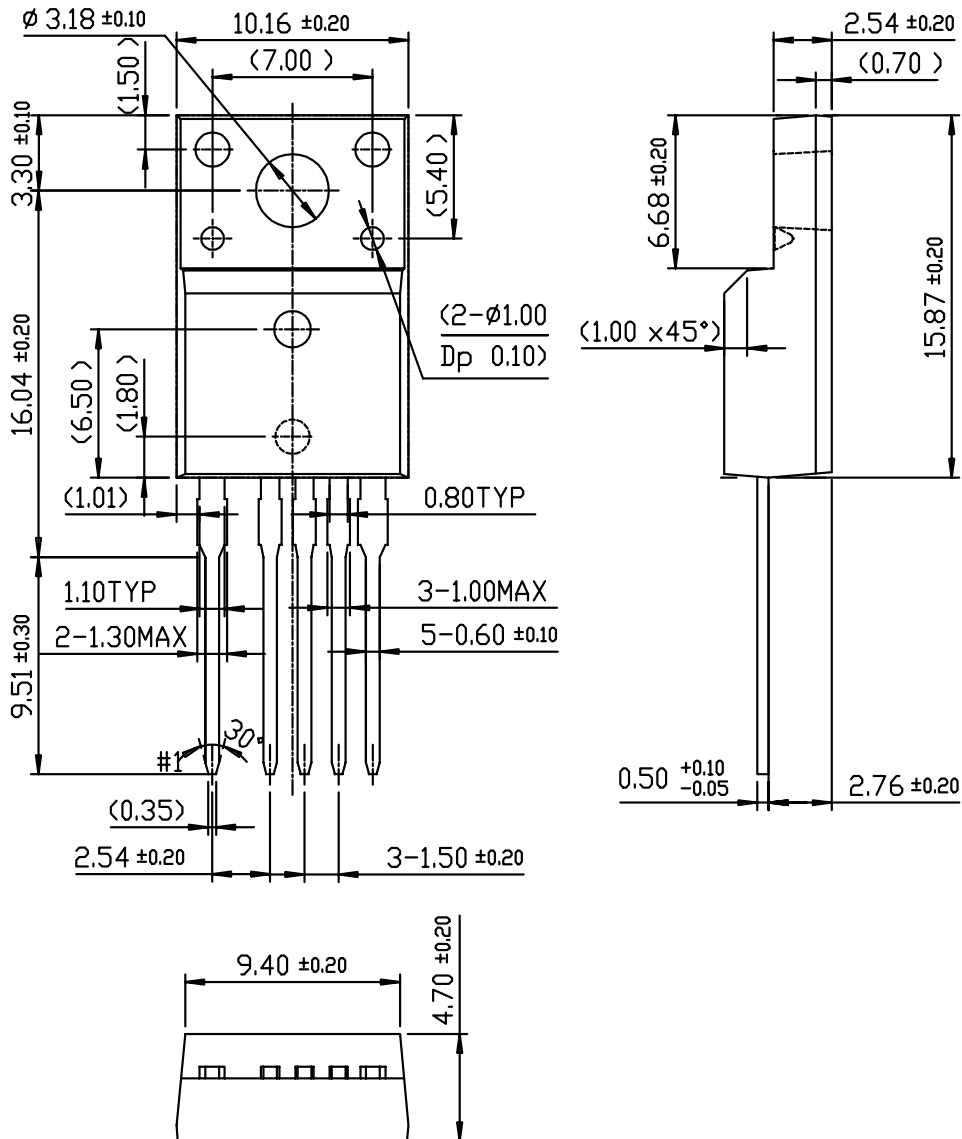

Figure 23. Transient Thermal Response Curve

Package Dimensions

TO-220F-5L



Package Dimensions (Continued)

TO-220F-5L(Forming)

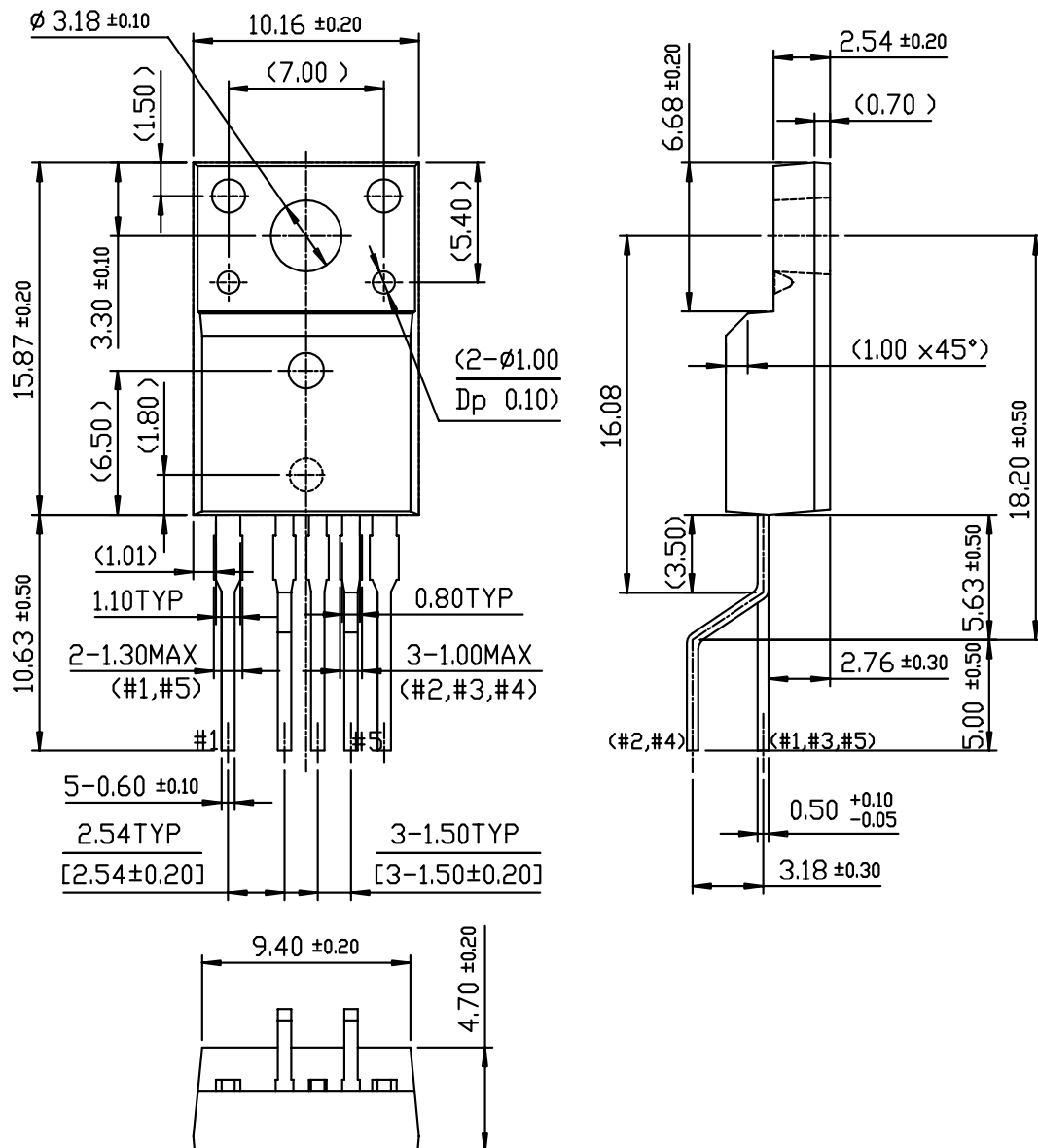

Ordering Information

Product Number	Package	Operating Temp.
KA5Q0765RTHTU	TO-220F-5L	-25°C to +85°C
KA5Q0765RTHYDTU	TO-220F-5L(Forming)	

TU : Non Forming Type

YDTU : Forming Type

DISCLAIMER

FAIRCHILD SEMICONDUCTOR RESERVES THE RIGHT TO MAKE CHANGES WITHOUT FURTHER NOTICE TO ANY PRODUCTS HEREIN TO IMPROVE RELIABILITY, FUNCTION OR DESIGN. FAIRCHILD DOES NOT ASSUME ANY LIABILITY ARISING OUT OF THE APPLICATION OR USE OF ANY PRODUCT OR CIRCUIT DESCRIBED HEREIN; NEITHER DOES IT CONVEY ANY LICENSE UNDER ITS PATENT RIGHTS, NOR THE RIGHTS OF OTHERS.

LIFE SUPPORT POLICY

FAIRCHILD'S PRODUCTS ARE NOT AUTHORIZED FOR USE AS CRITICAL COMPONENTS IN LIFE SUPPORT DEVICES OR SYSTEMS WITHOUT THE EXPRESS WRITTEN APPROVAL OF THE PRESIDENT OF FAIRCHILD SEMICONDUCTOR CORPORATION. As used herein:

1. Life support devices or systems are devices or systems which, (a) are intended for surgical implant into the body, or (b) support or sustain life, and (c) whose failure to perform when properly used in accordance with instructions for use provided in the labeling, can be reasonably expected to result in a significant injury of the user.
2. A critical component in any component of a life support device or system whose failure to perform can be reasonably expected to cause the failure of the life support device or system, or to affect its safety or effectiveness.