



FAN73892

3-Phase Half-Bridge Gate-Drive IC

Features

- Floating Channel for Bootstrap Operation to +600 V
- Typically 350 mA/650 mA Sourcing/Sinking Current-Driving Capability for All Channels
- Extended Allowable Negative V_S Swing to -9.8 V for Signal Propagation at $V_{DD}=V_{BS}=15$ V
- Outputs Out of Phase with Input Signals
- Over-Current Shutdown Turns Off All Six Drivers
- Matched Propagation Delay for All Channels
- 3.3 V and 5.0 V Input Logic Compatible
- Adjustable Fault-Clear Timing
- Built-in Advanced Input Filter
- Built-in Shoot-Through Prevention Logic
- Built-in Soft Turn-Off Function
- Common-Mode dv/dt Noise-Canceling Circuit
- Built-in UVLO Functions for All Channels

Description

The FAN73892 is a monolithic three-phase half-bridge gate-drive IC designed for high-voltage, high-speed, driving MOSFETs and IGBTs operating up to +600 V.

Fairchild's high-voltage process and common-mode noise-canceling technique provide stable operation of high-side drivers under high-dv/dt noise circumstances.

An advanced level-shift circuit allows high-side gate driver operation up to $V_S = -9.8$ V (typical) for $V_{BS} = 15$ V.

The protection functions include under-voltage lockout and inverter over-current trip with an automatic fault-clear function. Over-current protection that terminates all six outputs can be derived from an external current-sense resistor. An open-drain fault signal is provided to indicate that an over-current or under-voltage shutdown has occurred. The UVLO circuits prevent malfunction when V_{DD} and V_{BS} are lower than the threshold voltage.

Output drivers typically source and sink 350 mA and 650 mA, respectively; which is suitable for three-phase half-bridge applications in motor drive systems.

Applications

- 3-Phase Motor Inverter Driver
- Air Conditioner, Washing Machine, Refrigerator, Dish Washer
- Industrial Inverter – Sewing Machine, Power Tool
- General-Purpose Three-Phase Inverter

28-SOIC



Ordering Information

| Part Number | Package | Operating Temperature | Packing Method |
|---------------------------|---|-----------------------|----------------|
| FAN73892MX ⁽¹⁾ | 28-Lead, Small Outline Integrated Circuit, (SOIC) | -40 to +125°C | Tape & Reel |

Note:

1. These devices passed wave-soldering test by JESD22A-111.

Typical Application Diagram

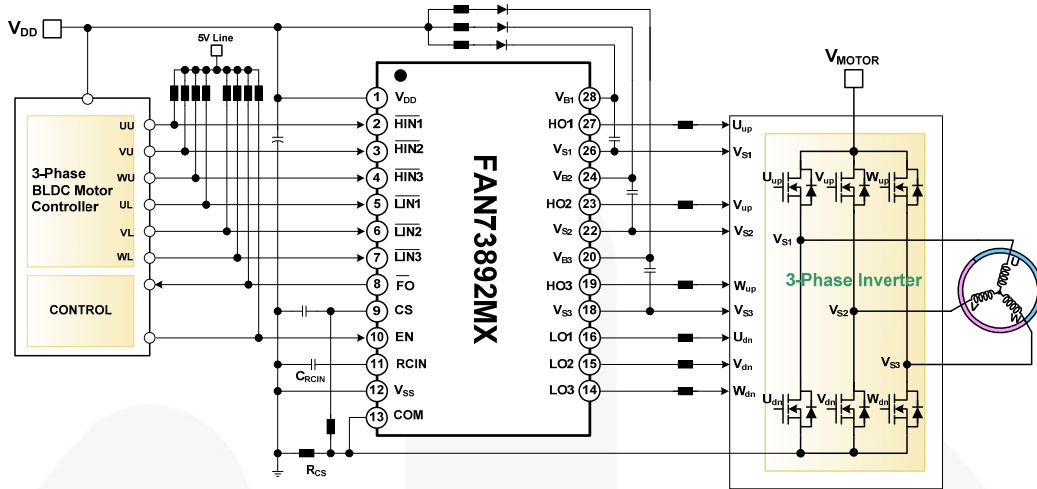

Figure 1. 3-Phase BLDC Motor Drive Application

Internal Block Diagram

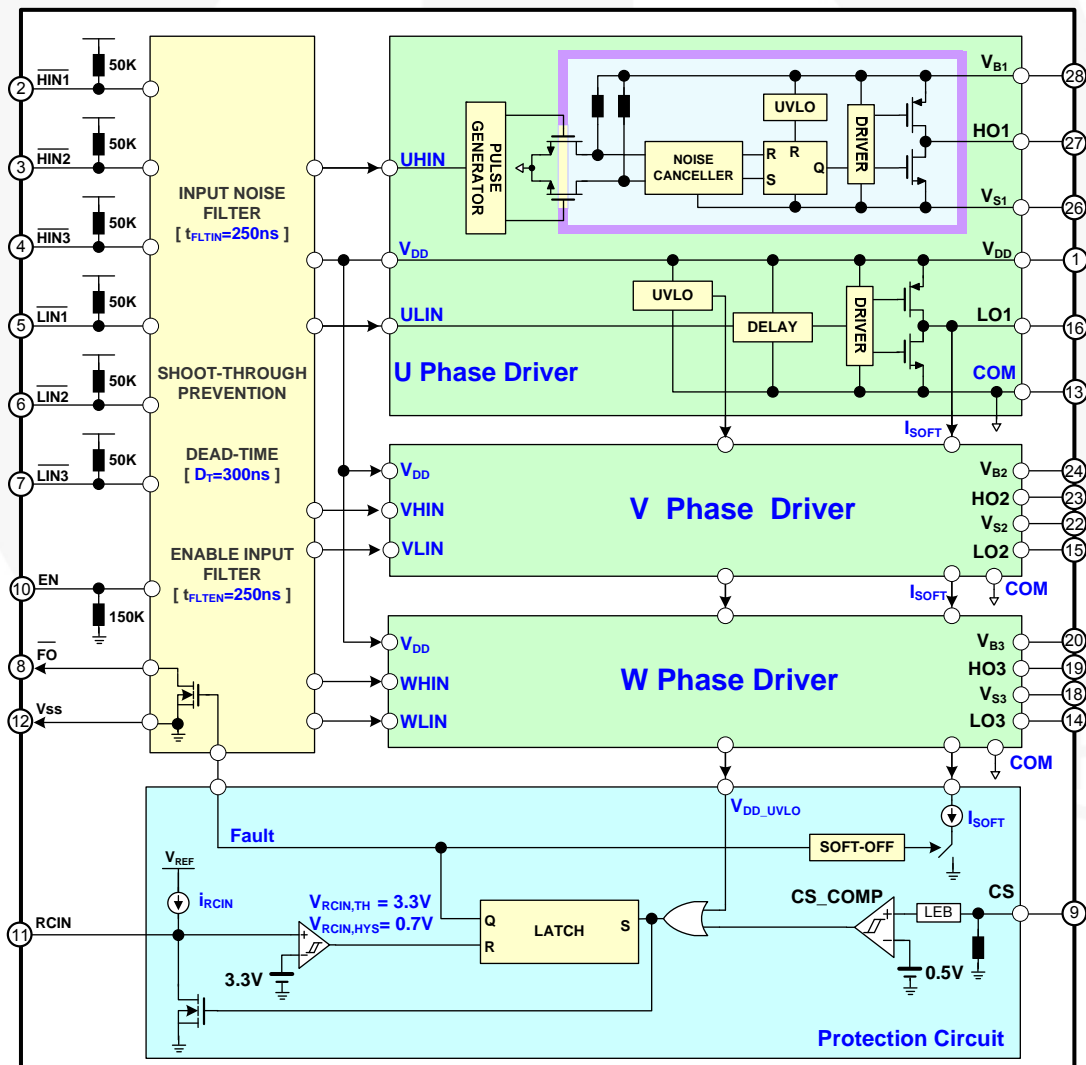

Figure 2. Functional Block Diagram

Pin Configuration

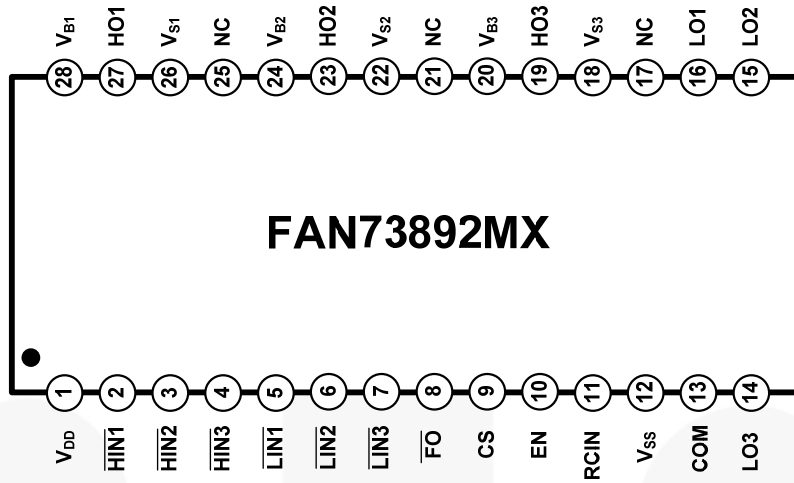

Figure 3. Pin Assignments

Pin Definitions

| Pin | Name | Description |
|------------|-------------------|--|
| 1 | V_{DD} | Logic and low-side gate driver power supply voltage |
| 2 | $\overline{HIN1}$ | Logic Input 1 for high-side gate 1 driver |
| 3 | $\overline{HIN2}$ | Logic Input 2 for high-side gate 2 driver |
| 4 | $\overline{HIN3}$ | Logic Input 3 for high-side gate 3 driver |
| 5 | $\overline{LIN1}$ | Logic Input 1 for low-side gate 1 driver |
| 6 | $\overline{LIN2}$ | Logic Input 2 for low-side gate 2 driver |
| 7 | $\overline{LIN3}$ | Logic Input 3 for low-side gate 3 driver |
| 8 | \overline{FO} | Fault output with open drain (indicates over-current and low-side under-voltage) |
| 9 | CS | Analog input for over-current shutdown |
| 10 | EN | Logic input for shutdown functionality |
| 11 | RCIN | An external RC network input used to define the fault-clear delay |
| 12 | V_{SS} | Logic ground |
| 13 | COM | Low-side driver return |
| 14 | LO3 | Low-side gate driver 3 output |
| 15 | LO2 | Low-side gate driver 2 output |
| 16 | LO1 | Low-side gate driver 1 output |
| 17, 21, 25 | NC | No connect |
| 18 | V_{S3} | High-side driver 3 floating supply offset voltage |
| 19 | HO3 | High-side driver 3 gate driver output |
| 20 | V_{B3} | High-side driver 3 floating supply |
| 22 | V_{S2} | High-side driver 2 floating supply offset voltage |
| 23 | HO2 | High-side driver 2 gate driver output |
| 24 | V_{B2} | High-side driver 2 floating supply |
| 26 | V_{S1} | High-side driver 1 floating supply offset voltage |
| 27 | HO1 | High-side driver 1 gate driver output |
| 28 | V_{B1} | High-side driver 1 floating supply |

Absolute Maximum Ratings

Stresses exceeding the Absolute Maximum Ratings may damage the device. The device may not function or be operable above the recommended operating conditions and stressing the parts to these levels is not recommended. In addition, extended exposure to stresses above the recommended operating conditions may affect device reliability. The absolute maximum ratings are stress ratings only. $T_A=25^{\circ}\text{C}$, unless otherwise specified.

| Symbol | Parameter | Min. | Max. | Unit |
|---------------|---|------------------|------------------|-----------------------------|
| V_S | High-Side Floating Offset Voltage | $V_{B1,2,3}-25$ | $V_{B1,2,3}+0.3$ | V |
| V_B | High-Side Floating Supply Voltage | -0.3 | 625.0 | V |
| V_{DD} | Low-Side and Logic-Fixed supply voltage | -0.3 | 25.0 | V |
| V_{HO} | High-Side Floating Output Voltage $V_{HO1,2,3}$ | $V_{S1,2,3}-0.3$ | $V_{B1,2,3}+0.3$ | V |
| V_{LO} | Low-Side Floating Output Voltage $V_{LO1,2,3}$ | -0.3 | $V_{DD}+0.3$ | V |
| V_{IN} | Input Voltage ($HINx$, $LINx$, CS, and EN) | -0.3 | 5.5 | V |
| V_{FO} | Fault Output Voltage (\overline{FO}) | -0.3 | $V_{DD}+0.3$ | V |
| PW_{HIN} | High-Side Input Pulse Width | 500 | | ns |
| dV_S/dt | Allowable Offset Voltage Slew Rate | | ± 50 | V/ns |
| P_D | Power Dissipation ^(2,3) | | 1.4 | W |
| θ_{JA} | Thermal Resistance | | 70 | $^{\circ}\text{C}/\text{W}$ |
| T_J | Junction Temperature | | 150 | $^{\circ}\text{C}$ |
| T_{STG} | Storage Temperature | -55 | 150 | $^{\circ}\text{C}$ |

Notes:

- Mounted on 76.2 x 114.3 x 1.6mm PCB (FR-4 glass epoxy material). Refer to the following standards:
JESD51-2: Integral circuit's thermal test method environmental conditions, natural convection;
JESD51-3: Low effective thermal conductivity test board for leaded surface-mount packages.
- Do not exceed maximum power dissipation (P_D) under any circumstances.

Recommended Operating Conditions

The Recommended Operating Conditions table defines the conditions for actual device operation. Recommended operating conditions are specified to ensure optimal performance to the datasheet specifications. Fairchild does not recommend exceeding them or designing to Absolute Maximum Ratings.

| Symbol | Parameter | Min. | Max. | Unit |
|---------------|---|-----------------|-----------------|--------------------|
| $V_{B1,2,3}$ | High-Side Floating Supply Voltage | $V_{S1,2,3}+10$ | $V_{S1,2,3}+20$ | V |
| $V_{S1,2,3}$ | High-Side Floating Supply Offset Voltage | $6-V_{DD}$ | 600 | V |
| V_{DD} | Low-Side and Logic Fixed Supply Voltage | 10 | 20 | V |
| $V_{HO1,2,3}$ | High-Side Output Voltage | $V_{S1,2,3}$ | $V_{B1,2,3}$ | V |
| $V_{LO1,2,3}$ | Low-Side Output Voltage | COM | V_{DD} | V |
| V_{FO} | Fault Output Voltage (\overline{FO}) | V_{SS} | V_{DD} | V |
| V_{CS} | Current-Sense Pin Input Voltage | V_{SS} | 5 | V |
| V_{IN} | Logic Input Voltage ($HIN1,2,3$ and $LIN1,2,3$) | V_{SS} | 5 | V |
| V_{SS} | Logic Ground | -5 | 5 | V |
| T_A | Ambient Temperature | -40 | +125 | $^{\circ}\text{C}$ |

Electrical Characteristics

V_{BIAS} (V_{DD} , $V_{BS1,2,3}$) = 15.0 V and T_A = 25°C unless otherwise specified. The V_{IN} and I_{IN} parameters are referenced to COM and are applicable to all six channels. The V_O and I_O parameters are referenced to $V_{S1,2,3}$ and COM and are applicable to the respective output leads: HO1,2,3 and LO1,2,3. The V_{DDUV} parameters are referenced to COM. The V_{BSUV} parameters are referenced to $V_{S1,2,3}$.

| Symbol | Parameter | Condition | Min. | Typ. | Max. | Unit |
|--|---|--|------|------|------|------------|
| Low-Side Power Supply Section | | | | | | |
| I_{QDD} | Quiescent V_{DD} Supply Current | $V_{LIN1,2,3}=0$ V or 5 V, EN=0 V | | 200 | | μ A |
| I_{PDD} | Operating V_{DD} Supply Current | $f_{LIN1,2,3}=20$ kHz, rms Value | | 500 | | μ A |
| V_{DDUV+} | V_{DD} Supply Under-Voltage Positive-Going Threshold | $V_{DD}=\text{Sweep}$ | 7.5 | 8.5 | 9.3 | V |
| V_{DDUV-} | V_{DD} Supply Under-Voltage Negative-Going Threshold | $V_{DD}=\text{Sweep}$ | 7.0 | 8.0 | 8.7 | V |
| V_{DDHYS} | V_{DD} Supply Under-Voltage Lockout Hysteresis | $V_{DD}=\text{Sweep}$ | | 0.5 | | V |
| Bootstrapped Power Supply Section | | | | | | |
| V_{BSUV+} | V_{BS} Supply Under-Voltage Positive-Going Threshold | $V_{BS1,2,3}=\text{Sweep}$ | 7.5 | 8.5 | 9.3 | V |
| V_{BSUV-} | V_{BS} Supply Under-Voltage Negative-Going Threshold | $V_{BS1,2,3}=\text{Sweep}$ | 7.0 | 8.0 | 8.7 | V |
| V_{BSHYS} | V_{BS} Supply Under-Voltage Lockout Hysteresis | $V_{BS1,2,3}=\text{Sweep}$ | | 0.5 | | V |
| I_{LK} | Offset Supply Leakage Current | $V_{B1,2,3}=V_{S1,2,3}=600$ V | | | 10 | μ A |
| I_{QBS} | Quiescent V_{BS} Supply Current | $V_{HIN1,2,3}=0$ V or 5 V, EN=0 V | 10 | 50 | 80 | μ A |
| I_{PBS} | Operating V_{BS} Supply Current | $f_{HIN1,2,3}=20$ kHz, rms Value | 200 | 320 | 480 | μ A |
| Gate Driver Output Section | | | | | | |
| V_{OH} | High-Level Output voltage, $V_{BIAS}-V_O$ | $I_O=0$ mA (No Load) | | | 100 | mV |
| V_{OL} | Low-Level Output voltage, V_O | $I_O=0$ mA (No Load) | | | 100 | mV |
| I_{O+} | Output HIGH Short-Circuit Pulse Current ⁽⁴⁾ | $V_O=15$ V, $V_{IN}=0$ V with $PW \leq 10$ μ s | 250 | 350 | | mA |
| I_{O-} | Output LOW Short-Circuit Pulsed Current ⁽⁴⁾ | $V_O=0$ V, $V_{IN}=5$ V with $PW \leq 10$ μ s | 500 | 650 | | mA |
| V_S | Allowable Negative V_S Pin Voltage for HIN Signal Propagation to HO | | | -9.8 | -7.0 | V |
| Logic Input Section | | | | | | |
| V_{IH} | Logic "0" Input Voltage $\overline{HIN1,2,3}$, $\overline{LIN1,2,3}$ | | 2.5 | | | V |
| V_{IL} | Logic "1" Input Voltage $HIN1,2,3$, $LIN1,2,3$ | | | | 0.8 | V |
| I_{IN+} | Logic Input Bias Current (HO=LO=HIGH) | $V_{IN}=0$ V | | 100 | | μ A |
| I_{IN-} | Logic Input Bias Current (HO=LO=LOW) | $V_{IN}=5$ V | | 8.5 | 25 | μ A |
| R_{IN} | Logic Input Pull-Up Resistance | | | 50 | | K Ω |
| Enable Control Section (EN) | | | | | | |
| V_{EN+} | Enable Positive-Going Threshold Voltage | | 2.5 | | | V |
| V_{EN-} | Enable Negative-Going Threshold Voltage | | | | 0.8 | V |
| I_{EN+} | Logic Enable "1" Input Bias Current | $V_{EN}=5$ V (Pull-Down=150K Ω) | | 33 | | μ A |
| I_{EN-} | Logic Enable "0" Input Bias Current | $V_{EN}=0$ V | | | 2 | μ A |

Continued on the following page...

Electrical Characteristics

V_{BIAS} (V_{DD} , $V_{BS1,2,3}$) = 15.0 V and T_A = 25°C unless otherwise specified. The V_{IN} and I_{IN} parameters are referenced to COM and are applicable to all six channels. The V_O and I_O parameters are referenced to $V_{S1,2,3}$ and COM and are applicable to the respective output leads: HO1,2,3 and LO1,2,3. The V_{DDUV} parameters are referenced to COM. The V_{BSUV} parameters are referenced to $V_{S1,2,3}$.

| Symbol | Parameter | Condition | Min. | Typ. | Max. | Unit |
|--|---|--|------|------|------|------|
| Over-Current Protection Section | | | | | | |
| V_{CSTH+} | Over-Current Detect Positive Threshold ⁽⁴⁾ | | 400 | 500 | 600 | mV |
| V_{CSTH-} | Over-Current Detect Negative Threshold ⁽⁴⁾ | | | 440 | | mV |
| V_{CSHYS} | Over-Current Detect Hysteresis ⁽⁴⁾ | | | 60 | | mV |
| I_{CSIN} | Short-Circuit Input Current | $V_{CSIN}=1\text{ V}$ | 5 | 10 | 15 | μA |
| I_{SOFT} | Soft Turn-Off Sink Current | | 25 | 40 | 55 | mA |
| Fault Output Section | | | | | | |
| $V_{RCINTH+}$ | RCIN Positive-Going Threshold Voltage | | | 3.3 | | V |
| $V_{RCINTH-}$ | RCIN Negative-Going Threshold Voltage | | | 2.6 | | V |
| $V_{RCINHYS}$ | RCIN Hysteresis Voltage | | | 0.7 | | V |
| I_{RCIN} | RCIN Internal Current Source | $C_{RCIN}=2\text{ nF}$ | 3 | 5 | 7 | μA |
| V_{FOL} | Fault Output Low Level Voltage | $V_{CS}=1\text{ V}$, $I_{FO}=1.5\text{ mA}$ | | 0.2 | 0.5 | V |
| R_{DSRCIN} | RCIN On Resistance | $I_{RCIN}=1.5\text{ mA}$ | 50 | 75 | 100 | Ω |
| R_{DSFO} | Fault Output On Resistance | $I_{FO}=1.5\text{ mA}$ | 90 | 130 | 170 | Ω |

Note:

4. These parameters are guaranteed by design.

Dynamic Electrical Characteristics

$T_A=25^\circ\text{C}$, V_{BIAS} (V_{DD} , $V_{BS1,2,3}$) = 15.0 V, $V_{S1,2,3}$ = COM, $C_{RCIN}=2\text{ nF}$, and C_{Load} = 1000 pF unless otherwise specified.

| Symbol | Parameter | Conditions | Min. | Typ. | Max. | Unit |
|--------------|---|--|------|------|------|------|
| t_{ON} | Turn-On Propagation Delay | $V_{LIN1,2,3}=V_{HIN1,2,3}=5\text{ V}$, $V_{S1,2,3}=0\text{ V}$ | 350 | 500 | 650 | ns |
| t_{OFF} | Turn-Off Propagation Delay | $V_{LIN1,2,3}=V_{HIN1,2,3}=0\text{ V}$, $V_{S1,2,3}=0\text{ V}$ | 350 | 500 | 650 | ns |
| t_R | Turn-On Rise Time | $V_{LIN1,2,3}=V_{HIN1,2,3}=5\text{ V}$ | 20 | 50 | 100 | ns |
| t_F | Turn-Off Fall Time | $V_{LIN1,2,3}=V_{HIN1,2,3}=0\text{ V}$ | 10 | 30 | 80 | ns |
| t_{EN} | Enable LOW to Output Shutdown Delay | | 400 | 500 | 600 | ns |
| t_{CSBLT} | CS Pin Leading-Edge Blanking Time ⁽⁵⁾ | | 200 | 300 | 400 | ns |
| t_{CSFO} | Time from CS Triggering to \overline{FO} ⁽⁶⁾ | From $V_{CSC}=1\text{ V}$ to \overline{FO} Turn-Off | | 630 | | ns |
| t_{CSOFF} | Time from CS Triggering to All Gate Outputs Turn-Off ⁽⁶⁾ | From $V_{CSC}=1\text{ V}$ to Starting Gate Turn-Off | | 640 | | ns |
| t_{FLTIN} | Input Filtering Time ⁽⁷⁾ (\overline{HINx} , \overline{LINx} , EN) | | 200 | 250 | 300 | ns |
| t_{FLTCLR} | Fault-Clear Time | | | 1.3 | | ms |
| DT | Dead Time | | 230 | 290 | 350 | ns |
| MDT | Dead-Time Matching (All Six Channels) | | | | 50 | ns |
| MT | Delay Matching (All Six Channels) | | | | 50 | ns |
| PM | Output Pulse-Width Matching ^(5,8) | $PW_{IN} > 1\text{ }\mu\text{s}$ | | 50 | 100 | ns |

Notes:

- These parameters are guaranteed by design.
- These parameters are referenced to specified $C_{RCIN}(=2\text{ nF})$, and proportional to value of C_{RCIN} as shown in Figure 43. It is strongly recommended that the capacitor on R_{CIN} pin should be less than 5 nF.
- The minimum width of the input pulse should exceed 500 ns to ensure the filtering time of the input filter is exceeded.
- PM is defined as $PW_{IN}-PW_{OUT}$.

Typical Characteristics

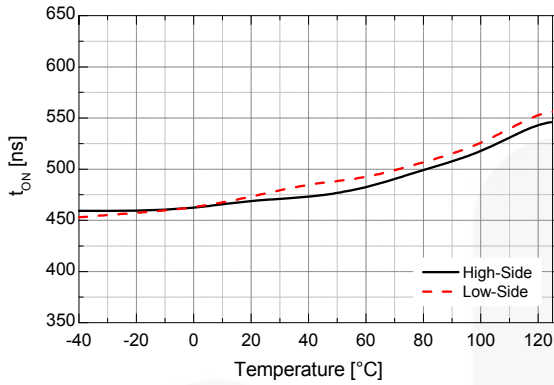

Figure 4. Turn-On Propagation Delay vs. Temperature

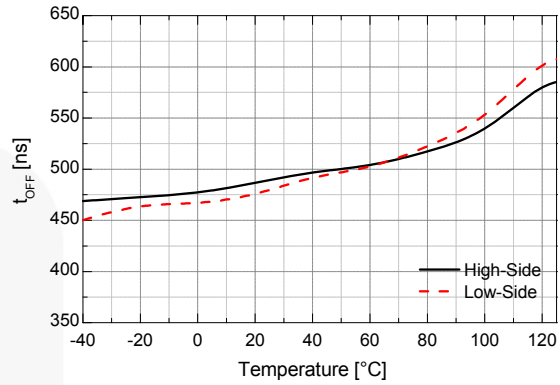

Figure 5. Turn-Off Propagation Delay vs. Temperature

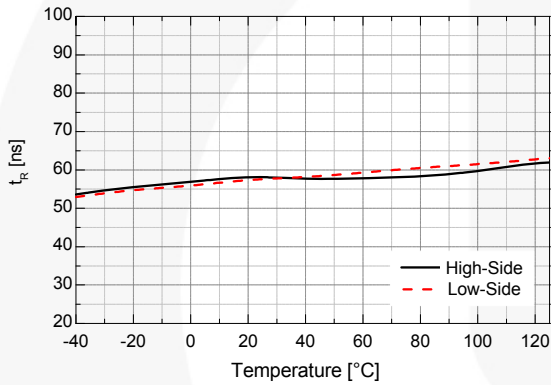

Figure 6. Turn-On Rise Time vs. Temperature

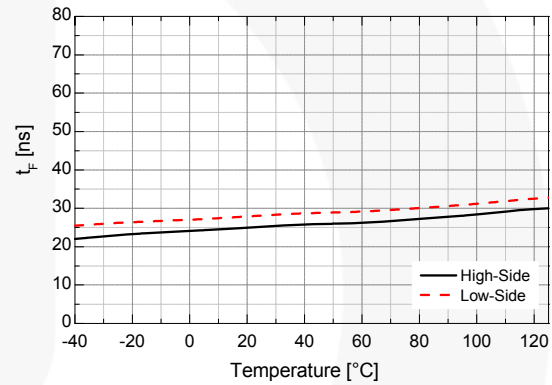

Figure 7. Turn-Off Fall Time vs. Temperature

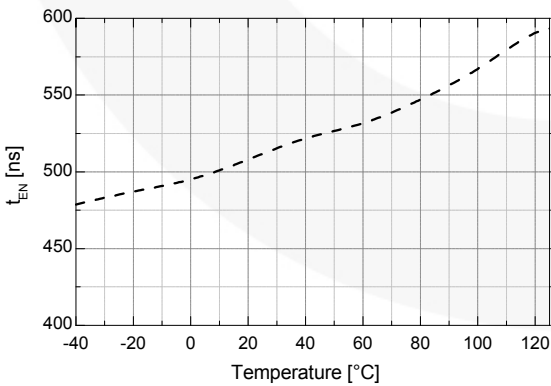

Figure 8. Enable LOW to Output Shutdown Delay vs. Temperature

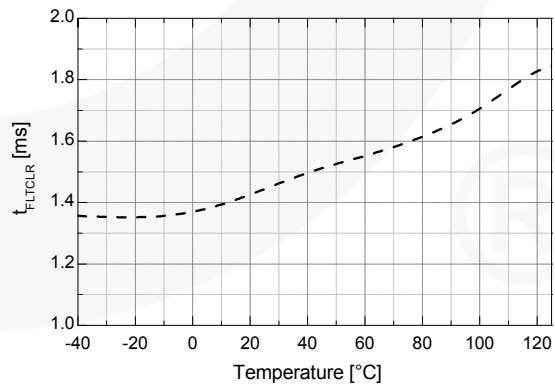

Figure 9. Fault-Clear Time vs. Temperature

Typical Characteristics (Continued)

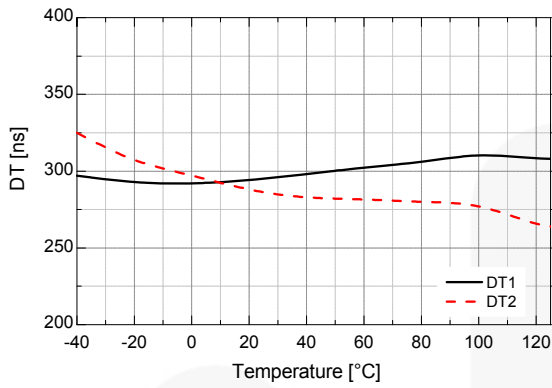

Figure 10. Dead Time vs. Temperature

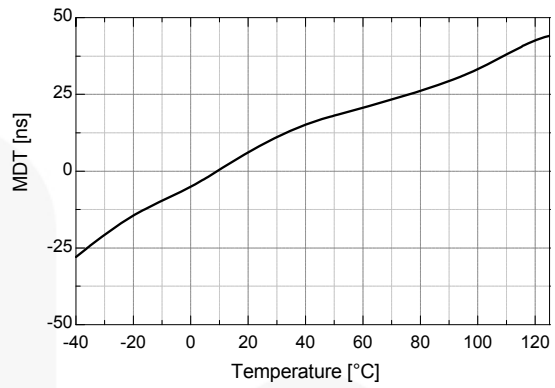

Figure 11. Dead-Time Matching vs. Temperature

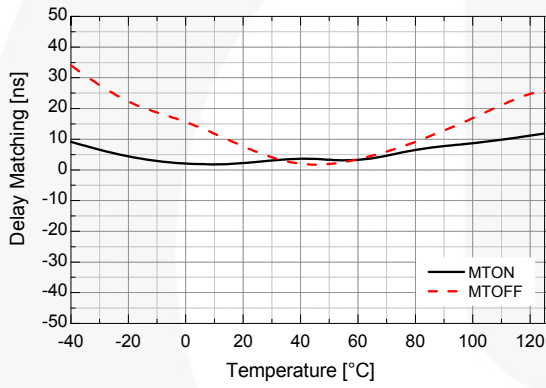

Figure 12. Delay Matching vs. Temperature

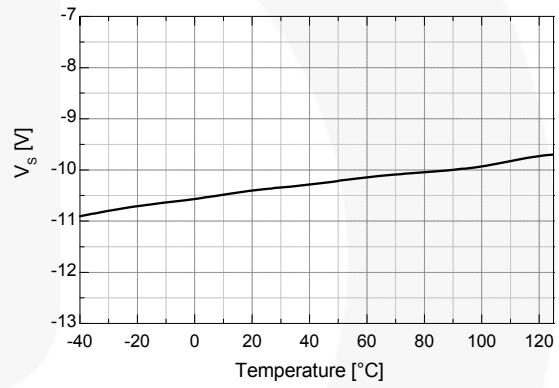

Figure 13. Allowable Negative V_S Voltage vs. Temperature

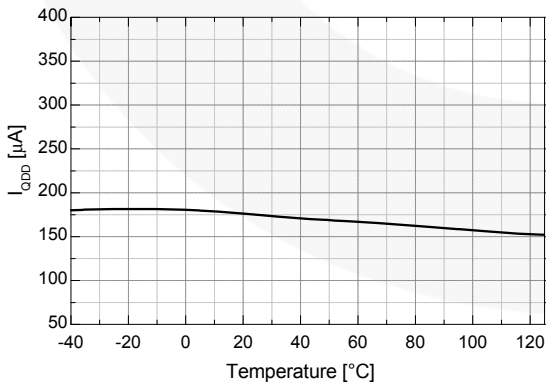

Figure 14. Quiescent V_{DD} Supply Current vs. Temperature

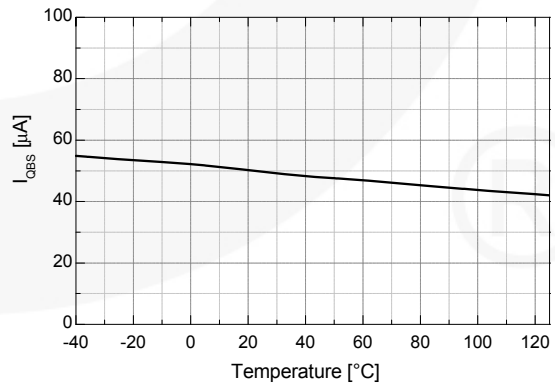

Figure 15. Quiescent V_{BS} Supply Current vs. Temperature

Typical Characteristics (Continued)

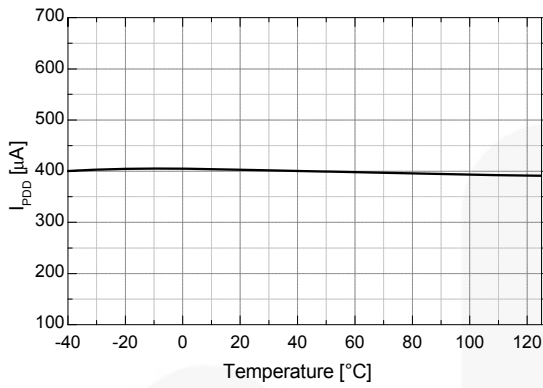

Figure 16. Operating V_{DD} Supply Current vs. Temperature

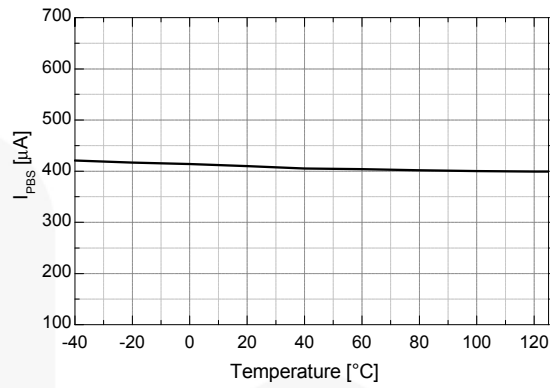

Figure 17. Operating V_{BS} Supply Current vs. Temperature

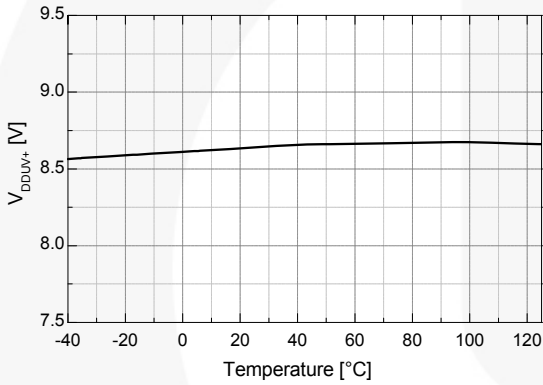

Figure 18. V_{DD} UVLO+ vs. Temperature

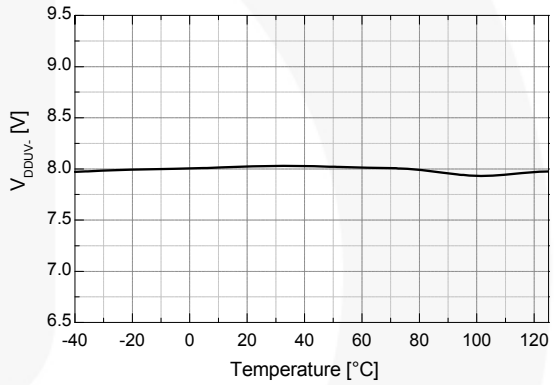

Figure 19. V_{DD} UVLO- vs. Temperature

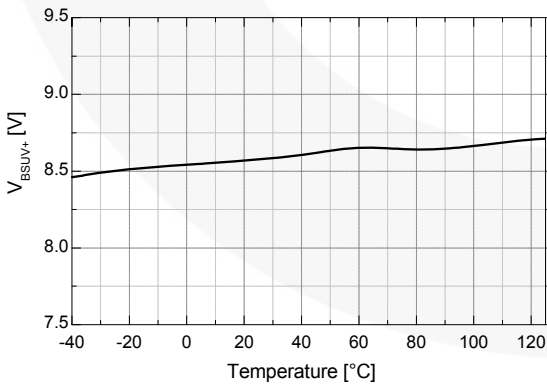

Figure 20. V_{BS} UVLO+ vs. Temperature

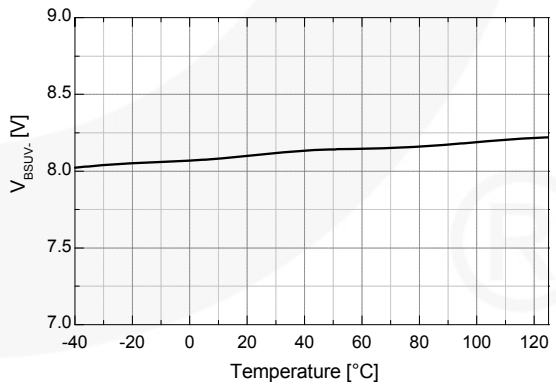

Figure 21. V_{BS} UVLO- vs. Temperature

Typical Characteristics (Continued)

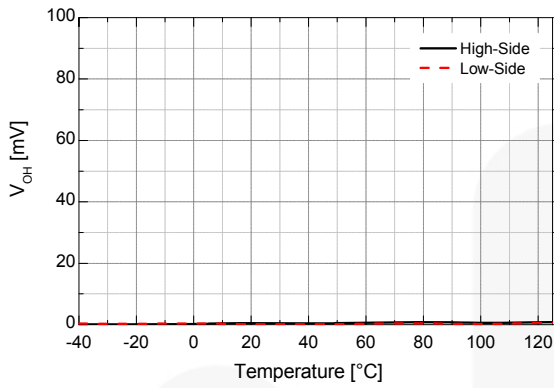

Figure 22. High-Level Output Voltage vs. Temperature

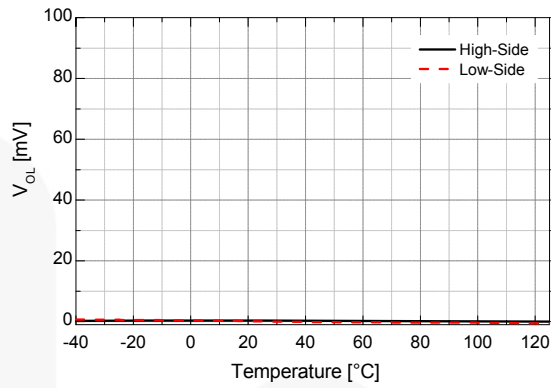

Figure 23. Low-Level Output Voltage vs. Temperature

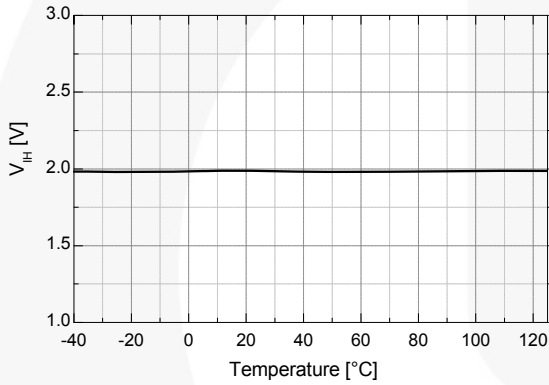

Figure 24. Logic HIGH Input Voltage vs. Temperature

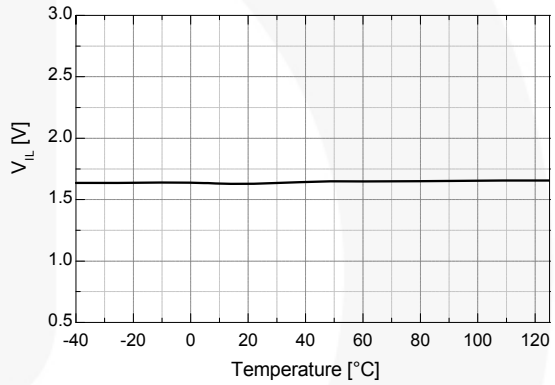

Figure 25. Logic LOW Input Voltage vs. Temperature

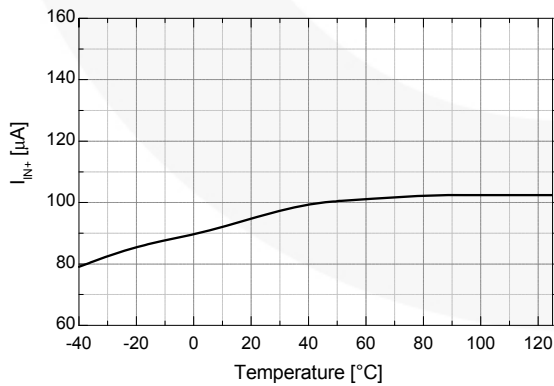

Figure 26. Logic Input HIGH Bias Current vs. Temperature

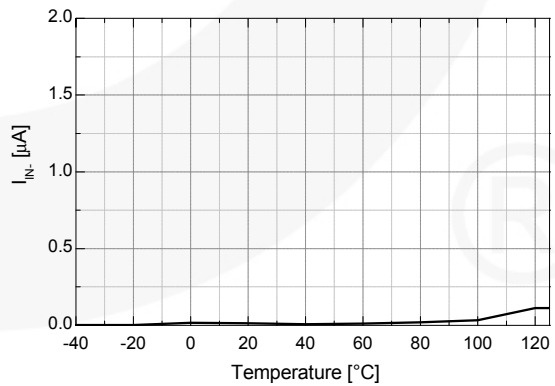

Figure 27. Logic Input LOW Bias Current vs. Temperature

Typical Characteristics (Continued)

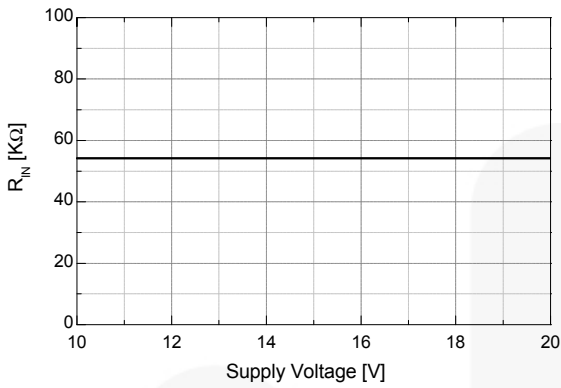

Figure 28. Input Pull-Down Resistance vs. Supply Voltage

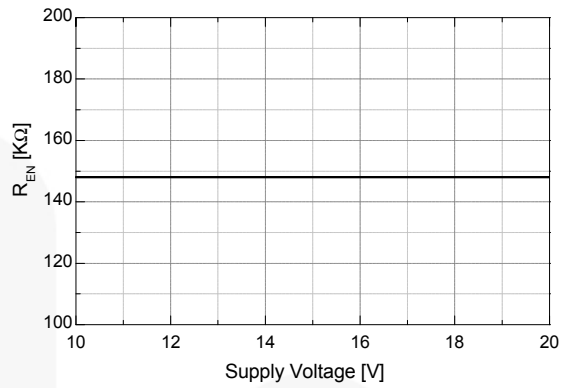

Figure 29. Enable Pin Pull-Down Resistance vs. Supply Voltage

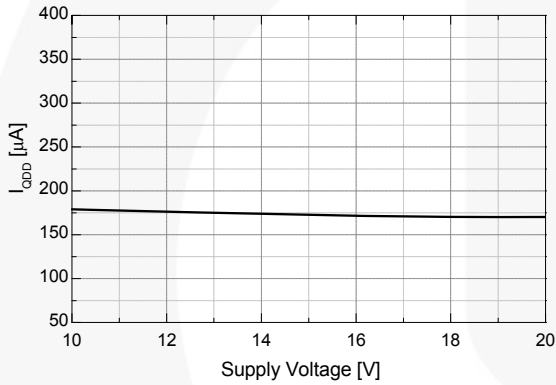

Figure 30. Quiescent V_{DD} Supply Current vs. Supply Voltage

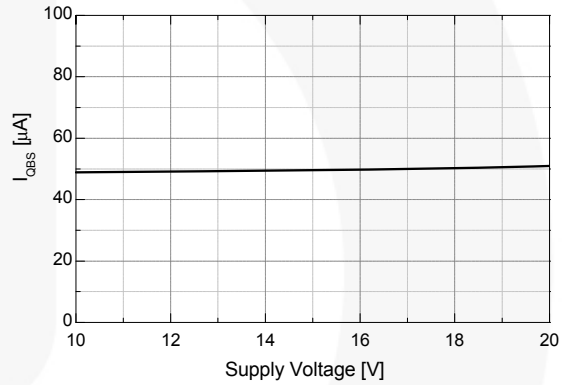

Figure 31. Quiescent V_{BS} Supply Current vs. Supply Voltage

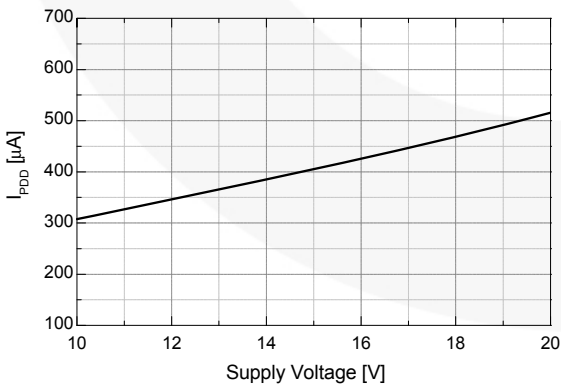

Figure 32. Operating V_{DD} Supply Current vs. Supply Voltage

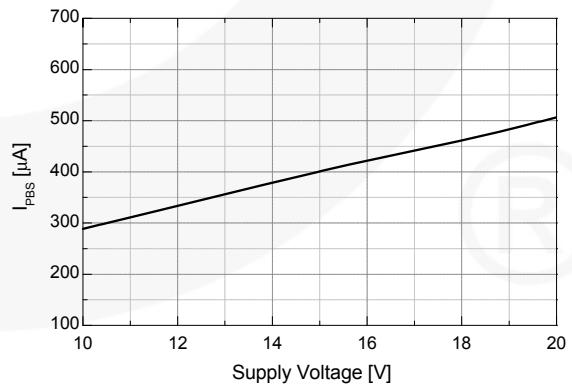

Figure 33. Operating V_{BS} Supply Current vs. Supply Voltage

Switching Time Definitions

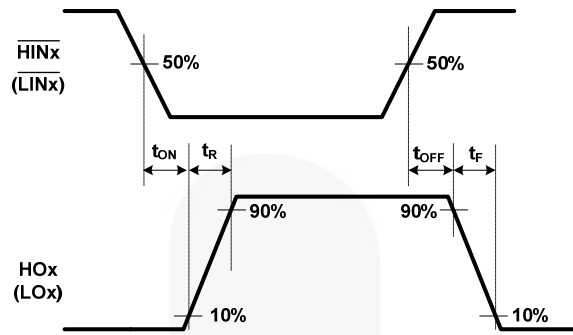

Figure 34. Switching Time Waveform Definitions

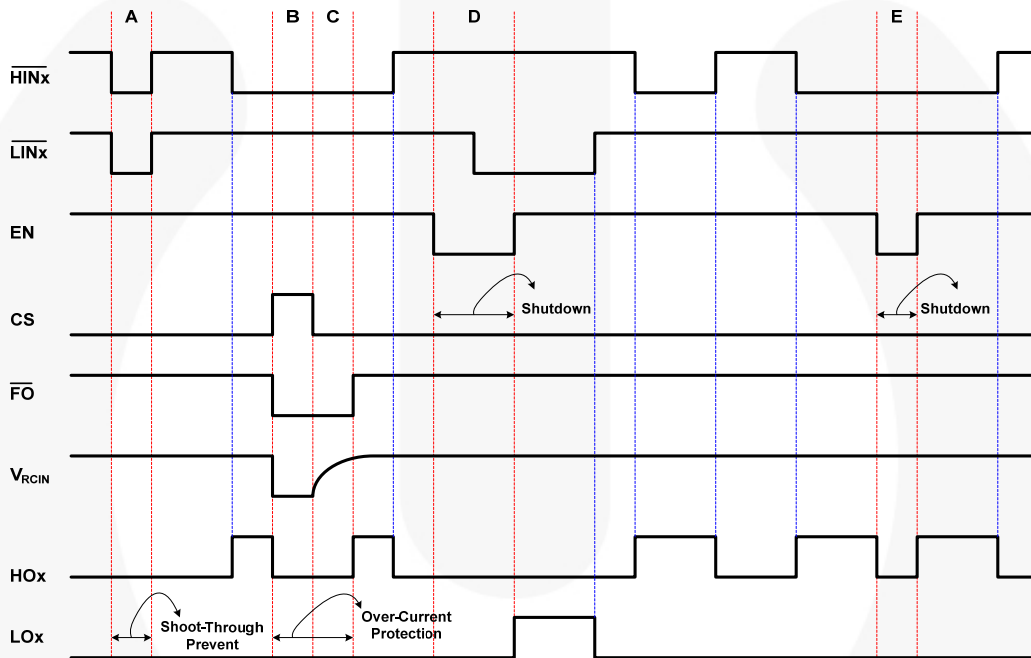

Figure 35. Input / Output Timing Diagram

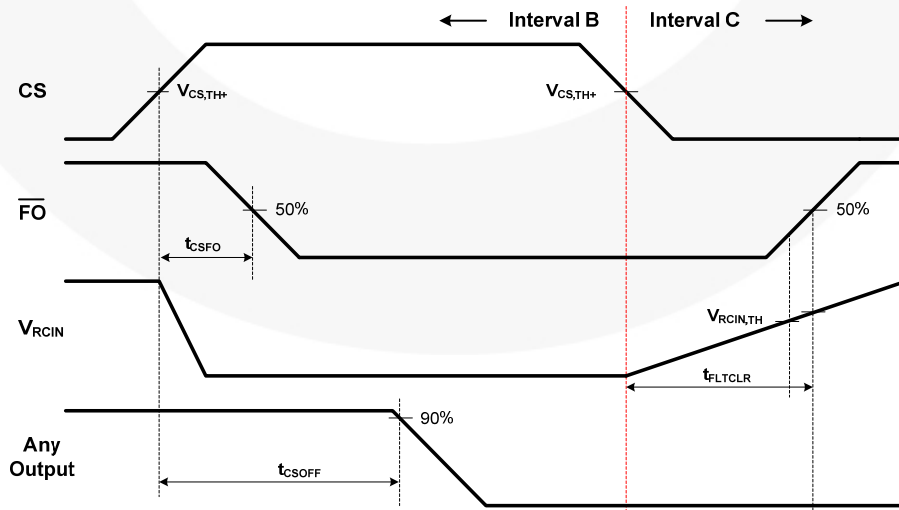

Figure 36. Detailed View of B and C Intervals During Over-Current Protection

Applications Information

1. Dead Time

Dead time is automatically inserted whenever the dead time of the external two input signals (between HINx and LINx signals) is shorter than internal fixed dead times (DT1 and DT2). Otherwise, external dead times larger than internal dead times are not modified by the gate driver and internal dead-time waveform definition is shown in Figure 37.

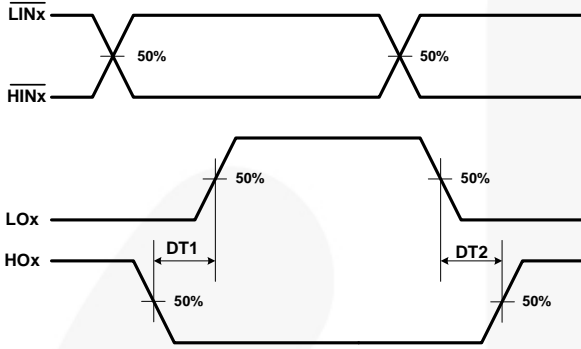

Figure 37. Internal Dead-Time Definitions

2. Protection Function

2.1 Fault Out (FO) and Under-Voltage Lockout

The high- and low-side drivers include under-voltage lockout (UVLO) protection circuitry that monitors the supply voltage for V_{DD} and V_{BS} independently. It can be designed to prevent malfunction when V_{DD} and V_{BS} are lower than the specified threshold voltage. The UVLO hysteresis prevents chattering during power-supply transitions. Moreover, the fault signal (power supply voltage FO) goes to LOW state to operate reliably during power-on events when the power supply (V_{DD}) is below the under-voltage lockout high threshold voltage for the circuit (during t₁ ~ t₂). The UVLO circuit is not otherwise activated; shown Figure 38.

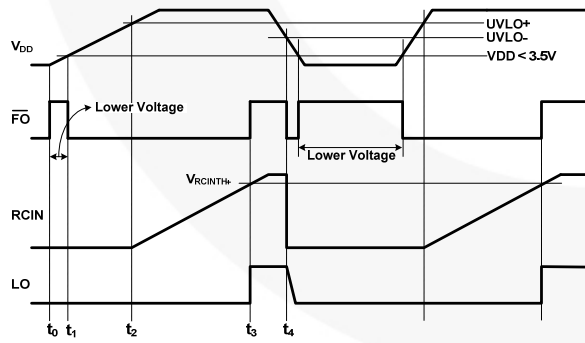

Figure 38. Waveforms for Under-Voltage Lockout

2.2 Shoot-Through Protection

The shoot-through protection circuitry prevents both high- and low-side switches from conducting at the same time, as shown Figure 39.

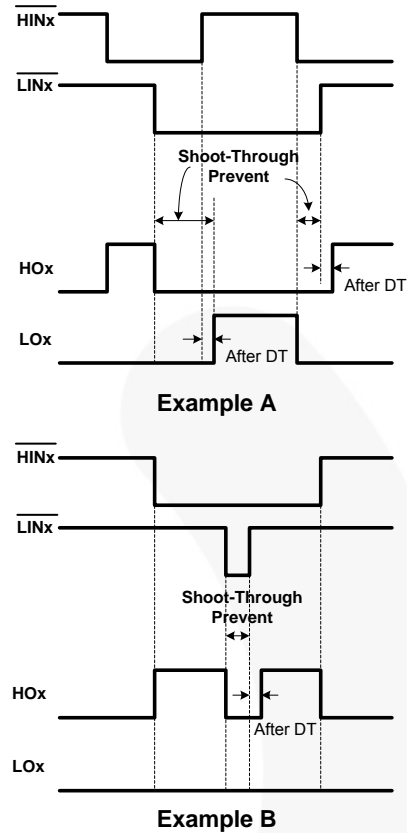

Figure 39. Shoot-Through Protection

2.3 Enable Input

When the EN pin is in HIGH state, the gate driver operates normally. When a condition occurs that should shut down the gate driver, the EN pin should be LOW. The enable circuitry has an input filter; the minimum input duration is specified by t_{FLTIN} (typically 250 ns).

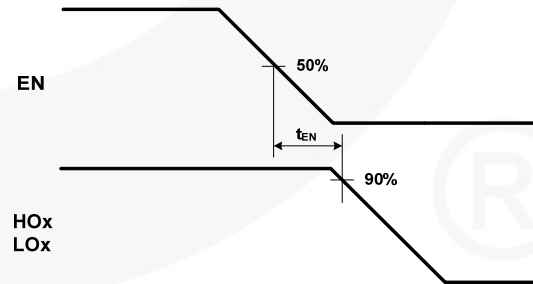

Figure 40. Output Enable Timing Waveform

2.4 Fault-Out (\overline{FO}) and Over-Current Protection

FAN73892 provides an integrated fault output (\overline{FO}) and an adjustable fault-clear timer (t_{FLTCLR}). There are two situations that cause the gate driver to report a fault via the \overline{FO} pin. The first is an under-voltage condition of low-side gate driver supply voltage (V_{DD}) and the second is when the current-sense pin (CS) recognizes a fault. If a fault condition occurs, the \overline{FO} pin is internally pulled to COM, the fault-clear timer is activated, and all outputs (HO1, 2, 3 and LO1, 2, 3) of the gate driver are turned off. The fault output stays LOW until the fault condition has been removed and the fault-clear timer expires. Once the fault-clear timer expires, the voltage on the \overline{FO} pin returns to pull-up voltage.

The fault-clear time (t_{FLTCLR}) is determined by an internal current source ($I_{RCIN}=5\ \mu A$) and an external C_{RCIN} at the RCIN pin, as shown as:

$$t_{FLTCLR} = \frac{C_{RCIN} \times V_{RCIN,TH}}{I_{RCIN}} \quad [s] \quad (1)$$

The R_{DSRCIN} of the MOSFET is a characteristic discharge curve with respect to the external capacitor C_{RCIN} . The time constant is defined by the external capacitor C_{RCIN} and the R_{DSRCIN} of the MOSFET.

The output of current-sense comparator (CS_COMP) passes a noise filter, which inhibits an over-current shutdown caused by parasitic voltage spikes of V_{CS} .

This corresponds to a voltage level at the comparator of $V_{CSTH+} - V_{CSHYS} = 500\ mV - 60\ mV = 440\ mV$, where $V_{CSHYS}=60\ mV$ is the hysteresis of the current comparator (CS_COMP), as shown in Figure 41.

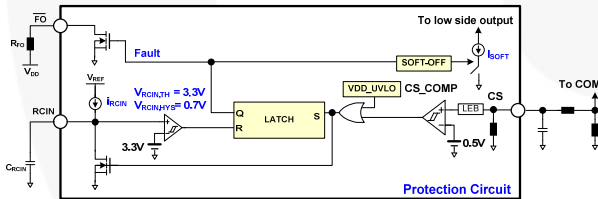

Figure 41. Over-Current Protection

Figure 42 shows the waveform definitions of RCIN, \overline{FO} , and the low-side driver; which uses a soft turn-off method when an under-voltage condition of the low-side gate driver supply voltage (V_{DD}) or the current-sense pin (CS) recognizes a fault. If a fault condition occurs, the \overline{FO} Pin is internally pulled to COM and all outputs (HO1,2,3 and LO1,2,3) of the gate driver are turned off. Low-side outputs decline linearly by the internal sink current source ($I_{SOFT}=40mA$) for soft turn-off, as shown in Figure 42.

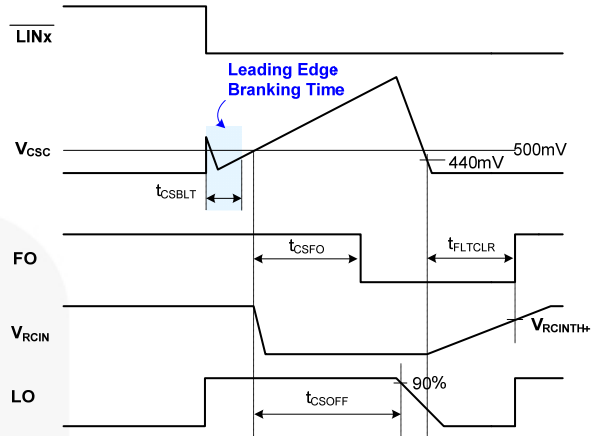

Figure 42. RCIN and Fault-Clear Waveform Definition

2.5 Recommended C_{RCIN}

Figure 43 shows timing of t_{CSOFF} and t_{CSFO} vs. C_{RCIN} .

It is strongly recommended that the capacitor on R_{CIN} pin should be less than 5 nF in order to properly protect power devices in over-current situations.

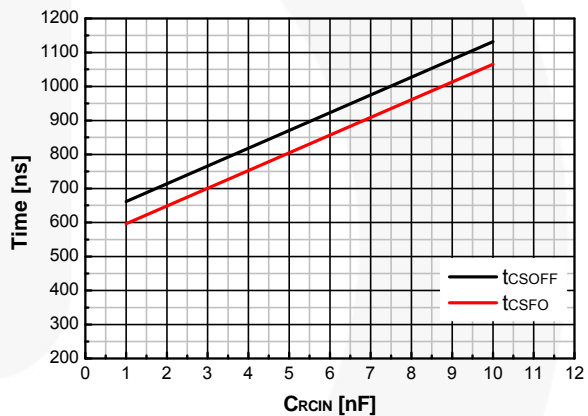

Figure 43. Timing of t_{CSOFF} and t_{CSFO} vs. C_{RCIN}

3. Noise Filter

3.1 Input Noise Filter

Figure 44 shows the input noise filter method, which has symmetry duration between the input signal (t_{INPUT}) and the output signal (t_{OUTPUT}) and helps to reject noise spikes and short pulses. This input filter is applied to the HINx, LINx, and EN inputs. The upper pair of waveforms (Example A) shows an input signal duration (t_{INPUT}) much longer than input filter time (t_{FLTIN}); it is approximately the same duration between the input signal time (t_{INPUT}) and the output signal time (t_{OUTPUT}). The lower pair of waveforms (Example B) shows an input signal time (t_{INPUT}) slightly longer than input filter time (t_{FLTIN}); it is approximately the same duration between input signal time (t_{INPUT}) and the output signal time (t_{OUTPUT}).

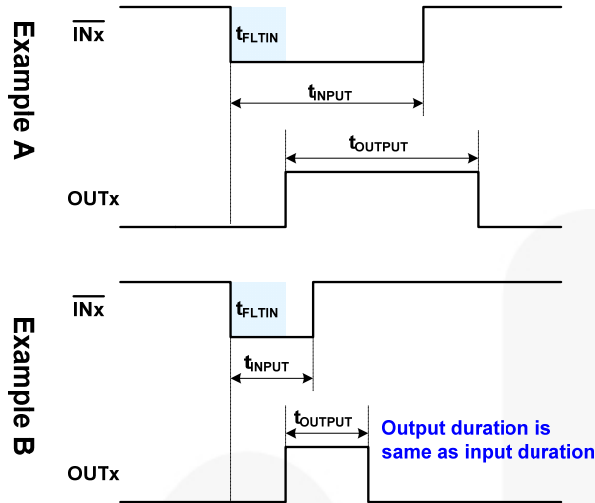

Figure 44. Input Noise Filter Definition

3.2. Short-Pulsed Input Noise Rejection Method

The input filter circuitry provides protection against short-pulsed input signals ($HINx$, $LINx$, and EN) on the input signal lines by applied noise signal.

If the input signal duration is less than input filter time (t_{FLTIN}), the output does not change states.

Example A and B of the Figure 45 show the input and output waveforms with short-pulsed noise spikes with a duration less than input filter time; the output does not change states.

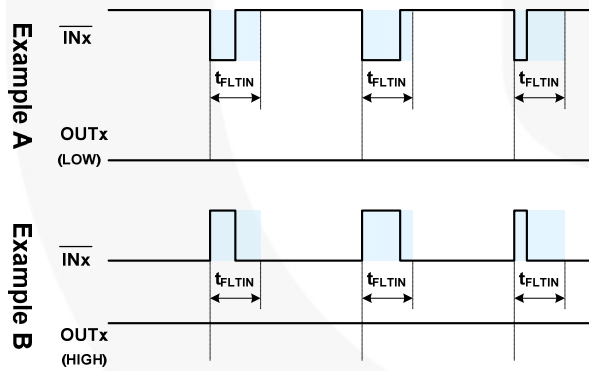

Figure 45. Noise Rejecting Input Filter Definition

Figure 46 shows the characteristics of the input filters while receiving narrow ON and OFF pulses. If input signal pulse duration, PW_{IN} , is less than input filter time, t_{FLTIN} ; the output pulse, PW_{OUT} , is zero. The input signal is rejected by input filter. Once the input signal pulse duration, PW_{IN} , exceeds input filter time, t_{FLTIN} , the output pulse durations, PW_{OUT} , matches the input pulse durations, PW_{IN} . FAN73892 input filter time, t_{FLTIN} , is about 250 ns for the high- and low-side outputs.

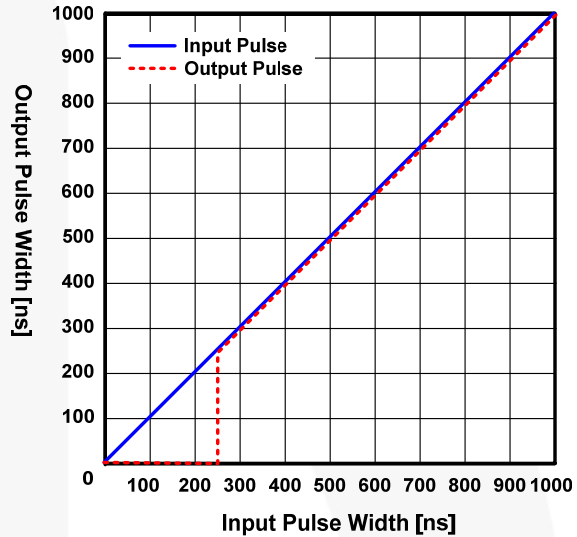

Figure 46. Input Filter Characteristic of Narrow ON

Package Dimensions

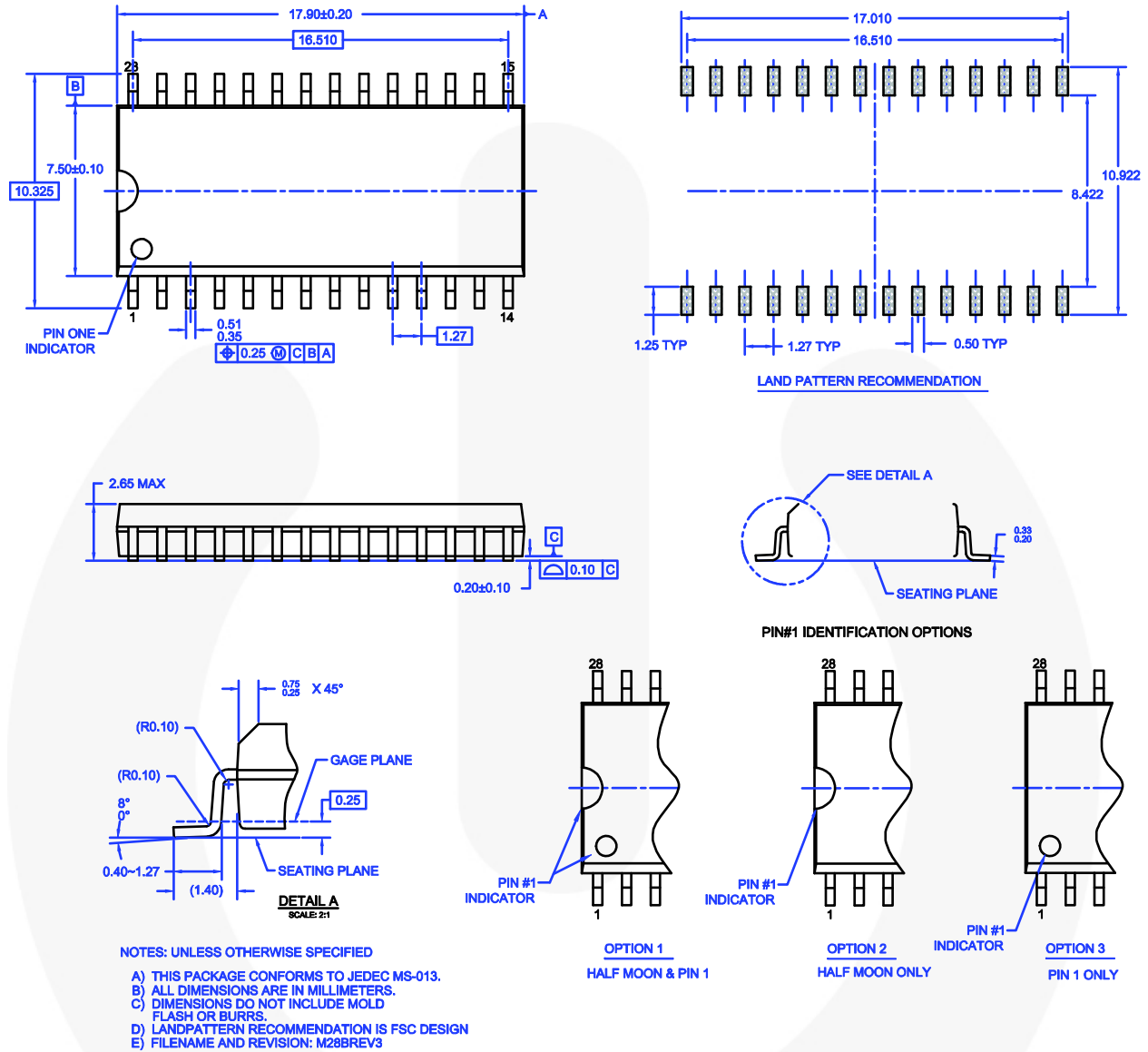

Figure 47. 28-Lead, Small Outline Integrated Circuit, (28 Wide-Body SOIC)

Package drawings are provided as a service to customers considering Fairchild components. Drawings may change in any manner without notice. Please note the revision and/or date on the drawing and contact a Fairchild Semiconductor representative to verify or obtain the most recent revision. Package specifications do not expand the terms of Fairchild's worldwide terms and conditions, specifically the warranty therein, which covers Fairchild products.

Always visit Fairchild Semiconductor's online packaging area for the most recent package drawings:
<http://www.fairchildsemi.com/packaging/>.



TRADEMARKS

The following includes registered and unregistered trademarks and service marks, owned by Fairchild Semiconductor and/or its global subsidiaries, and is not intended to be an exhaustive list of all such trademarks.

| | | | |
|--|--|---|---|
| 2Cool™ | F-PFS™ | PowerTrench® | The Power Franchise® |
| AccuPower™ | FRFET® | PowerXS™ |  |
| AX-CAP™* | Global Power Resource™ | Programmable Active Droop™ | TinyBoost™ |
| BitSiC™ | GreenBridge™ | QFET® | TinyBuck™ |
| Build it Now™ | Green FPST™ | QS™ | TinyCalc™ |
| CorePLUS™ | Green FPST™ e-Series™ | Quiet Series™ | TinyLogic® |
| CorePOWER™ | Gmax™ | RapidConfigure™ | TINYOPTO™ |
| CROSSVOLT™ | GTO™ |  | TinyPower™ |
| CTL™ | IntelliMAX™ | Saving our world, 1mV/W/kW at a time™ | TinyPWM™ |
| Current Transfer Logic™ | ISOPLANAR™ | SignalWise™ | TinyWire™ |
| DEUXPEED® | Making Small Speakers Sound Louder and Better™ | SmartMax™ | TranSiC™ |
| Dual Cool™ | MegaBuck™ | SMART START™ | TriFault Detect™ |
| EcoSPARK® | MICROCOUPLER™ | Solutions for Your Success™ | TRUECURRENT®* |
| EfficientMax™ | MicroFET™ | SPM® | μSerDes™ |
| ESBCT™ | MicroPak™ | STEALTH™ |  |
|  Fairchild® | MicroPak2™ | SuperFET® | UHC® |
| Fairchild Semiconductor® | MillerDrive™ | SuperSOT™-3 | Ultra FRFET™ |
| FACT Quiet Series™ | MotionMax™ | SuperSOT™-6 | UniFET™ |
| FACT® | mVSAver™ | SuperSOT™-8 | VoltagePlus™ |
| FAST® | OptoHiT™ | SupreMOS® | XS™ |
| FastvCore™ | OPTOLOGIC® | SyncFET™ | |
| FETBench™ | OPTOPLANAR® | Sync-Lock™ | |
| FPST™ | |  | |

* Trademarks of System General Corporation, used under license by Fairchild Semiconductor.

DISCLAIMER

FAIRCHILD SEMICONDUCTOR RESERVES THE RIGHT TO MAKE CHANGES WITHOUT FURTHER NOTICE TO ANY PRODUCTS HEREIN TO IMPROVE RELIABILITY, FUNCTION, OR DESIGN. FAIRCHILD DOES NOT ASSUME ANY LIABILITY ARISING OUT OF THE APPLICATION OR USE OF ANY PRODUCT OR CIRCUIT DESCRIBED HEREIN; NEITHER DOES IT CONVEY ANY LICENSE UNDER ITS PATENT RIGHTS, NOR THE RIGHTS OF OTHERS. THESE SPECIFICATIONS DO NOT EXPAND THE TERMS OF FAIRCHILD'S WORLDWIDE TERMS AND CONDITIONS, SPECIFICALLY THE WARRANTY THEREIN, WHICH COVERS THESE PRODUCTS.

LIFE SUPPORT POLICY

FAIRCHILD'S PRODUCTS ARE NOT AUTHORIZED FOR USE AS CRITICAL COMPONENTS IN LIFE SUPPORT DEVICES OR SYSTEMS WITHOUT THE EXPRESS WRITTEN APPROVAL OF FAIRCHILD SEMICONDUCTOR CORPORATION.

As used herein:

1. Life support devices or systems are devices or systems which, (a) are intended for surgical implant into the body or (b) support or sustain life, and (c) whose failure to perform when properly used in accordance with instructions for use provided in the labeling, can be reasonably expected to result in a significant injury of the user.
2. A critical component in any component of a life support, device, or system whose failure to perform can be reasonably expected to cause the failure of the life support device or system, or to affect its safety or effectiveness.

ANTI-COUNTERFEITING POLICY

Fairchild Semiconductor Corporation's Anti-Counterfeiting Policy. Fairchild's Anti-Counterfeiting Policy is also stated on our external website, www.fairchildsemi.com, under Sales Support.

Counterfeiting of semiconductor parts is a growing problem in the industry. All manufacturers of semiconductor products are experiencing counterfeiting of their parts. Customers who inadvertently purchase counterfeit parts experience many problems such as loss of brand reputation, substandard performance, failed applications, and increased cost of production and manufacturing delays. Fairchild is taking strong measures to protect ourselves and our customers from the proliferation of counterfeit parts. Fairchild strongly encourages customers to purchase Fairchild parts either directly from Fairchild or from Authorized Fairchild Distributors who are listed by country on our web page cited above. Products customers buy either from Fairchild directly or from Authorized Fairchild Distributors are genuine parts, have full traceability, meet Fairchild's quality standards for handling and storage and provide access to Fairchild's full range of up-to-date technical and product information. Fairchild and our Authorized Distributors will stand behind all warranties and will appropriately address any warranty issues that may arise. Fairchild will not provide any warranty coverage or other assistance for parts bought from Unauthorized Sources. Fairchild is committed to combat this global problem and encourage our customers to do their part in stopping this practice by buying direct or from authorized distributors.

PRODUCT STATUS DEFINITIONS

Definition of Terms

| Datasheet Identification | Product Status | Definition |
|--------------------------|-----------------------|---|
| Advance Information | Formative / In Design | Datasheet contains the design specifications for product development. Specifications may change in any manner without notice. |
| Preliminary | First Production | Datasheet contains preliminary data; supplementary data will be published at a later date. Fairchild Semiconductor reserves the right to make changes at any time without notice to improve design. |
| No Identification Needed | Full Production | Datasheet contains final specifications. Fairchild Semiconductor reserves the right to make changes at any time without notice to improve the design. |
| Obsolete | Not In Production | Datasheet contains specifications on a product that is discontinued by Fairchild Semiconductor. The datasheet is for reference information only. |

Rev. 163