

# Integrated Automotive TFT-LCD Power Supply Regulator

## ISL78419

The ISL78419 is an integrated power management IC (PMIC) for TFT-LCDs used in central display, rear seat entertainment and virtual dashboards. The device integrates a boost converter for generating  $A_{VDD}$ , an LDO regulator for VLOGIC.  $V_{ON}$  and  $V_{OFF}$  are generated by a charge pump driven by the switch node of the boost converter. The ISL78419 also includes a  $V_{ON}$  slice circuit, reset function, and a high performance VCOM amplifier with a Digitally Controlled Potentiometer (DCP) that is used as a VCOM calibrator.

The AVDD boost converter features a 1.5A/0.18Ω boost FET with 600kHz/1200kHz switching frequency.

The integrated logic LDO includes a 350mA FET for driving the low voltage needed by external digital circuitry.

The gate pulse modulator can control the gate voltage up to 30V, and both the rate and slew delay times are selectable.

The supply monitor generates a reset signal when the system is powered down based on a user selected threshold level (programming resistor).

The ISL78419 provides a digitally controlled VCOM output using I<sup>2</sup>C interface. One VCOM amplifier is also integrated in the chip to provide a fast slewing 150mA drive (sourcing or sinking). The output of the VCOM is powered up with the voltage stored at the last programmed 8-bit (internal) EEPROM setting.

The ISL78419 is rated to operate over the temperature range of (-40°C to +105°C) and is qualified according to AEC - Q100.

## Features

- 2.5V to 5.5V input
- 1.5A, 0.18Ω integrated boost FET
- $V_{ON}/V_{OFF}$  supplies generated by charge pumps driven by the boost switch node
- LDO for VLOGIC channel
- 600kHz/1200kHz selectable switching frequency
- Integrated gate pulse modulator
- Reset signal generated by supply monitor
- Integrated VCOM amplifier
- DCP
  - I<sup>2</sup>C serial interface, address: 0101000, MSB left
  - Wiper position stored in 8-bit nonvolatile memory and recalled on power-up
  - Endurance, 1,000 data changes per bit
- UVLO, UVP, OVP, OCP, and OTP protection
- Pb-free (RoHS compliant)
- 28 Ld 4x5 QFN
- AEC - Q100 qualified

## Applications

- Automotive TFT displays
  - Central displays, rear seat entertainment and dashboards

## Pin Configuration

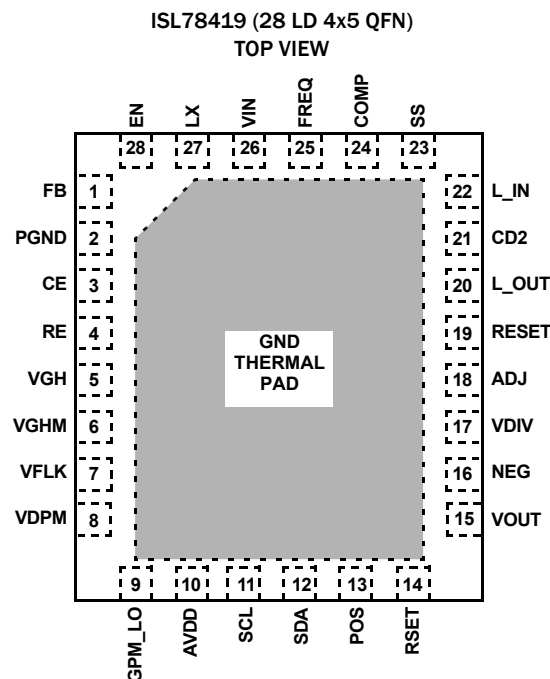

## Application Diagram

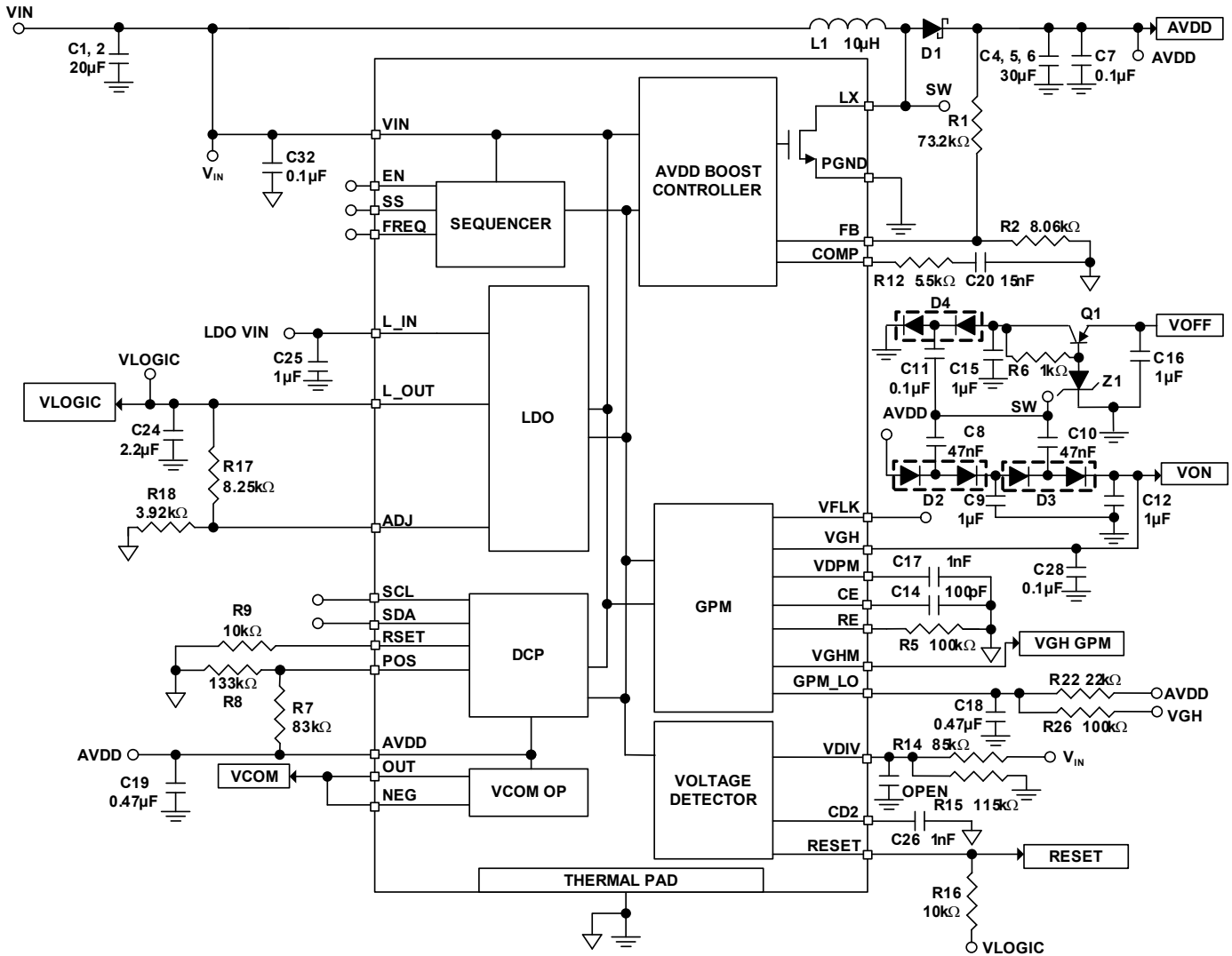

## Pin Descriptions

PIN#	SYMBOL	DESCRIPTION
1	FB	AVDD boost converter feedback. Connect to the center of a voltage divider between AVDD and GND to set the AVDD voltage.
2	PGND	Power ground
3	CE	Gate Pulse Modulator Delay Control. Connect a capacitor between this pin and GND to set the delay time.
4	RE	Gate Pulse Modulator Slew Control. Connect a resistor between this pin and GND to set the falling slew rate.
5	VGH	Gate Pulse Modulator High Voltage Input. Place a 0.1µF decoupling capacitor close to the VGH pin.
6	VGHM	Gate Pulse Modulator Output for gate driver IC
7	VFLK	Gate Pulse Modulator Control input from T <sub>CON</sub>
8	VDPM	Gate Pulse Modulator Enable. Connect a capacitor from VDPM to GND to set the delay time before GPM is enabled. A current source charges the capacitor on VDPM.
9	GPM_LO	Gate Pulse Modulator Low Voltage Input; place a 0.47µF decoupling capacitor close to the GPM_LO pin.
10	AVDD	DCP and VCOM amplifier high voltage analog supply; place a 0.47µF decoupling capacitor close to the AVDD pin.
11	SCL	I <sup>2</sup> C compatible clock input

# ISL78419

## Pin Descriptions (Continued)

PIN#	SYMBOL	DESCRIPTION
12	SDA	I <sup>2</sup> C compatible serial bidirectional data line
13	POS	VCOM Amplifier Non-inverting input
14	RSET	DCP sink current adjustment pin; connect a resistor between this pin and GND to set the resolution of the DCP output voltage.
15	VOUT	VCOM Amplifier output
16	NEG	VCOM Amplifier inverting input
17	VDIV	Voltage detector threshold. Connect to the center of a resistive divider between V <sub>IN</sub> and GND.
18	ADJ	VLOGIC LDO feedback. Connect to the center of a resistive divider between L_OUT and GND to set V <sub>Logic</sub> voltage for T <sub>CON</sub> .
19	RESET	Voltage detector reset output
20	L_OUT	LDO output. Connect at least one 1μF capacitor to GND for stable operation.
21	CD2	Voltage detector rising edge delay. Connect a capacitor between this pin and GND to set the rising edge delay.
22	L_IN	LDO input. Connect a 1μF decoupling capacitor close to this pin.
23	SS	Boost Converter Soft-Start. Connect a capacitor between this pin and GND to set the soft-start time.
24	COMP	Boost converter compensation pin. Connect a series resistor and capacitor between this pin and GND to optimize transient response and stability.
25	FREQ	Boost Converter frequency select; pull it to logic high to operate boost at 1.2MHz. Connect this pin to GND to operate boost at 600kHz.
26	VIN	IC input supply. Connect a 0.1μF decoupling capacitor close to this pin.
27	LX	AVDD boost converter switching node
28	EN	AVDD enable pin

## Ordering Information

PART NUMBER (Notes 1, 2, 3)	PART MARKING	V <sub>IN</sub> RANGE (V)	TEMP RANGE (°C)	PACKAGE (Pb-free)	PKG. DWG. #
ISL78419ARZ	78419 ARZ	2.5 to 5.5	-40 to +105	28 Ld 4x5 QFN	L28.4x5A

### NOTES:

1. Add "-T\*" suffix for tape and reel. Please refer to [TB347](#) for details on reel specifications.
2. These Intersil Pb-free plastic packaged products employ special Pb-free material sets, molding compounds/die attach materials, and 100% matte tin plate plus anneal (e3 termination finish, which is RoHS compliant and compatible with both SnPb and Pb-free soldering operations). Intersil Pb-free products are MSL classified at Pb-free peak reflow temperatures that meet or exceed the Pb-free requirements of IPC/JEDEC J STD-020.
3. For Moisture Sensitivity Level (MSL), please see device information page for [ISL78419](#) For more information on MSL please see techbrief [TB363](#).

## Table of Contents

<b>Absolute Maximum Ratings</b> .....	<b>5</b>
<b>Thermal Information</b> .....	<b>5</b>
<b>Recommended Operating Conditions</b> .....	<b>5</b>
<b>Electrical Specifications</b> .....	<b>5</b>
<b>Serial Interface Specifications</b> .....	<b>7</b>
<b>Typical Performance Curves</b> .....	<b>9</b>
<b>Applications Information</b> .....	<b>11</b>
Enable Control .....	11
Frequency Selection .....	11
Soft-Start .....	11
Operation .....	11
Capacitor .....	11
Inductor .....	11
Rectifier Diode .....	11
Output Capacitor .....	12
Compensation .....	12
Linear Regulator (LDO) .....	12
Supply Monitor Circuit .....	12
Gate Pulse Modulator Circuit .....	13
VCOM Amplifier .....	13
DCP Memory Description .....	13
I <sup>2</sup> C Serial Interface .....	14
Protocol Conventions .....	14
Write Operation .....	15
Data Protection .....	15
Read Operation .....	16
Communication with ISL78419 .....	16
Register Description: Access Control .....	16
Register Description: IVR and WR .....	16
Initial VCOM Setting .....	17
Start-up Sequence .....	17
Layout Recommendation .....	17
<b>Revision History</b> .....	<b>19</b>
<b>About Intersil</b> .....	<b>19</b>
<b>Package Outline Drawing</b> .....	<b>20</b>

# ISL78419

## Absolute Maximum Ratings

RE, VGHM, GPM_LO and VGH to GND	-0.3 to +36V
LX, AVDD, POS, NEG, VOUT to GND	-0.3 to +18V
Voltage Between GND and PGND	±0.5V
All Other Pins to GND	-0.3 to +6.0V
ESD Rating	
Human Body Model (Tested per JESD22-A114E)	2kV
Machine Model (Tested per JESD22-A115-A)	200V
Charged Device Model (Tested per JESD22-C101)	1kV
Latch Up (Tested per JESD-78B; Class 2, Level A)	100mA

## Thermal Information

Thermal Resistance (Typical)	$\theta_{JA}$ (°C/W)	$\theta_{JC}$ (°C/W)
28 Ld 4x5 QFN Package (Notes 4, 5)	38	4.5
Ambient Temperature	-40°C to +105°C	
Functional Junction Temperature	-40°C to +150°C	
Storage Temperature	-65°C to +150°C	
Lead Temperature During Soldering	+260°C	
Pb-Free Reflow Profile	see link below	
	<a href="http://www.intersil.com/pbfree/Pb-FreeReflow.asp">http://www.intersil.com/pbfree/Pb-FreeReflow.asp</a>	

## Recommended Operating Conditions

Temperature	-40°C to +105°C
Supply Voltage	2.5V to 5.5V

CAUTION: Do not operate at or near the maximum ratings listed for extended periods of time. Exposure to such conditions may adversely impact product reliability and result in failures not covered by warranty.

### NOTES:

- $\theta_{JA}$  is measured in free air with the component mounted on a high effective thermal conductivity test board with “direct attach” features. See Tech Brief [TB379](#).
- For  $\theta_{JC}$ , the “case temp” location is the center of the exposed metal pad on the package underside.

**Electrical Specifications**  $V_{IN} = \text{ENABLE} = 3.3\text{V}$ ,  $A_{VDD} = 8\text{V}$ ,  $V_{LDO} = 2.5\text{V}$ ,  $V_{ON} = 24\text{V}$ ,  $V_{OFF} = -6\text{V}$ . **Boldface limits apply over the operating temperature range, -40°C to +105°C.**

SYMBOL	PARAMETER	TEST CONDITIONS	MIN (Note 6)	TYP (Note 7)	MAX (Note 6)	UNITS
<b>GENERAL</b>						
$V_{IN}$	$V_{IN}$ Supply Voltage Range		<b>2.5</b>	3.3	<b>5.5</b>	V
$I_{S\_DIS}$	$V_{IN}$ Supply Currents when Disabled	$V_{IN} < UVLO$		390	<b>500</b>	μA
$I_S$	$V_{IN}$ Supply Currents	ENABLE = 3.3V, overdrive AVDD and VGH		0.7	<b>1.0</b>	mA
$I_{ENABLE}$	ENABLE Pin Current	ENABLE = 0V		0		μA
<b>LOGIC INPUT CHARACTERISTICS - ENABLE, FLK, SCL, SDA, FREQ</b>						
$V_{IL}$	Low Voltage Threshold				<b>0.65</b>	V
$V_{IH}$	High Voltage Threshold		<b>1.75</b>			V
$R_{IL}$	Pull-Down Resistor	Enable, FLK, FREQ	<b>0.85</b>	1.25	<b>1.65</b>	MΩ
<b>INTERNAL OSCILLATOR</b>						
$F_{OSC}$	Switching Frequencies	FREQ = low, $T_A = +25^\circ\text{C}$	550	600	650	kHz
		FREQ = high, $T_A = +25^\circ\text{C}$	1100	1200	1300	kHz
<b>AVDD BOOST REGULATOR</b>						
DAVDD/ DIOU	AVDD Load Regulation	$50\text{mA} < I_{LOAD} < 250\text{mA}$		0.2		%
DAVDD/ DVIN	AVDD Line Regulation	$I_{LOAD} = 150\text{mA}$ , $2.5\text{V} < V_{IN} < 5.5\text{V}$		0.15		%
$V_{FB}$	Feedback Voltage ( $V_{FB}$ )	$I_{LOAD} = 100\text{mA}$ , $T_A = +25^\circ\text{C}$	0.792	0.8	0.808	V
$I_{FB}$	FB Input Bias Current				<b>100</b>	nA
$r_{DS(ON)}$	Switch ON-resistance	$T_A = +25^\circ\text{C}$		180	260	mΩ
$I_{LIM}$	Switch Current Limit		<b>1.125</b>	1.5	<b>1.875</b>	A
$D_{MAX}$	Max Duty Cycle	Freq = 1.2MHz	<b>80</b>	90		%
EFF		Freq = 1.2MHz, $I_{AVDD} = 100\text{mA}$		91		%

# ISL78419

**Electrical Specifications**  $V_{IN} = \text{ENABLE} = 3.3\text{V}$ ,  $A_{VDD} = 8\text{V}$ ,  $V_{LDO} = 2.5\text{V}$ ,  $V_{ON} = 24\text{V}$ ,  $V_{OFF} = -6\text{V}$ . **Boldface limits apply over the operating temperature range,  $-40^{\circ}\text{C}$  to  $+105^{\circ}\text{C}$ .** (Continued)

SYMBOL	PARAMETER	TEST CONDITIONS	MIN (Note 6)	TYP (Note 7)	MAX (Note 6)	UNITS
<b>LDO REGULATOR</b>						
$\frac{DV_{LDO}}{DV_{IN}}$	Line Regulation	$ILDO = 1\text{mA}$ , $3.0\text{V} < V_{IN1} < 5.5\text{V}$		1		mV/V
$\frac{DV_{LDO}}{DI_{OUT}}$	Load Regulation	$1\text{mA} < ILDO < 350\text{mA}$		0.2		%
$V_{DO}$	Dropout Voltage	Output drops by 2%, $ILDO = 350\text{mA}$		225	<b>300</b>	mV
$I_{LIML}$	Current Limit	Output drops by 5%	<b>330</b>	425		mA
$V_{ADJ}$	ADJ Reference Voltage	$I_{LOAD} = 50\text{mA}$ , $T_A = +25^{\circ}\text{C}$	0.792	0.8	0.808	V
$I_{ADJ}$	ADJ Input Bias Current				<b>0.1</b>	$\mu\text{A}$
<b>GATE PULSE MODULATOR</b>						
$V_{GH}$	VGH Voltage		<b>7</b>		<b>33</b>	V
$V_{IH\_VDPM}$	VdPM Enable Threshold		<b>1.13</b>	1.215	<b>1.30</b>	V
$I_{VGH}$	VGH Input Current	VFLK = 0		125		$\mu\text{A}$
		RE = 100k $\Omega$ , VFLK = $V_{IN}$		27.5		$\mu\text{A}$
$V_{GPM\_LO}$	GPM_LO Voltage		<b>2</b>		<b>VGH-2</b>	V
$I_{GPM\_LO}$	VGPM_LO Input Current		<b>-2</b>	0.1	<b>2</b>	$\mu\text{A}$
$V_{CEth1}$	CE Threshold Voltage 1			0.6xVIN	<b>0.8xVIN</b>	V
$V_{CEth2}$	CE Threshold Voltage 2			1.215		V
$I_{CE}$	CE Current			100		$\mu\text{A}$
$R_{VGHM\_PD}$	VGHM Pull-down Resistance			1.1		k $\Omega$
$R_{ONVGH}$	VGH to VGHM On-resistance			23		$\Omega$
IDPM	VDPM Charge Current			10		$\mu\text{A}$
<b>SUPPLY MONITOR</b>						
$V_{IH\_VDIV}$	VDIV High Threshold	VDIV rising	<b>1.265</b>	1.280	<b>1.295</b>	V
$V_{IL\_VDIV}$	VDIV Low Threshold	VDIV falling	<b>1.21</b>	1.222	<b>1.234</b>	V
$V_{thCD2}$	CD2 Threshold voltage		<b>1.200</b>	1.217	<b>1.234</b>	V
$I_{CD2}$	CD2 Charge Current			10		$\mu\text{A}$
$R_{IL\_RESET}$	RESET Pull-down Resistance			650		$\Omega$
$t_{DELAY\_RESET}$	RESET Delay on the Rising Edge			121.7k*		s
<b>VCOM AMPLIFIER <math>R_{LOAD} = 10\text{k}\Omega</math>, <math>C_{LOAD} = 10\text{pF}</math>, unless otherwise stated</b>						
$I_{S\_com}$	VCOM Amplifier Supply Current			0.7	<b>1.08</b>	mA
$V_{OS}$	Offset Voltage			2.5	<b>15</b>	mV
$I_B$	Non-inverting Input Bias Current			0		nA
CMIR	Common Mode Input Voltage Range		<b>0</b>		<b>AVDD</b>	V
CMRR	Common-Mode Rejection Ratio		<b>60</b>	75		dB
PSRR	Power Supply Rejection Ratio		<b>70</b>	85		dB
$V_{OH}$	Output Voltage Swing High	$I_{OUT(\text{source})} = 0.1\text{mA}$		AVDD - 1.39		mV
		$I_{OUT(\text{source})} = 75\text{mA}$		AVDD - 1.27		V
$V_{OL}$	Output Voltage Swing Low	$I_{OUT(\text{sink})} = 0.1\text{mA}$		1.2		mV
		$I_{OUT(\text{sink})} = 75\text{mA}$		1		V

# ISL78419

**Electrical Specifications**  $V_{IN} = \text{ENABLE} = 3.3\text{V}$ ,  $A_{VDD} = 8\text{V}$ ,  $V_{LDO} = 2.5\text{V}$ ,  $V_{ON} = 24\text{V}$ ,  $V_{OFF} = -6\text{V}$ . **Boldface limits apply over the operating temperature range,  $-40^{\circ}\text{C}$  to  $+105^{\circ}\text{C}$ .** (Continued)

SYMBOL	PARAMETER	TEST CONDITIONS	MIN (Note 6)	TYP (Note 7)	MAX (Note 6)	UNITS
$I_{SC}$	Output Short Circuit Current	Pull-up	<b>150</b>	225		mA
		Pull-down	<b>150</b>	200		mA
SR	Slew Rate			25		V/ $\mu\text{s}$
BW	Gain Bandwidth	-3dB gain point		20		MHz
<b>DIGITAL CONTROLLED POTENTIOMETER</b>						
$SET_{VR}$ (Note 12)	SET Voltage Resolution			8		Bits
$SET_{DNL}$ (Notes 8, 9, 14)	SET Differential Nonlinearity	$T_A = +25^{\circ}\text{C}$			$\pm 1$	LSB
$SET_{ZSE}$ (Notes 10, 14)	SET Zero-Scale Error	$T_A = +25^{\circ}\text{C}$			$\pm 2$	LSB
$SET_{FSE}$ (Notes 11, 14)	SET Full-Scale Error	$T_A = +25^{\circ}\text{C}$			$\pm 8$	LSB
$I_{RSET}$	RSET Current				<b>100</b>	$\mu\text{A}$
AVDD to SET	AVDD to SET Voltage Attenuation			1:20		V/V
<b>FAULT DETECTION THRESHOLD</b>						
$V_{UVLO}$	Undervoltage Lock out Threshold	$PV_{IN}$ rising	<b>2.25</b>	2.33	<b>2.41</b>	V
		$PV_{IN}$ falling	<b>2.125</b>	2.20	<b>2.27</b>	V
$OVP_{AVDD}$ (Note 13)	Boost Overvoltage Protection Off Threshold to Shutdown IC		<b>15.0</b>	15.5	<b>16.0</b>	V
$T_{OFF}$	Thermal Shut-Down all Channels	Temperature rising		153		$^{\circ}\text{C}$
<b>POWER SEQUENCE TIMING</b>						
$t_{SSVLOGIC}$	VLOGIC Soft-start Time			0.45		ms
$I_{SS}$	Boost Soft-start Current		<b>3</b>	5.5	<b>8</b>	$\mu\text{A}$

## Serial Interface Specifications

For SCL and SDA Unless Otherwise Noted.

SYMBOL	PARAMETER	TEST CONDITIONS	MIN (Note 14)	TYP (Note 7)	MAX (Note 14)	UNITS
$f_{SCL}$ (Note 6)	SCL Frequency				<b>400</b>	kHz
$t_{IN}$ (Note 6)	Pulse Width Suppression Time at SDA and SCL Inputs	Any pulse narrower than the maximum specification is suppressed			<b>50</b>	ns
$t_{AA}$	SCL Falling Edge to SDA Output Data Valid	SCL falling edge crossing 30% of $V_{IN}$ , until SDA exits the 30% to 70% of $V_{IN}$ window			480	ns
$t_{BUF}$	Time the Bus Must be Free Before the Start of a New Transmission	SDA crossing 70% of $V_{CC}$ during a STOP condition, to SDA crossing 70% of $V_{IN}$ during the following START condition	480			ns
$t_{LOW}$	Clock LOW Time	Measured at the 30% of $V_{IN}$ crossing	480			ns
$t_{HIGH}$	Clock HIGH Time	Measured at the 70% of $V_{IN}$ crossing	400			ns
$t_{SU:STA}$	START Condition Set-up Time	SCL rising edge to SDA falling edge; both crossing 70% of $V_{IN}$	480			ns
$t_{HD:STA}$	START Condition Hold Time	From SDA falling edge crossing 30% of $V_{IN}$ to SCL falling edge crossing 70% of $V_{IN}$	400			ns

# ISL78419

## Serial Interface Specifications For SCL and SDA Unless Otherwise Noted. (Continued)

SYMBOL	PARAMETER	TEST CONDITIONS	MIN (Note 14)	TYP (Note 7)	MAX (Note 14)	UNITS
$t_{SU:DAT}$	Input Data Set-up Time	From SDA exiting the 30% to 70% of $V_{IN}$ window, to SCL rising edge crossing 30% of $V_{IN}$	40			ns
$t_{HD:DAT}$	Input Data Hold Time	From SCL rising edge crossing 70% of $V_{IN}$ to SDA entering the 30% to 70% of $V_{IN}$ window	0			ns
$t_{SU:STO}$	STOP Condition Set-up Time	From SCL rising edge crossing 70% of $V_{IN}$ , to SDA rising edge crossing 30% of $V_{IN}$	400			ns
$t_{HD:STO}$	STOP Condition Hold Time for Read, or Volatile Only Write	From SDA rising edge to SCL falling edge; both crossing 70% of $V_{IN}$	400			ns
$C_{SCL}$	Capacitive on SCL			5		pF
$C_{SDA}$	Capacitive on SDA			5		pF
$t_{Wp}$	Non-Volatile Write Cycle Time			25		ms
	EEPROM Endurance	$T_A = +25^\circ\text{C}$		1		kCyc
	EEPROM Retention	$T_A = +25^\circ\text{C}$		88		kHrs

### NOTES:

- Parameters with MIN and/or MAX limits are 100% tested at +25°C, unless otherwise specified. Temperature limits established by characterization and are not production tested.
- Typical values are for  $T_A = +25^\circ\text{C}$  and  $V_{IN} = 3.3\text{V}$ .
- $LSB = |V_{255} - V_1|/254$ .  $V_{255}$  and  $V_1$  are the measured voltages for the DCP register set to FF hex and 01 hex respectively.
- $DNL = |V_{i+1} - V_i|/LSB - 1$ ,  $i \in [1, 255]$
- $ZS\ error = (V_1 - V_{MIN})/LSB$ .  $V_{MIN} = (V_{AVDD} * R2) * [1 - 254 * R1 / (255 * 20 * RSET)] / (R1 + R2)$ .
- $FS\ error = (V_{255} - V_{MAX})/LSB$ .  $V_{MAX} = (V_{AVDD} * R2) * [1 - 0 * R1 / (255 * 20 * RSET)] / (R1 + R2)$ .
- Established by design. Not a parametric spec.
- Boost will stop switching as soon as boost output reaches OVP threshold.
- Compliance to limits is assured by characterization and design.



## Typical Performance Curves

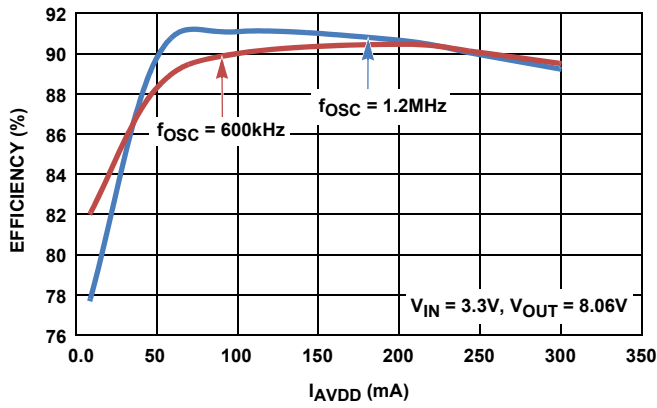

FIGURE 1. AVDD EFFICIENCY vs  $I_{AVDD}$

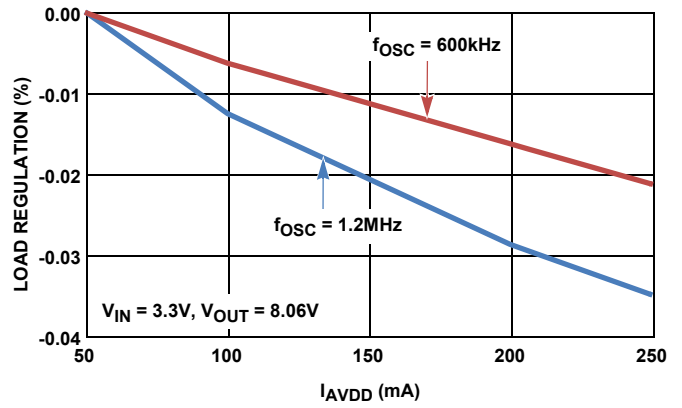

FIGURE 2. AVDD LOAD REGULATION vs  $I_{AVDD}$

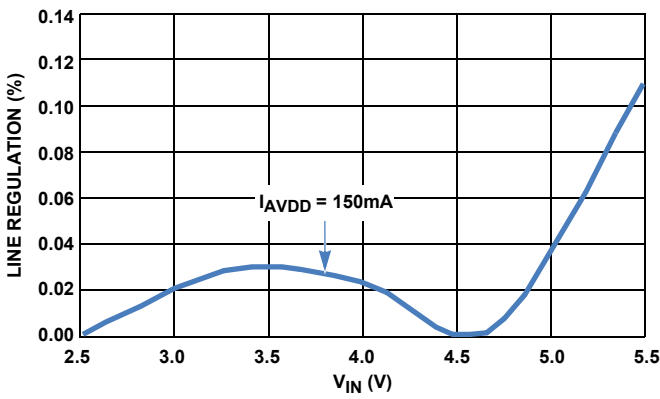

FIGURE 3. AVDD LINE REGULATION vs  $V_{IN}$

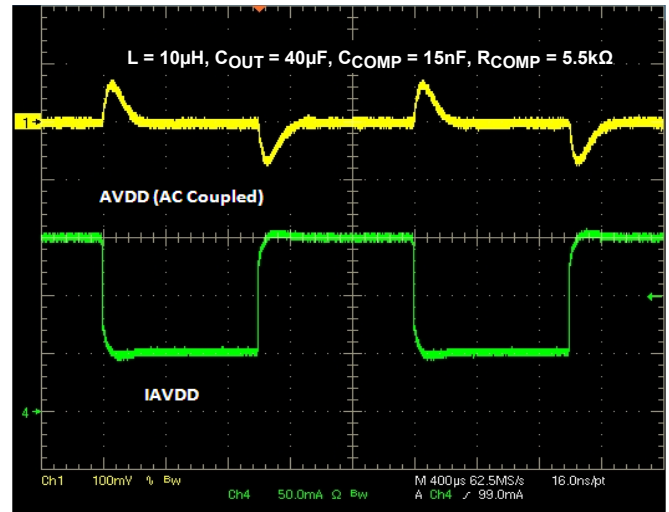

FIGURE 4. BOOST CONVERTER TRANSIENT RESPONSE

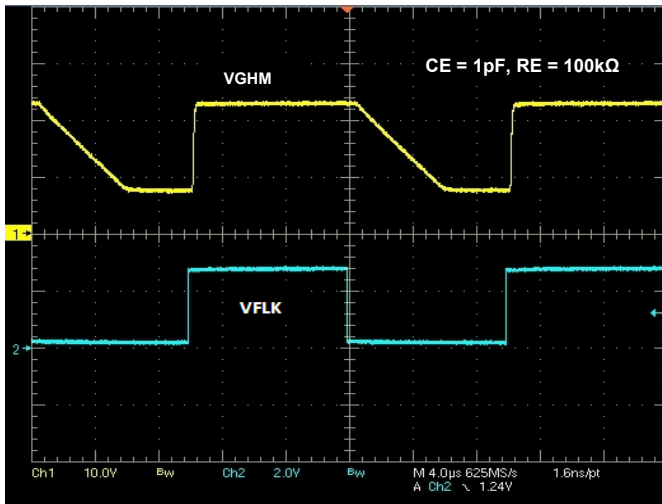

FIGURE 5. GPM CIRCUIT WAVEFORM

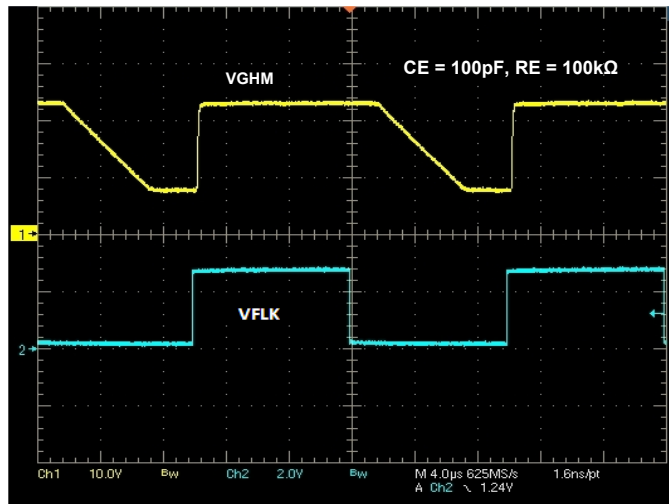

FIGURE 6. GPM CIRCUIT WAVEFORM

## Typical Performance Curves (Continued)

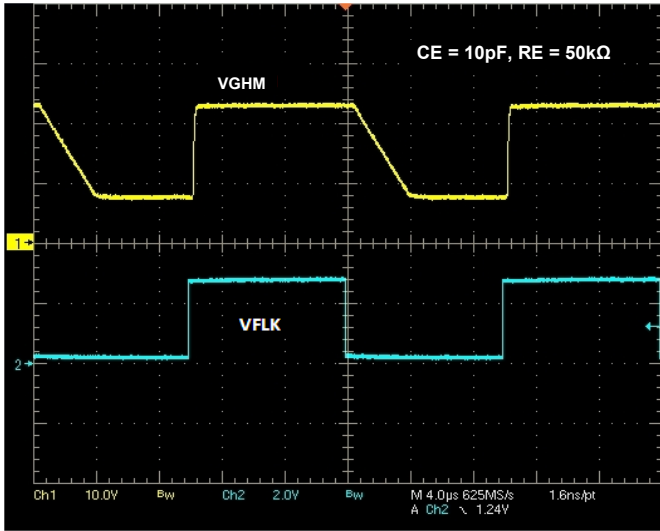

FIGURE 7. GPM CIRCUIT WAVEFORM

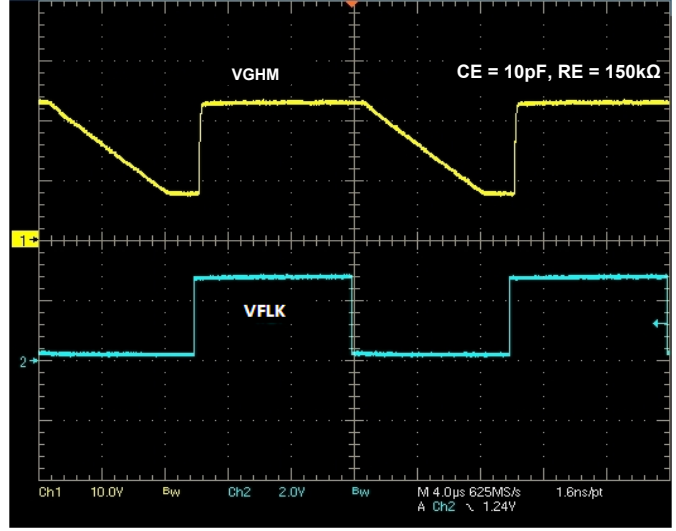

FIGURE 8. GPM CIRCUIT WAVEFORM

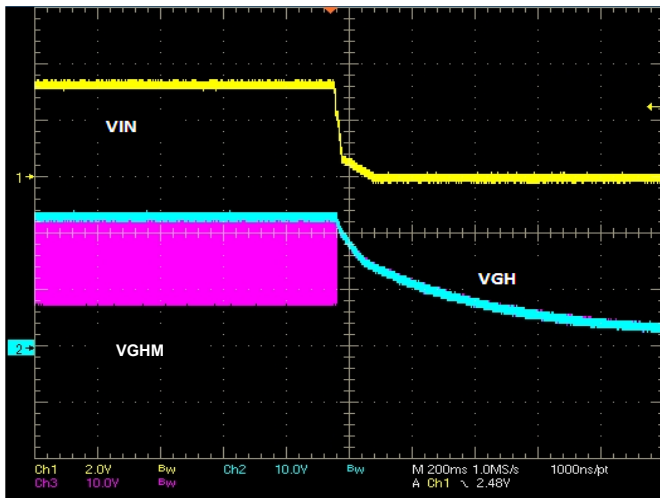

FIGURE 9.  $V_{GHM}$  FOLLOWS  $V_{GH}$  WHEN THE SYSTEM POWERS OFF

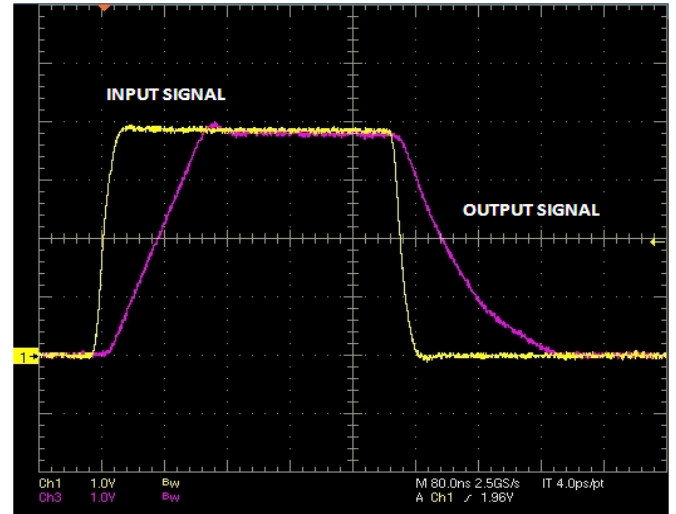

FIGURE 10. VCOM RISING SLEW RATE

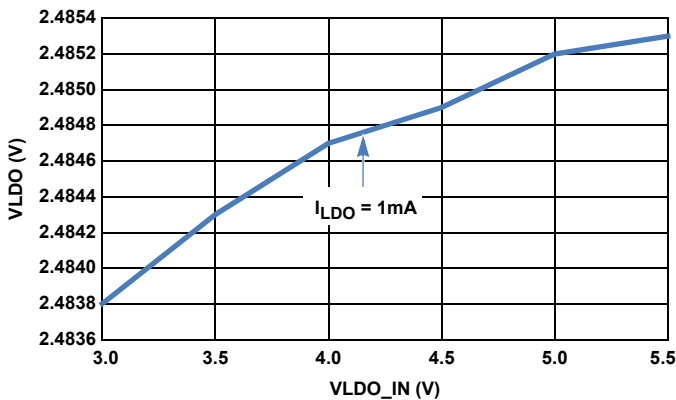

FIGURE 11. LDO LINE REGULATION vs  $V_{IN}$

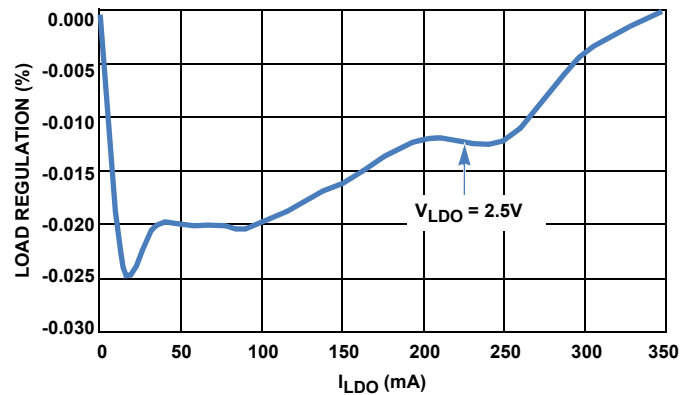

FIGURE 12. LDO LOAD REGULATION vs  $I_{LDO}$

## Applications Information

### Enable Control

With  $V_{IN} > UVLO$ , only the Logic output channel is activated. All other functions in ISL78419 are shut down when the enable pin is pulled down. When the voltage at the enable pin reaches high threshold, the whole chip turns on.

### Frequency Selection

The ISL78419 switching frequency can be user selected to operate at either constant 600kHz or 1.2MHz. Lower switching frequency can save power dissipation at very light load conditions. Also, low switching frequency more easily leads to discontinuous conduction mode, while higher switching frequency allows for smaller external components, such as inductor and output capacitors, etc. Higher switching frequency will get higher efficiency within some loading ranges depending on  $V_{IN}$ ,  $V_{OUT}$ , and external components, as shown in Figure 1. Connecting the  $FREQ$  pin to GND sets the PWM switching frequency to 600kHz, or connecting  $FREQ$  pin to  $V_{IN}$  for 1.2MHz.

### Soft-Start

The soft-start is provided by an internal current source to charge the external soft-start capacitor. The ISL78419 ramps up the current limit from 0A up to the full value, as the voltage at the  $SS$  pin ramps from 0V to 0.8V. Hence, the soft-start time is 3.2ms when the soft-start capacitor is 22nF, 6.8ms for 47nF and 14.5ms for 100nF.

### Operation

The boost converter is a current mode PWM converter operating at either 600kHz or 1.2MHz. It can operate in both discontinuous conduction mode (DCM) at light load and continuous conduction mode (CCM). In continuous conduction mode, current flows continuously in the inductor during the entire switching cycle in steady state operation. The voltage conversion ratio in continuous current mode is given by Equation 1:

$$\frac{V_{Boost}}{V_{IN}} = \frac{1}{1-D} \quad (EQ. 1)$$

Where  $D$  is the duty cycle of the switching MOSFET.

The boost regulator uses a summing amplifier architecture consisting of gm stages for voltage feedback, current feedback and slope compensation. A comparator looks at the peak inductor current cycle-by-cycle and terminates the PWM cycle if the current limit is reached.

An external resistor divider is required to divide the output voltage down to the nominal reference voltage. Current drawn by the resistor network should be limited to maintain the overall converter efficiency. The maximum value of the resistor network is limited by the feedback input bias current and the potential for noise being coupled into the feedback pin. A resistor network in the order of 60kΩ is recommended. The boost converter output voltage is determined by Equation 2:

$$V_{Boost} = \frac{R_1 + R_2}{R_2} \times V_{FB} \quad (EQ. 2)$$

The current through the MOSFET is limited to 1.5A<sub>PEAK</sub>.

This restricts the maximum output current (average) based on Equation 3:

$$I_{OMAX} = \left( I_{LMT} - \frac{\Delta I_L}{2} \right) \times \frac{V_{IN}}{V_O} \quad (EQ. 3)$$

Where  $\Delta I_L$  is the peak-to-peak inductor ripple current, and is set by Equation 4:

$$\Delta I_L = \frac{V_{IN}}{L} \times \frac{D}{f_s} \quad (EQ. 4)$$

Where  $f_s$  is the switching frequency (600kHz or 1.2MHz).

### Capacitor

An input capacitor is used to suppress the voltage ripple injected into the boost converter. The ceramic capacitor with a capacitance larger than 10μF is recommended. The voltage rating of the input capacitor should be larger than the maximum input voltage. Some input capacitors are recommended in Table 1.

TABLE 1. BOOST CONVERTER INPUT CAPACITOR RECOMMENDATION

CAPACITOR	SIZE	MFG	PART NUMBER
10μF/6.3V	0603	TDK	C1608X5R0J106M
10μF/16V	1206	TDK	C3216X7R1C106M
10μF/10V	0805	Murata	GRM21BR61A106K
22μF/10V	1210	Murata	GRB32ER61A226K

### Inductor

The boost inductor is a critical part that influences the output voltage ripple, transient response, and efficiency. Values of 3.3μH to 10μH are used to match the internal slope compensation. The inductor must be able to handle the following average and peak currents shown in Equation 5:

$$I_{LAVG} = \frac{I_O}{1-D} \quad (EQ. 5)$$

$$I_{LPK} = I_{LAVG} + \frac{\Delta I_L}{2}$$

Some inductors are recommended in Table 2 for different design considerations.

### Rectifier Diode

A high-speed diode is necessary due to the high switching frequency. Schottky diodes are recommended because of their fast recovery time and low forward voltage. The reverse voltage rating of this diode should be higher than the maximum output voltage. The rectifier diode must meet the output current and peak inductor current requirements. Table 3 shows some recommendations for boost converter diode.

TABLE 2. BOOST CONVERTER INDUCTOR RECOMMENDATION

INDUCTOR	DIMENSIONS (mm)	MFG	PART NUMBER	NOTE
10μH/ 4A <sub>peak</sub>	8.3x8.3x4.5	Sumida	CDR8D43-100NC	Efficiency optimization
6.8μH/ 1.8A <sub>peak</sub>	5.0x5.0x2.0	TDK	PLF5020T-6R8M1R8	
10μH/ 2.2A <sub>peak</sub>	6.6x7.3x1.2	Cyntec	PCME061B-100MS	PCB space/profile optimization

**TABLE 3. BOOST CONVERTER RECTIFIER DIODE RECOMMENDATION**

DIODE	V <sub>R</sub> /I <sub>AVG</sub> RATING	PACKAGE	MFG
PMEG2010ER	20V/1A	SOD123W	NXP
MSS1P2U	20V/1A	MicroSMP	VISHAY

## Output Capacitor

The output capacitor supplies the load directly and reduces the ripple voltage at the output. Output ripple voltage consists of two components:

1. The voltage drop due to the inductor ripple current flowing through the ESR of the output capacitor.
2. Charging and discharging of the output capacitor.

$$V_{\text{RIPPLE}} = I_{\text{LPK}} \times \text{ESR} + \frac{V_{\text{O}} - V_{\text{IN}}}{V_{\text{O}}} \times \frac{I_{\text{O}}}{C_{\text{OUT}}} \times \frac{1}{f_{\text{s}}} \quad (\text{EQ. 6})$$

For low ESR ceramic capacitors, the output ripple is dominated by the charging and discharging of the output capacitor. The voltage rating of the output capacitor should be greater than the maximum output voltage.

Note: Capacitors have a voltage coefficient that makes their effective capacitance drop as the voltage across them increases. C<sub>OUT</sub> in Equation 6 assumes the effective value of the capacitor at a particular voltage and not the manufacturer's stated value, measured at 0V.

Table 4 shows some selections of output capacitors.

**TABLE 4. BOOST OUTPUT CAPACITOR RECOMMENDATION**

CAPACITOR	SIZE	MFG	PART NUMBER
10μF/25V	1210	TDK	C3225X7R1E106M
10μF/25V	1210	Murata	GRM32DR61E106K

## Compensation

The boost converter of ISL78419 can be compensated by an RC network connected from the COMP pin to ground. A 15nF and 5.5kΩ RC network is used in the evaluation. The larger value resistor and lower value capacitor can lower the transient overshoot, however, at the expense of the stability of the loop.

## Linear Regulator (LDO)

The ISL78419 includes an LDO with adjustable output. It can supply current up to 350mA. The output voltage is adjusted by connection of the ADJ pin.

The efficiency of the LDO depends on the difference between input voltage and output voltage (Equation 7) by assuming LDO quiescent current is much lower than LDO output current:

$$\eta(\%) = \left( \frac{V_{\text{LDO\_IN}}}{V_{\text{LDO\_OUT}}} \right) \times 100\% \quad (\text{EQ. 7})$$

The less difference between input and output voltage, the higher efficiency it is.

Ceramic capacitors are recommended for the LDO input and output capacitors. Intersil recommends an output capacitor within the 1μF to 4.7μF range and a maximum feedback resistor impedance of 20kΩ. Larger capacitors help to reduce noise and deviation during transient load change. Some capacitors are recommended in Table 5.

**TABLE 5. LDO OUTPUT CAPACITOR RECOMMENDATION**

CAPACITOR	SIZE	MFG	PART NUMBER
1μF/10V	0603	TDK	C1608X7R1A105K
1μF/6.3V	0603	MURATA	GRM188R70J105K
2.2μF/6.3V	0603	TDK	C1608X7R0J225K

## Supply Monitor Circuit

The Supply Monitor circuit monitors the voltage on VDIV, and sets open-drain output RESET low when VDIV is below 1.28V (rising) or 1.22V (falling).

There is a delay on the rising edge, controlled by a capacitor on CD2. When VDIV exceeds 1.28V (rising), CD2 is charged up from 0V to 1.217V by a 10μA current source. Once CD2 exceeds 1.217V, RESET will go tri-state. When VDIV falls below 1.22V, RESET will become low with a 650Ω pull-down resistance. The delay time is controlled by Equation 8:

$$t_{\text{delay}} = 121.7\text{k} \times \text{CD2} \quad (\text{EQ. 8})$$

For example, the delay time is 12.17ms if the CD2 = 100nF.

Figure 13 shows the Supply Monitor Circuit timing diagram.

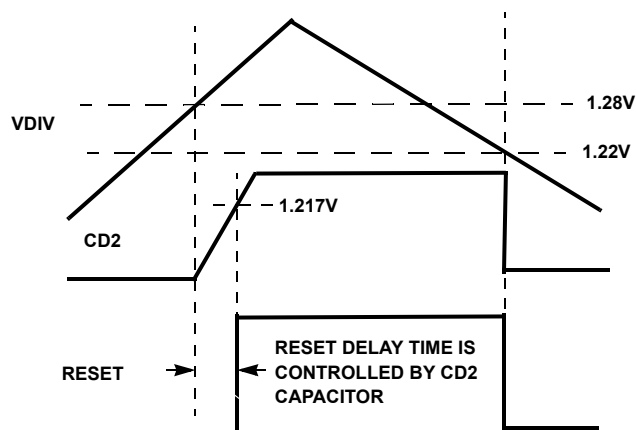

**FIGURE 13. SUPPLY MONITOR CIRCUIT TIMING DIAGRAM**

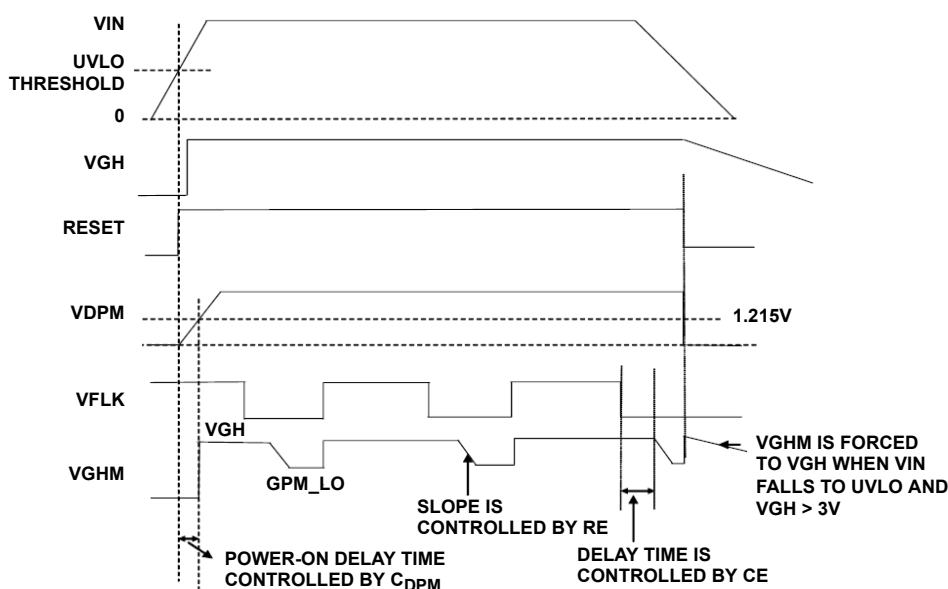

FIGURE 14. GATE PULSE MODULATOR TIMING DIAGRAM

## Gate Pulse Modulator Circuit

The gate pulse modulator circuit functions as a three way multiplexer, switching VGHM between ground, GPM\_LO and VGH. Voltage selection is provided by digital inputs VDPM (enable) and VFLK (control). High to low delay and slew control is provided by external components on pins CE and RE, respectively.

When VDPM is LOW, the block is disabled and VGHM is grounded. When the input voltage exceeds UVLO threshold, VDPM starts to drive an external capacitor. Once VDPM exceeds 1.215V, the GPM circuit is enabled, and the output VGHM is determined by VFLK, RESET signal and VGH voltage. If the RESET signal is high and VFLK is high, VGHM is pulled to VGH. When VFLK goes low, there is a delay controlled by capacitor CE, following which, VGHM is driven to GPM\_LO, with a slew rate controlled by resistor RE. Note that GPM\_LO is used only as a reference voltage for an amplifier, and thus does not have to source or sink a significant DC current.

Low to high transition is determined primarily by the switch resistance and the external capacitive load. High to low transition is more complex. Take the case where the block is already enabled (VDPM is high). When VFLK is high, if CE is not externally pulled above threshold voltage 1, pin CE is pulled low. On the falling edge of VFLK, a current is passed into pin CE to charge the external capacitor up to threshold voltage 2, providing a delay which is adjustable by varying the capacitor on CE. Once this threshold is reached, the output starts to be pulled down from VGH to GPM\_LO. The maximum slew current is equal to  $500/(RE + 40k)$ , and the  $dv/dt$  slew rate is  $Is/C_{LOAD}$ , where  $C_{LOAD}$  is the load capacitance applied to VGHM. The slew rate reduces as VGHM approaches GPM\_LO.

If CE is always pulled up to a voltage above threshold 1, zero delay mode is selected; thus there will be no delay from FLK falling to the point where VGHM starts to fall. Slew down currents will be identical to the previous case.

At power-down, when VIN falls to UVLO, VGHM will be tied to VGH until the VGH voltage falls to 3V. Once the VGH voltage falls below 3V, VGHM will not be actively driven until VIN is driven. Figure 14 shows the VGHM voltage based on  $V_{IN}$ , VGH and RESET.

## VCOM Amplifier

The VCOM amplifier is designed to control the voltage on the back plane of an LCD display. This plane is capacitively coupled to the pixel drive voltage, which alternately cycles positive and negative at the line rate for the display. Thus, the amplifier must be capable of sourcing and sinking pulses of current, which can occasionally be quite large (in the range of 100mA for typical applications).

The ISL78419 VCOM amplifier's output current is limited to 225mA typical. This limit level, which is roughly the same for sourcing and sinking, is included to maintain reliable operation of the part. It does not necessarily prevent a large temperature rise if the current is maintained. (In this case, the whole chip may be shut down by the thermal trip to protect functionality.) If the display occasionally demands current pulses higher than this limit, the reservoir capacitor will provide the excess and the amplifier will top the reservoir capacitor back up once the pulse has stopped. This will happen in the  $\mu s$  time scale in practical systems and for pulses 2 or 3 times the current limit; the VCOM voltage will have settled again before the next line is processed.

## DCP Memory Description

The ISL78419 contains 1 non-volatile byte known as the Initial Value Register (IVR). It is accessed by the  $I^2C$  interface operations with Address 00h. The IVR contains the value that is loaded into the Volatile Wiper Register (WR) at power-up.

The volatile WR, and the non-volatile IVR of a DCP are accessed with the same address.

The Access Control Register (ACR) determines which word at address 00h is accessed (IVR or WR). The volatile ACR must be set as follows:

- When the ACR is all zeroes, which is the default at power-up:
  - A read operation to address 0 outputs the value of the non-volatile IVR
  - A write operation to address 0 writes the identical values to the WR and IVR of the DCP
- When the ACR is 80h:
  - A read operation to address 0 outputs the value of the volatile WR
  - A write operation to address 0 only writes to the volatile WR

It is not possible to write to an IVR without writing the same value to its WR.

00h and 80h are the only values that should be written to address 2. All other values are reserved and must not be written to address 2.

**TABLE 6. MEMORY MAP**

ADDRESS	NON-VOLATILE	VOLATILE
2	-	ACR
1	Reserved	
0	IVR	WR

WR: Wiper Register, IVR: Initial value Register.

## I<sup>2</sup>C Serial Interface

The ISL78419 supports a bidirectional bus oriented protocol. The protocol defines any device that sends data on to the bus as a transmitter and the receiving device as the receiver. The device controlling the transfer is a master and the device being controlled is the slave. The master always initiates data transfers and provides the clock for both transmit and receive operations. Therefore, the DCP of the ISL78419 operates as a slave device in all applications. The fall and rise time of SDA and SCL signal should be in the range listed in Table 8. Capacitive load on I<sup>2</sup>C bus is also specified in Table 8.

All communication over the I<sup>2</sup>C interface is conducted by sending the MSB of each byte of data first.

## Protocol Conventions

Data states on the SDA line can change only during SCL LOW periods. SDA state changes during SCL HIGH are reserved for indicating START and STOP conditions (see Figure 15). On power-up of the ISL78419, the SDA pin is in the input mode.

All I<sup>2</sup>C interface operations must begin with a START condition, which is a HIGH to LOW transition of SDA while SCL is HIGH. The DCP continuously monitors the SDA and SCL lines for the START condition and does not respond to any command until this condition is met (see Figure 15). A START condition is ignored during the power-up sequence and during internal non-volatile write cycles.

All I<sup>2</sup>C interface must be terminated by a STOP condition, which is a LOW to HIGH transition of SDA while SCL is high (see Figure 15). A STOP condition at the end of a read operation, or at the end of a write operation to volatile bytes only places the device in its standby mode. A STOP condition during a write operation to a non-volatile write byte, initiates an internal non-volatile write cycle. The device enters its standby state when the internal non-volatile write cycle is completed.

An ACK (Acknowledge) is a software convention used to indicate a successful data transfer. The transmitting device, either master or slave, releases the SDA bus after transmitting eight bits. During the ninth clock cycle, the receiver pulls the SDA line LOW to acknowledge the reception of the eight bits of data (see Figure 16).

The ISL78419 DCP responds with an ACK after recognition of a START condition followed by a valid Identification Byte, and once again after successful receipt of an Address Byte. The ISL78419 also responds with an ACK after receiving a Data Byte of a write operation. The master must respond with an ACK after receiving a Data Byte of a read operation.

A valid Identification Byte contains 0101000 as the seven MSBs. The LSB is in the Read/Write bit. Its value is "1" for a Read operation, and "0" for a Write operation (see Table 7).

**TABLE 7. IDENTIFICATION BYTE FORMAT**

0	1	0	1	0	0	0	R/ $\bar{W}$
(MSB)							(LSB)

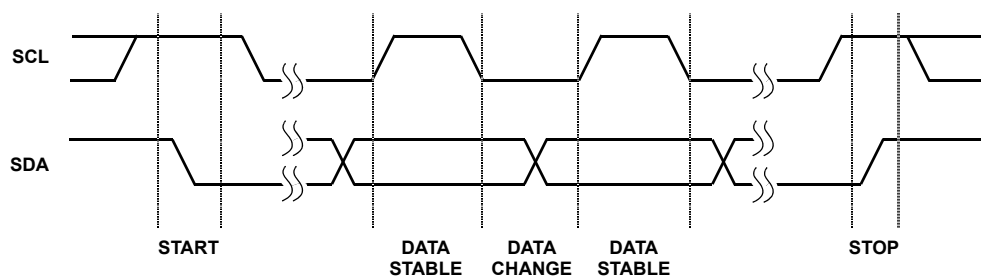

**FIGURE 15. VALID DATA CHANGES, START, AND STOP CONDITIONS**



# ISL78419

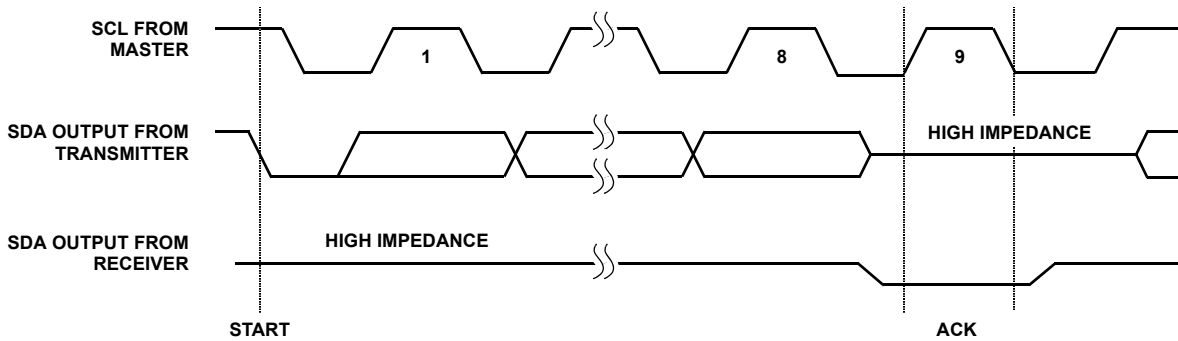

FIGURE 16. ACKNOWLEDGE RESPONSE FROM RECEIVER

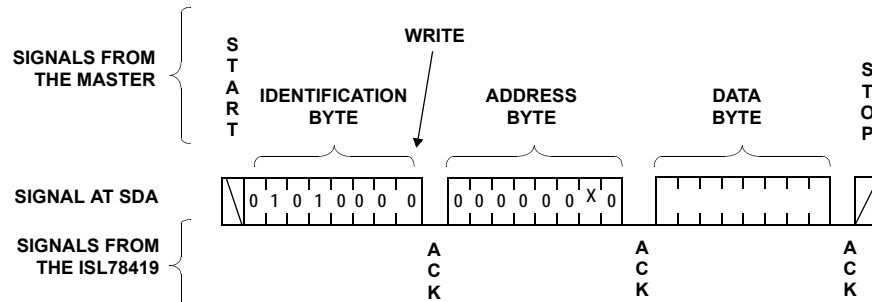

FIGURE 17. BYTE WRITE SEQUENCE

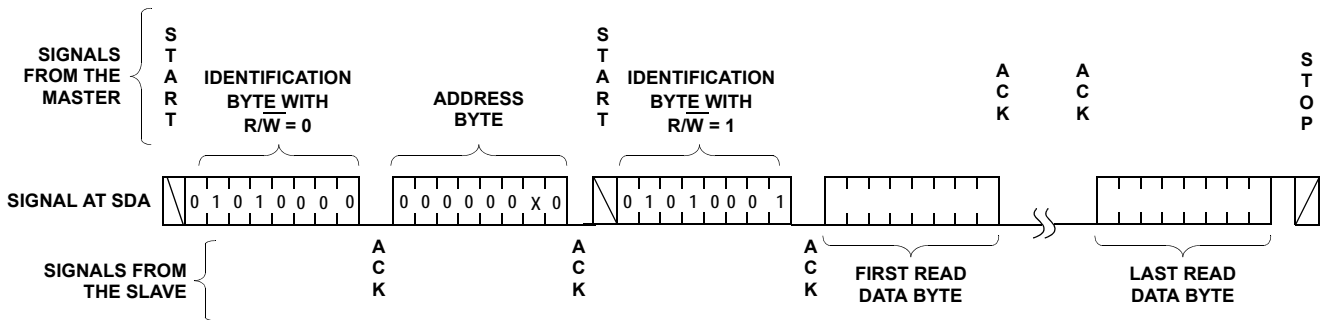

FIGURE 18. READ SEQUENCE

## Write Operation

A write operation requires a START condition, followed by a valid Identification Byte, a valid Address Byte, a Data Byte, and a STOP condition (see Figure 17). After each of the three bytes, the ISL78419 responds with an ACK. At this time, if the Data Byte is to be written only to volatile registers, the device enters its standby state. If the Data Byte is to be written also to non-volatile memory, the ISL78419 begins its internal write cycle to non-volatile memory. During the internal non-volatile write cycle, the device ignores transitions at the SDA and SCL pins and the SDA output is at high impedance state. When the internal non-volatile write cycle is completed, the ISL78419 enters its standby state. The byte at address 02h determines if the Data Byte is to be written to volatile and/or non-volatile memory.

## Data Protection

A STOP condition also acts as a protection of non-volatile memory. A valid Identification Byte, Address Byte, and total number of SCL pulses act as a protection of both volatile and non-volatile registers. During a Write sequence, the Data Byte is loaded into an internal shift register as it is received. If the Address Byte is 0 or 2, the Data Byte is transferred to the Wiper Register (WR) or to the Access Control Register respectively, at the falling edge of the SCL pulse that loads the last bit (LSB) of the Data Byte. If the Address Byte is 0, and the Access Control Register is all zeros (default), then the STOP condition initiates the internal write cycle to non-volatile memory.

TABLE 8. I<sup>2</sup>C INTERFACE SPECIFICATION

PARAMETER	MIN	TYP	MAX	UNITS
SDA and SCL Rise Time			1000	ns
SDA and SCL Fall Time			300	ns
I <sup>2</sup> C Bus Capacitive Load			400	pF

## Read Operation

A read operation consists of a three byte instruction followed by one or more Data Bytes (see Figure 18). The master initiates the operation issuing the following sequence: a START, the Identification byte with the R/W bit set to "0", an Address Byte, a second START, and a second Identification byte with the R/W bit set to "1". After each of the three bytes, the ISL78419 responds with an ACK; then the ISL78419 transmits the Data Byte. The master then terminates the read operation (issuing a STOP condition) following the last bit of the Data Byte (see Figure 16).

The byte at address 02h determines if the Data Bytes being read are from volatile or non-volatile memory.

## Communication with ISL78419

There are 3 register addresses in the ISL78419, of which two can be used. Address 00h and address 02h are used to control the device. Address 01h is reserved and should not be used. Address 00h contains the non-volatile Initial Value Register (IVR), and the volatile Wiper Register (WR). Address 02h contains only a volatile word and is used as a pointer to either the IVR or WR.

## Register Description: Access Control

The Access Control Register (ACR) is volatile and is at address 02h. It is 8 bits, and only the MSB is significant; all other bits

should be zero (0). The ACR controls which word is accessed at register 00h as follows:

- 00h = Nonvolatile IVR
- 80h = Volatile WR

All other bits of the ACR should be written 0 or 1. Power-up default for this address is 00h.

## Register Description: IVR and WR

The output of the DCP is controlled directly by the WR. Writes and reads can be made directly to this register to control and monitor without any non-volatile memory changes. This is done by setting address 02h to data 80h, then writing the data.

The non-volatile IVR stores the power-up value of the DCP output. On power-up, the contents of the IVR are transferred to the WR.

To write to the IVR, first address 02h is set to data 00h, then the data is written. Writing a new value to the IVR register will set a new power-up position for the wiper. Also, writing to this register will load the same value into the WR as the IVR. Therefore, if a new value is loaded into the IVR, not only will the non-volatile IVR change, but the WR will also contain the same value after the write, and the wiper position will change. Reading from the IVR will not change the WR, if its contents are different.

Writing a new value to the IVR

Write to ACR first

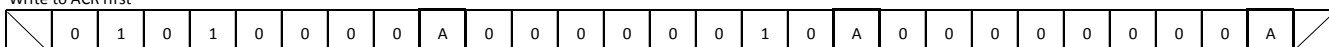

Then, write to IVR

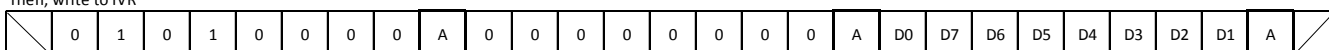

Note that the WR will also reflect this new value since both registers get written at the same time

D0:LSB, D7:MSB

Writing a new value to WR only

Write to ACR first

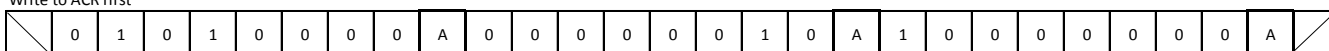

Then, write to WR

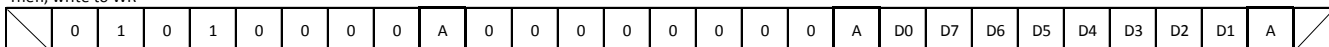

Note that the IVR value will NOT change

D0:LSB, D7:MSB

Reading from IVR

Write to the ACR first

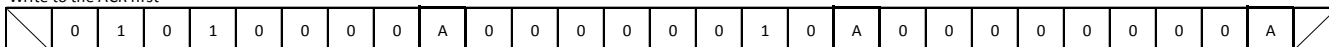

Then set the IVR address

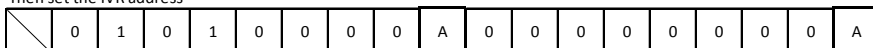

Read from the IVR

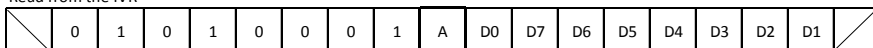

Example 2

Reading from the WR

Write to the ACR first

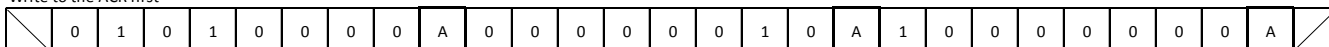

Then set the WR address

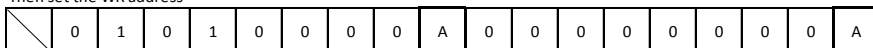

Read from the WR

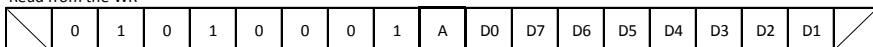

FIGURE 19.



## Initial VCOM Setting

A 256-step resolution is provided under digital control, which adjusts the sink current of the output. The output is connected to an external voltage divider, so that the device will have the capability to reduce the voltage on the output by increasing the output sink current. The equations that control the output are given in the following. The initial setting value is at 128. The WR value is set back to 128 if any error occurs during I<sup>2</sup>C read or write communication. When writing to the EEPROM, VGH needs to be higher than 12V when AVDD is 8V. Outside these conditions, writing operations may be not successful. The maximum resistor value of RSET is determined by Equations 9 and 10:

$$RSET > V_{AVDD} / (20 \times 100 \mu A) \quad (\text{EQ. 9})$$

$$I_{OUT} = \frac{255 - \text{Setting}}{255} \cdot \frac{V_{AVDD}}{20(RSET)} \quad (\text{EQ. 10})$$

Where R<sub>L</sub>, R<sub>U</sub> and RSET in Equation 11 correspond to R<sub>7</sub>, R<sub>8</sub> and R<sub>9</sub> in the Application Diagram on page 2.

$$V_{OUT} = \frac{R_L \cdot V_{AVDD}}{(R_U + R_L)} \cdot \left( 1 - \frac{255 - \text{Setting}}{255} \times \frac{R_U}{20(RSET)} \right) \quad (\text{EQ. 11})$$

## Start-up Sequence

When VIN rising exceeds UVLO, it takes 120μs to read the settings stored in the chip in order to activate the chip correctly. After all the settings are written in the registers, VLOGIC starts up with a 0.5ms soft-start time. When both VLOGIC is in regulation and EN is high, the boost converter starts up. The Gate Pulse modulator output VGHM is held low until VDPM is charged to 1.215V. The detailed power-on sequence is shown in Figure 20.

## Layout Recommendation

The device's performance, including efficiency, output noise, transient response and control loop stability, is affected by the PCB layout. PCB layout is critical, especially at high switching frequency.

Following are some general guidelines for layout:

1. Place the external power components (the input capacitors, output capacitors, boost inductor and output diodes, etc.) in close proximity to the device. Traces to these components should be kept as short and wide as possible to minimize parasitic inductance and resistance.
2. Place V<sub>DC</sub> and V<sub>REF</sub> bypass capacitors close to the pins.
3. Loops with large AC amplitudes and fast slew rate should be made as small as possible.
4. The feedback network should sense the output voltage directly from the point of load, and be as far away from the LX node as possible.
5. The power ground (PGND) should be connected at the ISL78419 exposed die plate area.
6. The exposed die plate, on the underside of the package, should be soldered to an equivalent area of metal on the PCB. This contact area should have multiple via connections to the back of the PCB, as well as connections to intermediate PCB layers, if available, to maximize thermal dissipation away from the IC.
7. To minimize the thermal resistance of the package when soldered to a multi-layer PCB, the amount of copper track and ground plane area connected to the exposed die plate should be maximized and spread out as far as possible from the IC. The bottom and top PCB areas especially should be maximized to allow thermal dissipation to the surrounding air.
8. Minimize feedback input track lengths to avoid switching noise pick-up.

# ISL78419

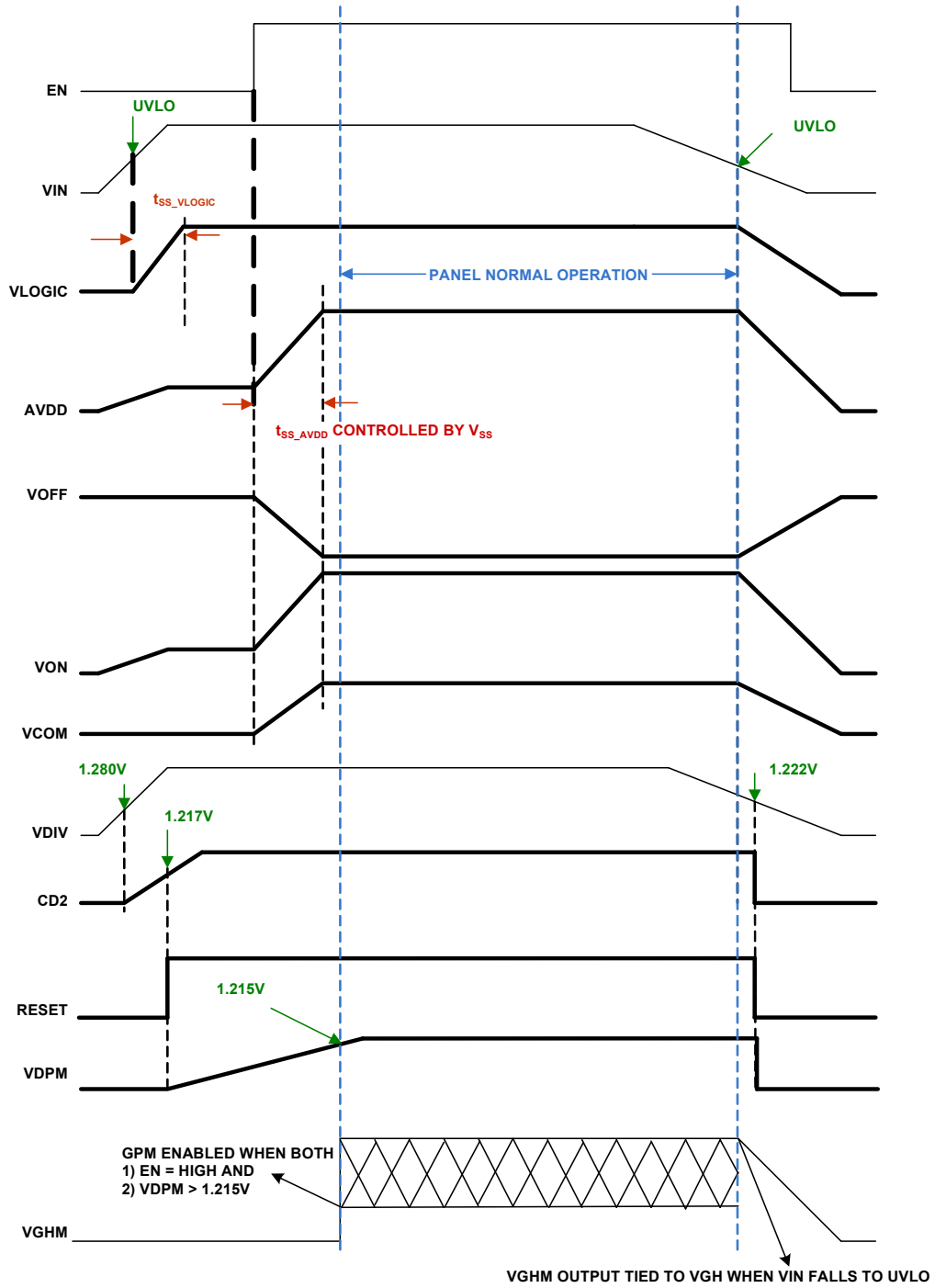

FIGURE 20. ISL78419 POWER ON/OFF SEQUENCE

## Revision History

The revision history provided is for informational purposes only and is believed to be accurate, but not warranted. Please go to web to make sure you have the latest revision.

DATE	REVISION	CHANGE
December 3, 2012	FN8292.1	Initial Release.

## About Intersil

Intersil Corporation is a leader in the design and manufacture of high-performance analog, mixed-signal and power management semiconductors. The company's products address some of the fastest growing markets within the industrial and infrastructure, personal computing and high-end consumer markets. For more information about Intersil or to find out how to become a member of our winning team, visit our website and career page at [www.intersil.com](http://www.intersil.com).

For a complete listing of Applications, Related Documentation and Related Parts, please see the respective product information page. Also, please check the product information page to ensure that you have the most updated datasheet: [ISL78419](#)

To report errors or suggestions for this datasheet, please go to: [www.intersil.com/askourstaff](http://www.intersil.com/askourstaff)

Reliability reports are available from our website at: <http://rel.intersil.com/reports/search.php>

For additional products, see [www.intersil.com/product\\_tree](http://www.intersil.com/product_tree)

Intersil products are manufactured, assembled and tested utilizing ISO9000 quality systems as noted in the quality certifications found at [www.intersil.com/design/quality](http://www.intersil.com/design/quality)

*Intersil products are sold by description only. Intersil Corporation reserves the right to make changes in circuit design, software and/or specifications at any time without notice. Accordingly, the reader is cautioned to verify that data sheets are current before placing orders. Information furnished by Intersil is believed to be accurate and reliable. However, no responsibility is assumed by Intersil or its subsidiaries for its use; nor for any infringements of patents or other rights of third parties which may result from its use. No license is granted by implication or otherwise under any patent or patent rights of Intersil or its subsidiaries.*

For information regarding Intersil Corporation and its products, see [www.intersil.com](http://www.intersil.com)

## Package Outline Drawing

### L28.4x5A

28 LEAD QUAD FLAT NO-LEAD PLASTIC PACKAGE

Rev 2, 06/08

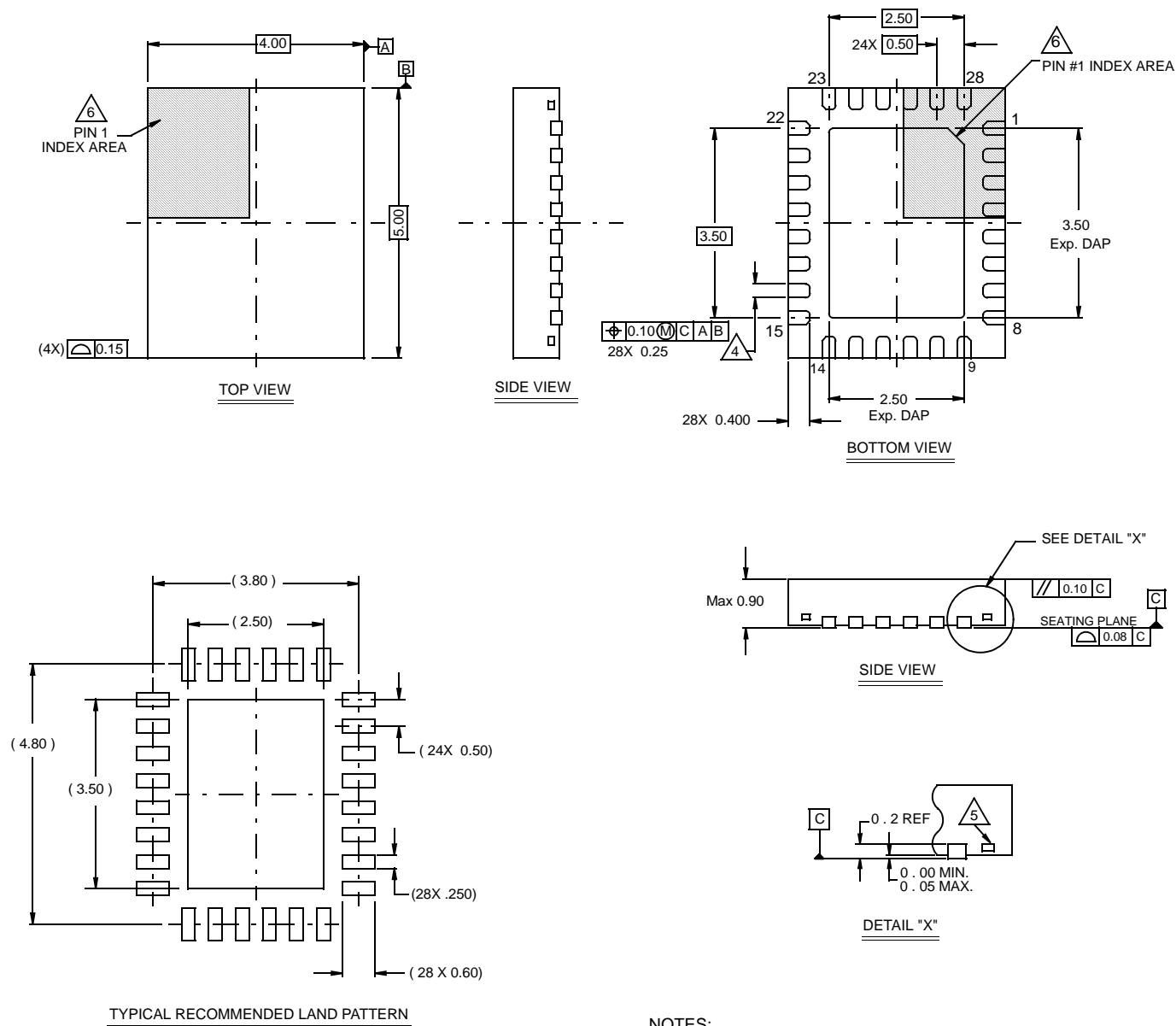

#### NOTES:

1. Dimensions are in millimeters.  
Dimensions in ( ) for Reference Only.
2. Dimensioning and tolerancing conform to AMSE Y14.5m-1994.
3. Unless otherwise specified, tolerance : Decimal  $\pm 0.05$
4. Dimension b applies to the metallized terminal and is measured between 0.15mm and 0.30mm from the terminal tip.
5. Tiebar shown (if present) is a non-functional feature.
6. The configuration of the pin #1 identifier is optional, but must be located within the zone indicated. The pin #1 identifier may be either a mold or mark feature.