

# FAN7388

## 3 Half-Bridge Gate-Drive IC

### Features

- Floating Channel for Bootstrap Operation to +600 V
- Typically 350 mA / 650 mA Sourcing / Sinking Current Driving Capability for All Channels
- 3 Half-Bridge Gate Driver
- Extended Allowable Negative  $V_S$  Swing to -9.8 V for Signal Propagation at  $V_{BS}=15$  V
- Matched Propagation Delay Time Maximum 50 ns
- 3.3 V and 5 V Input Logic Compatible
- Built-in Shoot-Through Prevention Circuit for All Channels with Typically 270 ns Dead Time
- Built-in Common Mode  $dv/dt$  Noise Canceling Circuit
- Built-in UVLO Functions for All Channels

### Applications

- 3-Phase Motor Inverter Driver

### Description

The FAN7388 is a monolithic three half-bridge gate-drive IC designed for high-voltage, high-speed, driving MOS-FETs and IGBTs operating up to +600 V.

Fairchild's high-voltage process and common-mode noise canceling technique provide stable operation of high-side drivers under high- $dv/dt$  noise circumstances.

An advanced level-shift circuit allows high-side gate driver operation up to  $V_S = -9.8$  V (typical) for  $V_{BS} = 15$  V.

The UVLO circuits prevent malfunction when  $V_{DD}$  and  $V_{BS}$  are lower than the specified threshold voltage.

Output drivers typically source / sink 350 mA / 650 mA, respectively, which is suitable for three-phase half-bridge applications in motor drive systems.

20-SOIC



### Ordering Information

Part Number	Package	Operating Temperature Range	Packing Method
FAN7388MX	20-SOIC	-40°C to +125°C	Tape & Reel



## Pin Configuration

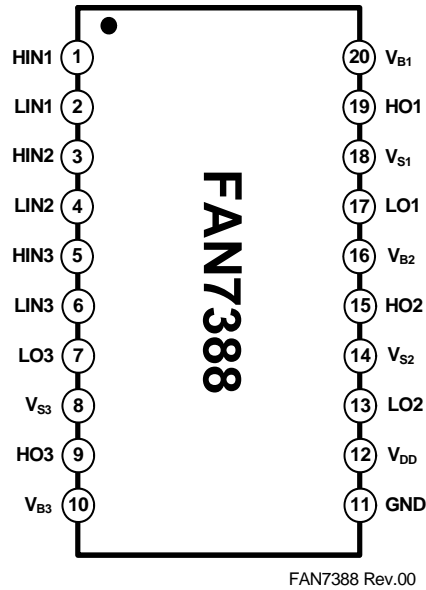

FAN7388 Rev.00

Figure 3. Pin Configuration (Top View)

## Pin Definitions

Pin #	Name	Description
1	HIN1	Logic input 1 for high-side gate 1 driver
2	LIN1	Logic input 1 for low-side gate 1 driver
3	HIN2	Logic input 2 for high-side gate 2 driver
4	LIN2	Logic input 2 for low-side gate 2 driver
5	HIN3	Logic input 3 for high-side gate 3 driver
6	LIN3	Logic input 3 for low-side gate 3 driver
7	LO3	Low-side gate driver 3 output
8	$V_{S3}$	High-side driver 3 floating supply offset voltage
9	HO3	High-side driver 3 gate driver output
10	$V_{B3}$	High-side driver 3 floating supply voltage
11	GND	Ground
12	$V_{DD}$	Logic and all low-side gate drivers power supply voltage
13	LO2	Low-side gate driver 2 output
14	$V_{S2}$	High-side driver 2 floating supply offset voltage
15	HO2	High-side driver 2 gate driver output
16	$V_{B2}$	High-side driver 2 floating supply voltage
17	LO1	Low-side gate driver 1 output
18	$V_{S1}$	High-side driver 1 floating supply offset voltage
19	HO1	High-side driver 1 gate driver output
20	$V_{B1}$	High-side driver 1 floating supply voltage

## Absolute Maximum Ratings

Stresses exceeding the absolute maximum ratings may damage the device. The device may not function or be operable above the recommended operating conditions and stressing the parts to these levels is not recommended. In addition, extended exposure to stresses above the recommended operating conditions may affect device reliability. The absolute maximum ratings are stress ratings only.  $T_A=25^{\circ}\text{C}$ , unless otherwise specified.

Symbol	Parameter	Min.	Max.	Unit
$V_B$	High-side Floating Supply Voltage of $V_{B1,2,3}$	-0.3	625.0	V
$V_S$	High-side Floating Supply Offset Voltage of $V_{S1,2,3}$	$V_{B1,2,3}-25$	$V_{B1,2,3}+0.3$	V
$V_{HO1,2,3}$	High-side Floating Output Voltage	$V_{S1,2,3}-0.3$	$V_{B1,2,3}+0.3$	V
$V_{DD}$	Low-side and Logic-fixed Supply Voltage	-0.3	25.0	V
$V_{LO1,2,3}$	Low-side Output Voltage	-0.3	$V_{DD}+0.3$	V
$V_{IN}$	Logic Input Voltage (HIN1,2,3 and LIN1,2,3)	-0.3	$V_{DD}+0.3$	V
$dV_S/dt$	Allowable Offset Voltage Slew Rate		50	V/ns
$P_D$	Power Dissipation <sup>(1,2,3)</sup>		1.47	W
$\theta_{JA}$	Thermal Resistance, Junction-to-ambient		85	$^{\circ}\text{C}/\text{W}$
$T_J$	Junction Temperature		+150	$^{\circ}\text{C}$
$T_S$	Storage Temperature	-55	+150	$^{\circ}\text{C}$

### Notes:

- Mounted on 76.2 x 114.3 x 1.6 mm PCB (FR-4 glass epoxy material).
- Refer to the following standards:
  - JESD51-2: Integral circuits thermal test method environmental conditions - natural convection
  - JESD51-3: Low effective thermal conductivity test board for leaded surface-mount packages.
- Do not exceed  $P_D$  under any circumstances.

## Recommended Operating Conditions

The Recommended Operating Conditions table defines the conditions for actual device operation. Recommended operating conditions are specified to ensure optimal performance to the datasheet specifications. Fairchild does not recommend exceeding them or designing to Absolute Maximum Ratings.

Symbol	Parameter	Min.	Max.	Unit
$V_{B1,2,3}$	High-side Floating Supply Voltage	$V_{S1,2,3}+10$	$V_{S1,2,3}+20$	V
$V_{S1,2,3}$	High-side Floating Supply Offset Voltage	$6-V_{DD}$	600	V
$V_{DD}$	Supply Voltage	10	20	V
$V_{HO1,2,3}$	High-Side Output Voltage	$V_{S1,2,3}$	$V_{B1,2,3}$	V
$V_{LO1,2,3}$	Low-Side Output Voltage	GND	$V_{DD}$	V
$V_{IN}$	Logic Input Voltage (HIN1,2,3 and LIN1,2,3)	GND	$V_{DD}$	V
$T_A$	Ambient Temperature	-40	+125	$^{\circ}\text{C}$

## Electrical Characteristics

$V_{BIAS}$  ( $V_{DD}$ ,  $V_{BS1,2,3}$ ) = 15.0 V,  $T_A$  = 25°C, unless otherwise specified. The  $V_{IN}$  and  $I_{IN}$  parameters are referenced to GND. The  $V_O$  and  $I_O$  parameters are referenced to GND and  $V_{S1,2,3}$  and are applicable to the respective outputs LO1,2,3 and HO1,2,3.

Symbol	Characteristics	Condition	Min.	Typ.	Max.	Unit
<b>LOW SIDE POWER SUPPLY SECTION</b>						
$I_{QDD}$	Quiescent $V_{DD}$ Supply Current	$V_{LIN1,2,3}=0$ V or 5 V		160	350	$\mu$ A
$I_{PDD1,2,3}$	Operating $V_{DD}$ Supply Current for each Channel	$f_{LIN1,2,3}=20$ kHz, rms Value		500	900	$\mu$ A
$V_{DDUV+}$	$V_{DD}$ Supply Under-Voltage Positive-Going Threshold	$V_{DD}=\text{Sweep}$ , $V_{BS}=15$ V	7.2	8.2	9.0	V
$V_{DDUV-}$	$V_{DD}$ Supply Under-Voltage Negative-Going Threshold	$V_{DD}=\text{Sweep}$ , $V_{BS}=15$ V	6.8	7.8	8.5	V
$V_{DDHYS}$	$V_{DD}$ Supply Under-Voltage Lockout Hysteresis	$V_{DD}=\text{Sweep}$ , $V_{BS}=15$ V		0.4		V
<b>BOOTSTRAPPED POWER SUPPLY SECTION</b>						
$I_{QBS1,2,3}$	Quiescent $V_{BS}$ Supply Current for each Channel	$V_{HIN1,2,3}=0$ V or 5 V		50	120	$\mu$ A
$I_{PBS1,2,3}$	Operating $V_{BS}$ Supply Current for each Channel	$f_{HIN1,2,3}=20$ kHz, rms Value		400	800	$\mu$ A
$V_{BSUV+}$	$V_{BS}$ Supply Under-Voltage Positive-Going Threshold	$V_{DD}=15$ V, $V_{BS}=\text{Sweep}$	7.2	8.2	9.0	V
$V_{BSUV-}$	$V_{BS}$ Supply Under-Voltage Negative-Going Threshold	$V_{DD}=15$ V, $V_{BS}=\text{Sweep}$	6.8	7.8	8.5	V
$V_{BSHYS}$	$V_{BS}$ Supply Under-Voltage Lockout Hysteresis	$V_{DD}=15$ V, $V_{BS}=\text{Sweep}$		0.4		V
$I_{LK}$	Offset Supply Leakage Current	$V_{B1,2,3}=V_{S1,2,3}=600$ V			10	$\mu$ A
<b>GATE DRIVER OUTPUT SECTION</b>						
$V_{OH}$	High-Level Output Voltage, $V_{BIAS}-V_O$	$I_O=20$ mA			1.0	V
$V_{OL}$	Low-Level Output Voltage, $V_O$	$I_O=20$ mA			0.6	V
$I_{O+}^{(4)}$	Output HIGH Short-Circuit Pulsed Current	$V_O=0$ V, $V_{IN}=5$ V with $PW<10\mu$ s	250	350		mA
$I_{O-}^{(4)}$	Output LOW Short-Circuit Pulsed Current	$V_O=15$ V, $V_{IN}=0$ V with $PW<10\mu$ s	500	650		mA
$V_S$	Allowable Negative $V_S$ Pin Voltage for IN Signal Propagation to $H_O$			-9.8	-7.0	V
<b>LOGIC INPUT SECTION (HIN, LIN)</b>						
$V_{IH}$	Logic "1" Input Voltage		2.5			V
$V_{IL}$	Logic "0" Input Voltage				1	V
$I_{IN+}$	Logic "1" Input Bias Current	$V_{IN}=5$ V		25	50	$\mu$ A
$I_{IN-}$	Logic "0" Input Bias Current <sup>(4)</sup>	$V_{IN}=0$ V			2	$\mu$ A
$R_{IN}$	Input Pull-Down Resistance		100	200	300	K $\Omega$

### Note:

4. This parameter is guaranteed by design.

## Dynamic Electrical Characteristics

$T_A=25^\circ\text{C}$ ,  $V_{\text{BIAS}} (V_{\text{DD}}, V_{\text{BS1,2,3}}) = 15.0\text{ V}$ ,  $V_{\text{S1,2,3}} = \text{GND}$ ,  $C_{\text{Load}} = 1000\text{ pF}$  unless otherwise specified.

Symbol	Parameter	Conditions	Min.	Typ.	Max.	Unit
$t_{\text{ON}}$	Turn-on Propagation Delay	$V_{\text{S1,2,3}}=0\text{ V}$		130	220	ns
$t_{\text{OFF}}$	Turn-off Propagation Delay	$V_{\text{S1,2,3}}=0\text{ V}$		150	240	ns
$t_{\text{R}}$	Turn-on Rise Time			50	120	ns
$t_{\text{F}}$	Turn-off Fall Time			30	80	ns
MT1	Turn-on Delay Matching $ t_{\text{ON(H)}} - t_{\text{OFF(L)}} $				50	ns
MT2	Turn-off Delay Matching $ t_{\text{OFF(H)}} - t_{\text{ON(L)}} $				50	ns
DT	Dead Time		100	270	440	ns
MDT	Dead-time Matching $ t_{\text{DT1}} - t_{\text{DT2}} $				60	ns

## Typical Characteristics

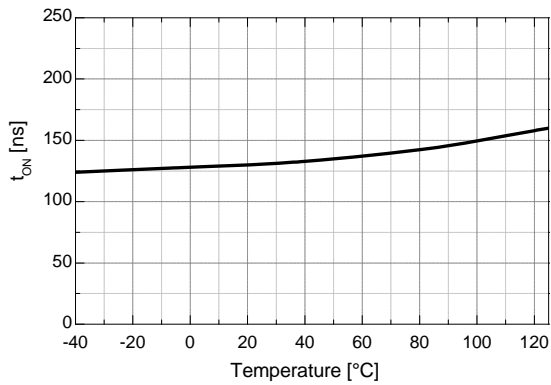

Figure 4. Turn-on Propagation Delay vs. Temp.

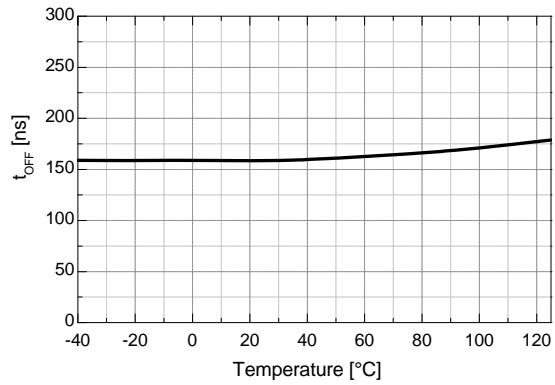

Figure 5. Turn-off Propagation Delay vs. Temp.

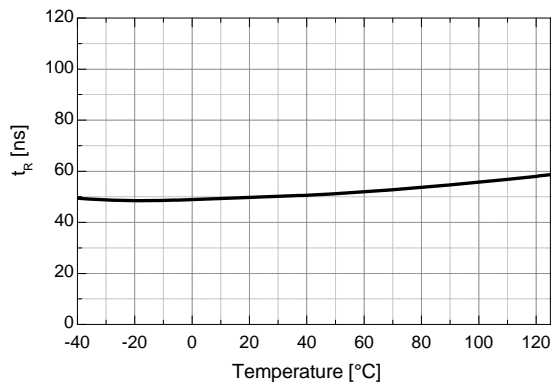

Figure 6. Turn-on Rise Time vs. Temp.

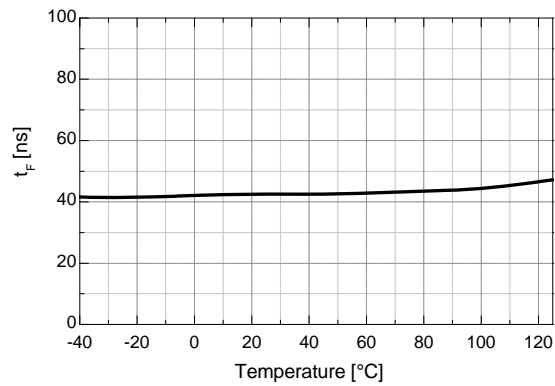

Figure 7. Turn-off Fall Time vs. Temp.

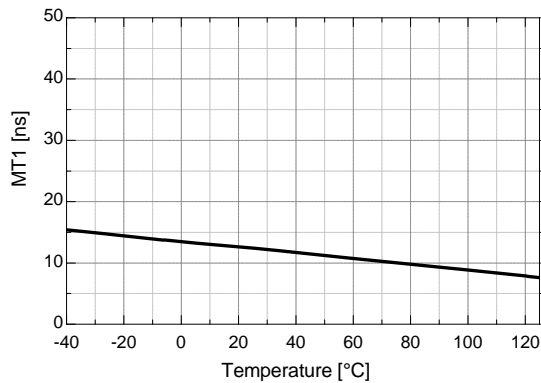

Figure 8. Turn-on Delay Matching vs. Temp.

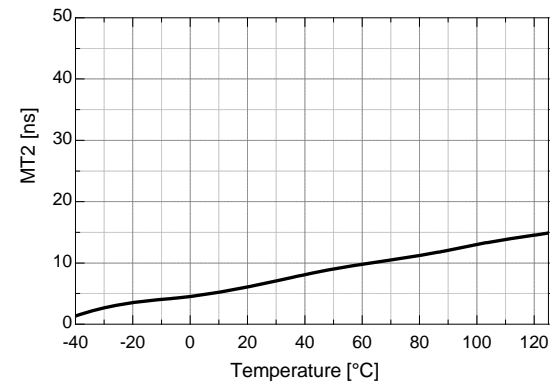

Figure 9. Turn-off Delay Matching vs. Temp.

Typical Characteristics (Continued)

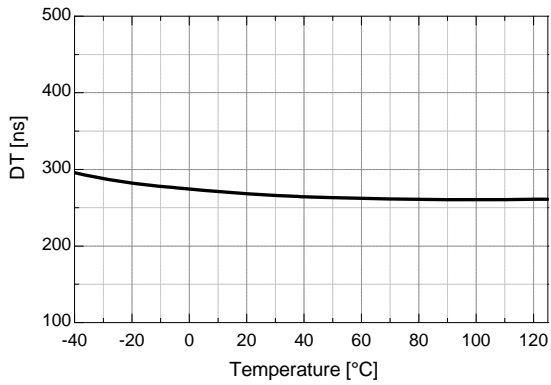

Figure 10. Dead Time vs. Temp.

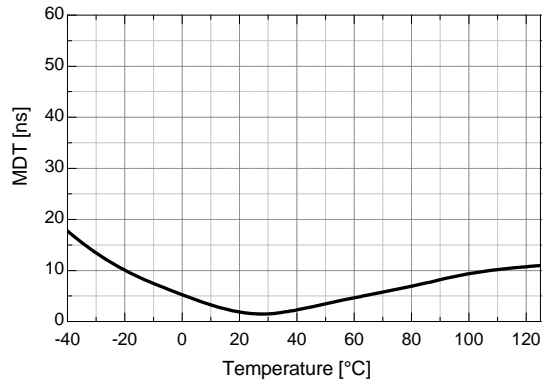

Figure 11. Dead-Time Matching vs. Temp.

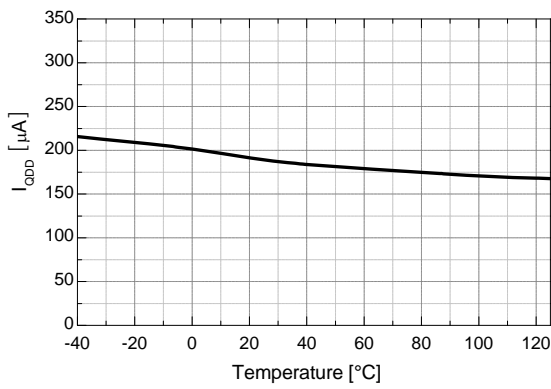

Figure 12. Quiescent V<sub>DD</sub> Supply Current vs. Temp.

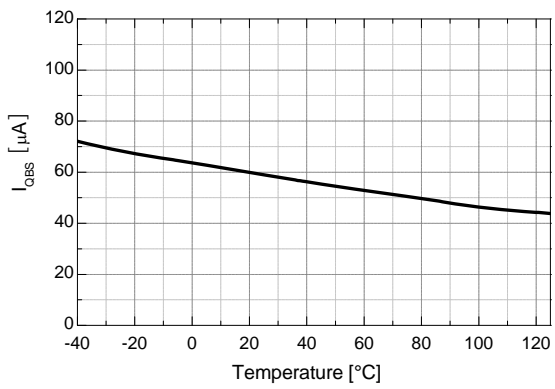

Figure 13. Quiescent V<sub>BS</sub> Supply Current vs. Temp.

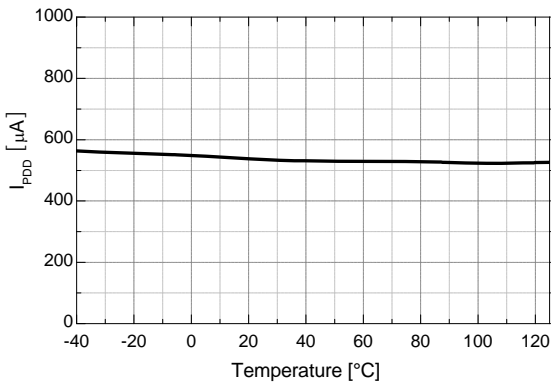

Figure 14. Operating V<sub>DD</sub> Supply Current vs. Temp.

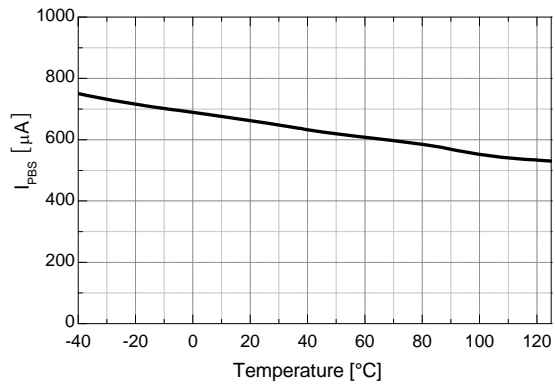

Figure 15. Operating V<sub>BS</sub> Supply Current vs. Temp.



Typical Characteristics (Continued)

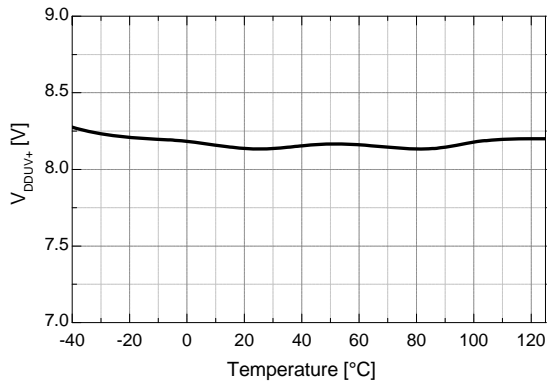

Figure 16. V<sub>DD</sub> UVLO+ vs. Temp.

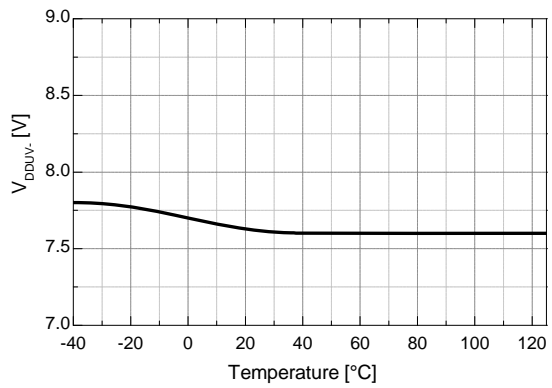

Figure 17. V<sub>DD</sub> UVLO- vs. Temp.

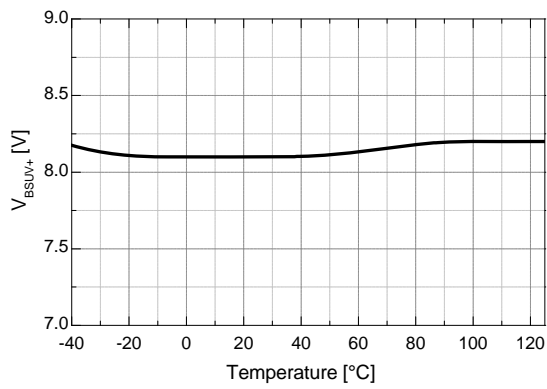

Figure 18. V<sub>BS</sub> UVLO+ vs. Temp.

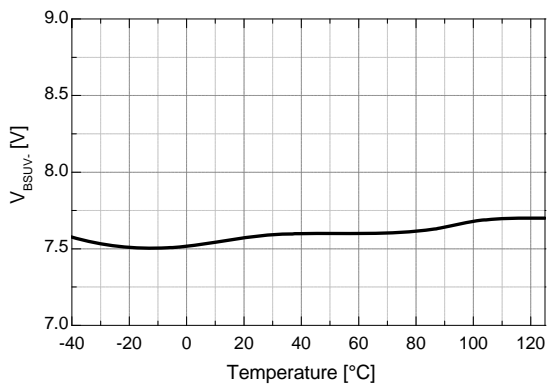

Figure 19. V<sub>BS</sub> UVLO- vs. Temp.

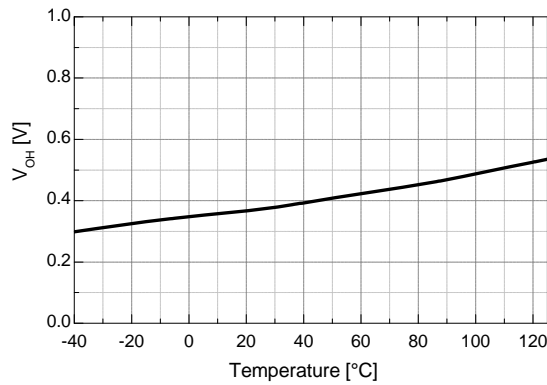

Figure 20. High-Level Output Voltage vs. Temp.

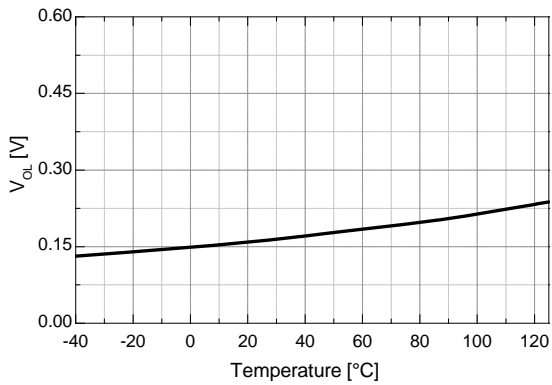

Figure 21. Low-Level Output Voltage vs. Temp.

Typical Characteristics (Continued)

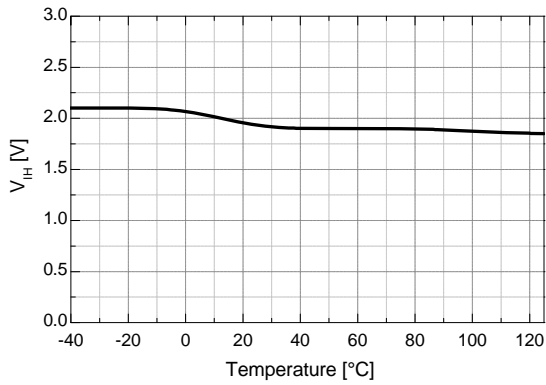

Figure 22. Logic HIGH Input Voltage vs. Temp.

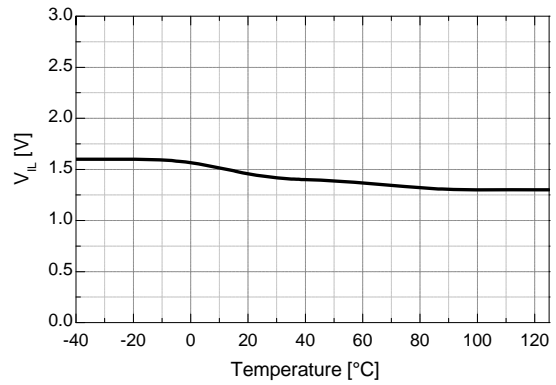

Figure 23. Logic LOW Input Voltage vs. Temp.

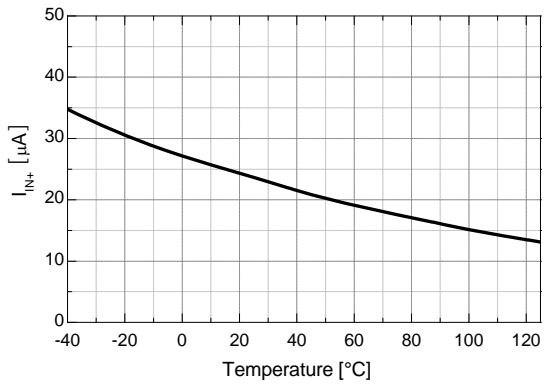

Figure 24. Logic Input High Bias Current vs. Temp.

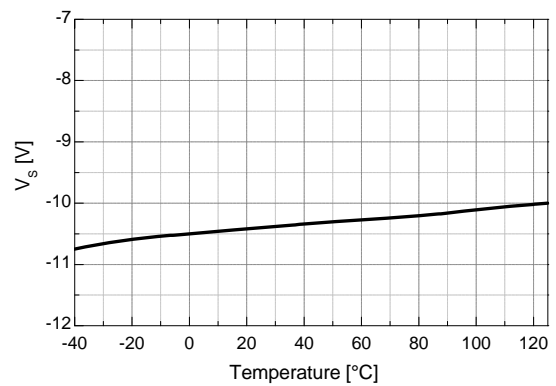

Figure 25. Allowable Negative V<sub>S</sub> Voltage vs. Temp.

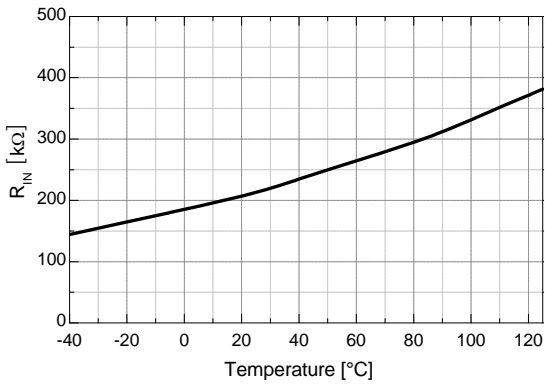

Figure 26. Input Pull-Down Resistance vs. Temp.

## Application Information

### 1. Protection Function

#### 1.1 Under-Voltage Lockout (UVLO)

The high- and low-side drivers include under-voltage lockout (UVLO) protection circuitry for each channel that monitors the supply voltage ( $V_{DD}$ ) and bootstrap capacitor voltage ( $V_{BS1,2,3}$ ) independently. It can be designed to prevent malfunction when  $V_{DD}$  and  $V_{BS1,2,3}$  are lower than the specified threshold voltage. The UVLO hysteresis prevent chattering during power supply transitions.

#### 1.2 Shoot-Through Prevention Function

The FAN7388 has shoot-through prevention circuitry monitoring the high- and low-side control inputs. It can be designed to prevent outputs of high and low side from turning on at same time, as shown Figure 27 and 28.

### 2. Operational Notes

The FAN7388 is a three half-bridge gate driver with internal typically 120 ns dead-time for the three-phase Brushless DC (BLDC) motor drive system, as shown in Figure 1.

Figure 29 shows a switching sequence of 120° electrical commutation for a three-phase BLDC motor drive system.

The waveforms are idealized: they assumed that the generated back EMF waveforms are trapezoidal with flat tops of sufficient width to produce constant torque when the line currents are perfectly rectangular 120° electrical degrees with the switching sequence as shown in Figure 29. The operating waveforms of the wye-connection reveal that repeat every 60 electrical degrees, with each 60° segment being “commutated” to another phase, as shown in Figure 29.

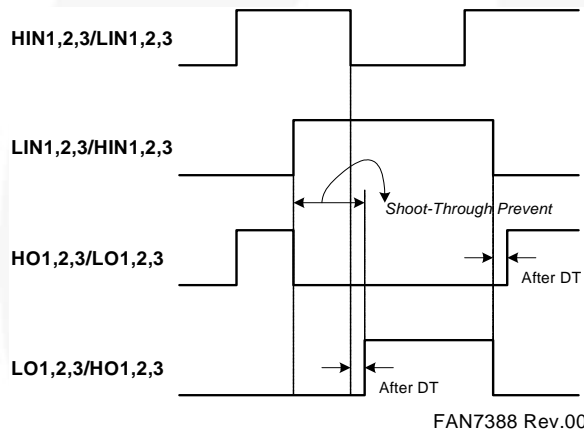

Figure 27. Waveforms for Shoot-Through Prevention

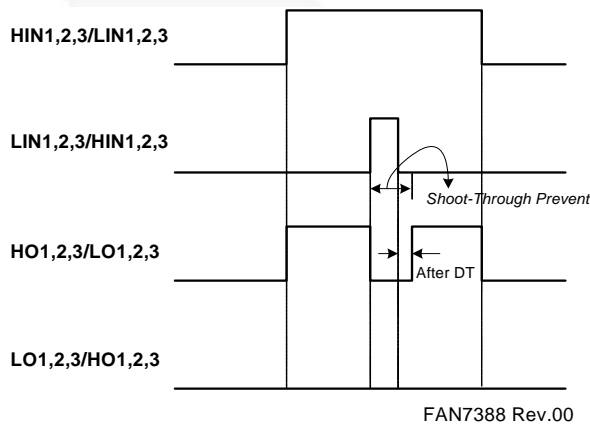

Figure 28. Waveforms for Shoot-Through Prevention

### Application Information (Continued)

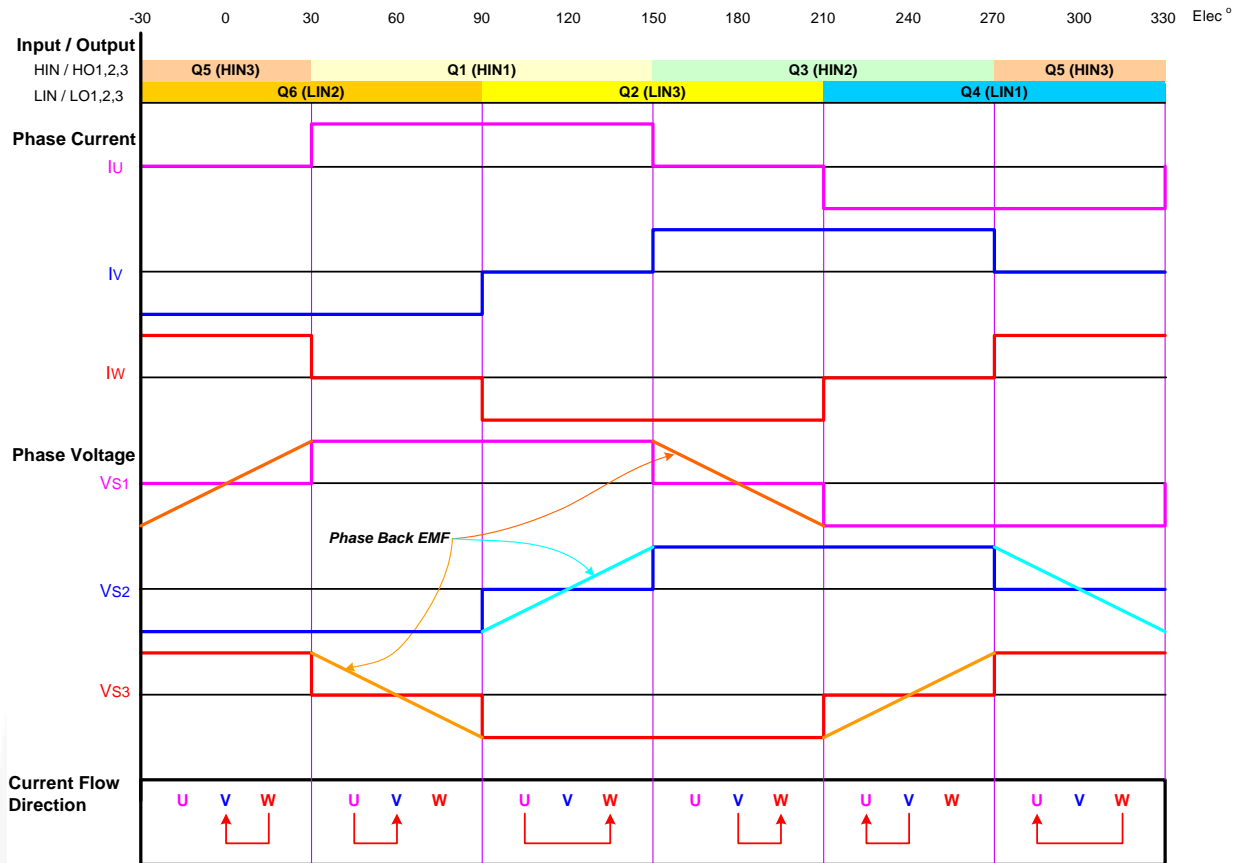

Figure 29. 120° Commutation Operation Waveforms for 3-Phase BLDC Motor Application

### Switching Time Definitions

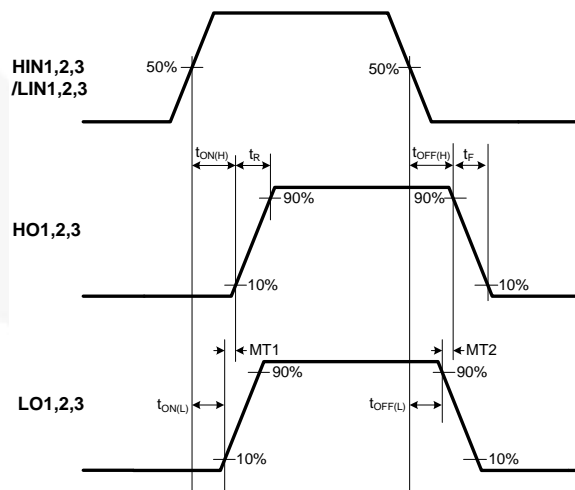

Figure 30. Switching Time Definition





**TRADEMARKS**

The following includes registered and unregistered trademarks and service marks, owned by Fairchild Semiconductor and/or its global subsidiaries, and is not intended to be an exhaustive list of all such trademarks.

- |                          |  |                                       |                  |
|--------------------------|--|---------------------------------------|------------------|
| 2Cool™                   | FPS™   |                                       | Sync-Lock™       |
| AccuPower™               | F-PFS™   | PowerTrench®                          | SYSTEM GENERAL®  |
| AX-CAP®*                 | FRFET®   | PowerXS™                              | TinyBoost™       |
| BitSiC™                  | Global Power Resource™                         | Programmable Active Droop™            | TinyBuck™        |
| Build it Now™            | GreenBridge™                                   | QFET®                                 | TinyCalc™        |
| CorePLUS™                | Green FPS™                                     | QS™                                   | TinyLogic®       |
| CorePOWER™               | Green FPS™ e-Series™                           | Quiet Series™                         | TINYOPTO™        |
| CROSSVOLT™               | Gmax™  | RapidConfigure™                       | TinyPower™       |
| CTL™                     | GTO™   |                                       | TinyPWM™         |
| Current Transfer Logic™  | IntelliMAX™                                    | Saving our world, 1mW/W/kW at a time™ | TinyWire™        |
| DEUXPEED®                | ISOPLANAR™                                     | SignalWise™                           | TranSiC™         |
| Dual Cool™               | Making Small Speakers Sound Louder and Better™ | SmartMax™                             | TriFault Detect™ |
| EcoSPARK®                | MegaBuck™                                      | SMART START™                          | TRUECURRENT®*    |
| EfficientMax™            | MICROCOUPLER™                                  | Solutions for Your Success™           | μSerDes™         |
| ESBC™                    | MicroFET™                                      | SPM®                                  | SerDes®          |
| Fairchild®               | MicroPak™                                      | STEALTH™                              | UHC®             |
| Fairchild Semiconductor® | MicroPak2™                                     | SuperFET®                             | Ultra FRFET™     |
| FACT Quiet Series™       | MillerDrive™                                   | SuperSOT™-3                           | UniFET™          |
| FACT®                    | MotionMax™                                     | SuperSOT™-6                           | VCX™             |
| FAST®                    | mWSaver™                                       | SuperSOT™-8                           | VisualMax™       |
| FastvCore™               | OPTOHi™  | SupreMOS®                             | VoltagePlus™     |
| FETBench™                | OPTOLOGIC®                                     | SyncFET™                              | XS™              |
|                          | OPTOPLANAR®                                    |                                       |                  |

\* Trademarks of System General Corporation, used under license by Fairchild Semiconductor.

**DISCLAIMER**

FAIRCHILD SEMICONDUCTOR RESERVES THE RIGHT TO MAKE CHANGES WITHOUT FURTHER NOTICE TO ANY PRODUCTS HEREIN TO IMPROVE RELIABILITY, FUNCTION, OR DESIGN. FAIRCHILD DOES NOT ASSUME ANY LIABILITY ARISING OUT OF THE APPLICATION OR USE OF ANY PRODUCT OR CIRCUIT DESCRIBED HEREIN; NEITHER DOES IT CONVEY ANY LICENSE UNDER ITS PATENT RIGHTS, NOR THE RIGHTS OF OTHERS. THESE SPECIFICATIONS DO NOT EXPAND THE TERMS OF FAIRCHILD'S WORLDWIDE TERMS AND CONDITIONS, SPECIFICALLY THE WARRANTY THEREIN, WHICH COVERS THESE PRODUCTS.

**LIFE SUPPORT POLICY**

FAIRCHILD'S PRODUCTS ARE NOT AUTHORIZED FOR USE AS CRITICAL COMPONENTS IN LIFE SUPPORT DEVICES OR SYSTEMS WITHOUT THE EXPRESS WRITTEN APPROVAL OF FAIRCHILD SEMICONDUCTOR CORPORATION.

As used herein:

1. Life support devices or systems are devices or systems which, (a) are intended for surgical implant into the body or (b) support or sustain life, and (c) whose failure to perform when properly used in accordance with instructions for use provided in the labeling, can be reasonably expected to result in a significant injury of the user.
2. A critical component in any component of a life support, device, or system whose failure to perform can be reasonably expected to cause the failure of the life support device or system, or to affect its safety or effectiveness.

**ANTI-COUNTERFEITING POLICY**

Fairchild Semiconductor Corporation's Anti-Counterfeiting Policy. Fairchild's Anti-Counterfeiting Policy is also stated on our external website, [www.fairchildsemi.com](http://www.fairchildsemi.com), under Sales Support.

Counterfeiting of semiconductor parts is a growing problem in the industry. All manufacturers of semiconductor products are experiencing counterfeiting of their parts. Customers who inadvertently purchase counterfeit parts experience many problems such as loss of brand reputation, substandard performance, failed applications, and increased cost of production and manufacturing delays. Fairchild is taking strong measures to protect ourselves and our customers from the proliferation of counterfeit parts. Fairchild strongly encourages customers to purchase Fairchild parts either directly from Fairchild or from Authorized Fairchild Distributors who are listed by country on our web page cited above. Products customers buy either from Fairchild directly or from Authorized Fairchild Distributors are genuine parts, have full traceability, meet Fairchild's quality standards for handling and storage and provide access to Fairchild's full range of up-to-date technical and product information. Fairchild and our Authorized Distributors will stand behind all warranties and will appropriately address any warranty issues that may arise. Fairchild will not provide any warranty coverage or other assistance for parts bought from Unauthorized Sources. Fairchild is committed to combat this global problem and encourage our customers to do their part in stopping this practice by buying direct or from authorized distributors.

**PRODUCT STATUS DEFINITIONS**

**Definition of Terms**

Datasheet Identification	Product Status	Definition
Advance Information	Formative / In Design	Datasheet contains the design specifications for product development. Specifications may change in any manner without notice.
Preliminary	First Production	Datasheet contains preliminary data; supplementary data will be published at a later date. Fairchild Semiconductor reserves the right to make changes at any time without notice to improve design.
No Identification Needed	Full Production	Datasheet contains final specifications. Fairchild Semiconductor reserves the right to make changes at any time without notice to improve the design.
Obsolete	Not In Production	Datasheet contains specifications on a product that is discontinued by Fairchild Semiconductor. The datasheet is for reference information only.

Rev. I64