

System Power Supply for TV Series

FET Controller Type 3ch System Power Supply ICs



BD8621EFV

No.09034EAT03

●Description

BD8621EFV has realized the high performance and reliability required as a power supply for thin-screen TV.

With built-in FET 1ch current mode control, the DC/DC Converter series has the advantage of high-speed load response and wide phase margin.

Due to the high-speed load response, it is most suitable for TV-purpose processors with increasingly high performance, and due to the wide phase margin it leaves a good margin for board pattern & constant setting and so facilitates its application design.

As a high-reliability design, it has various built-in protection circuits (overcurrent protection, output voltage abnormal protection, thermal protection, and off-latch function at the time of abnormality etc.), therefore as an advantage it does not easily damage in every possible abnormal condition such as all-pin short circuit test etc. and hence most suitable for thin-screen TV which requires the high reliability.

●Features

- 1) 3A output current
- 2) Low RDS(ON) internal switches (PchMOS:75mΩ, NchMOS:55mΩ)
- 3) ±1% reference voltage accuracy
- 4) Programmable frequency : 250kHz-1MHz
- 5) (Frequency in programmable by adjusting RT resistance or synchronizing with SYNCLK terminal.)
- 6) Terminal RT OPEN/SHORT detecting function
- 7) Over current protection function
- 8) Output over voltage/low voltage protection function (over : $FB > VREF + 60mV$, low : $FB < VREF - 60mV$)
- 9) Timer off latch function in abnormal circumstances
- 10) Thermal shutdown function
- 11) Under voltage protection
- 12) Soft start/start delay circuit
- 13) Soft start time out function
- 14) Protecting BUS function with terminal PDET
- 15) HTSSOP-B20 package

●Electrical characteristics

(Unless otherwise noted Ta=25°C, VIN=3.3V, GND=0V)

Parameter	Symbol	Specification value			UNIT	Condition
		MIN	TYP	MAX		
VIN supply current (operating)	I _{Q_active}	-	220	350	μA	V _{FB} = 0.83V, V _{FC} = 1V
VIN supply current (standby)	I _{Q_stby}	-	0	1	μA	V _{EN} = 0V
Reference voltage (VREF)	V _{REF}	0.792	0.8	0.808	V	
Output rise detection voltage	V _{OVP}	30	60	90	mV	Monitoring FB terminal
Output decrease detection voltage	V _{LVP}	-90	-60	-30	mV	Monitoring FB terminal
Terminal PDET output current	I _{PDET}	0.4	-	-	mA	V _{PDET} < 0.3V
Oscillation frequency	f _{OSC}	500	550	600	kHz	R _{RT} = 220kΩ
Pch FET ON resistance	R _{PFET}	-	75	110	mΩ	I _{SW} = 1A
Nch FET ON resistance	R _{NFET}	-	55	90	mΩ	I _{SW} = 1A
UVLO voltage	V _{UVLO}	2.35	2.50	2.65	V	
SW leak current	I _{LSW}	-	0	1	μA	V _{EN} = 0V, V _{IN} = 5.5V
EN terminal H threshold voltage	V _{ENH}	1.1	-	-	V	
EN terminal L threshold voltage	V _{ENL}	-	-	0.4	V	
FC sink current	I _{FCSI}	10	20	-	μA	
FC source current	I _{FCSO}	-	-20	-10	μA	
SS/DELAY terminal source current	I _{SSSO}	2	4	6	μA	
Terminal PDET pull-up resistor	R _{PDET}	100	170	250	kΩ	

V_{FB}:FB terminal voltage, V_{EN}:EN terminal voltage, V_{FC}:FC terminal voltage, V_{PDET}: PDET terminal voltage
Current capability should not exceed Pd.

●Block Diagram

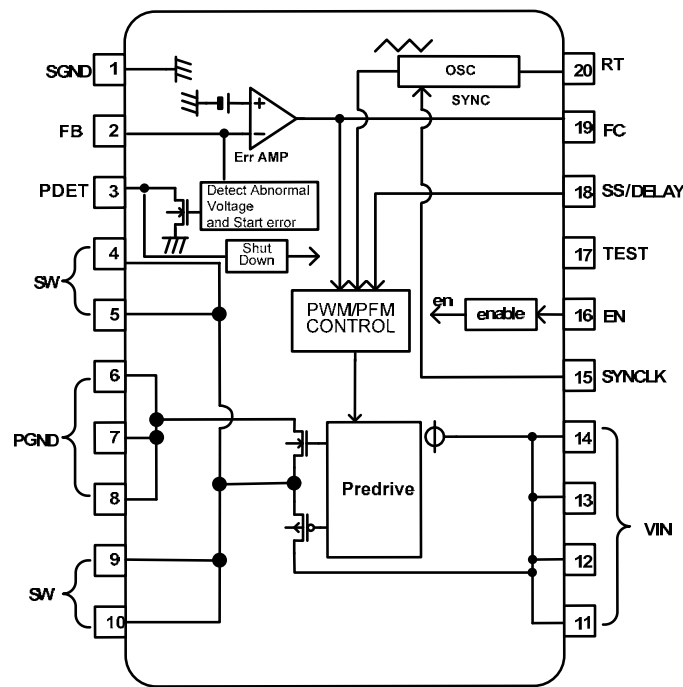

Fig1 Block diagram

●Pin Description

No.	Symbol	Description	Explanation
1	SGND	Signal GND terminal	Small signal system GND
2	FB	Feed back terminal	Output voltage detection
3	PDET	Off latch signal output	Protecting BUS communication terminal
4	SW	Output terminal	Switching output
5	SW		
6	PGND	Power GND terminal	GND for power MOSFET
7	PGND		
8	PGND		
9	SW	Output terminal	Power Mos output
10	SW		
11	VIN	Power supply input terminal	Power supply input. The decoupling is done to PGND
12	VIN		
13	VIN		
14	VIN		
15	REG	Internal Regulator	Synchronizable switching output terminal frequency with external clock
16	EN	Enable input	ON/OFF control for device operation
17	TEST	Terminal for test	SGND short in the set.
18	SS/DELAY	Soft start adjustment capacity connection terminal	The soft start time is adjusted with the connected capacitor
19	FC	Error amplifier output	Error amplifier phase compensation point
20	RT	Frequency adjustment resistance connection terminal	The switching frequency is set by the connected resistance

●Pin equivalence circuit diagram

No.	Symbol	Explanation	Terminal equivalent circuit diagram
1	SGND	GND (connected 0V)	
2	FB	Output voltage detection terminal	
3	PDET	Protecting BUS I/O terminal	
4,5,9,10	SW	Output terminal	
6,7,8	PGND	Power GND (Same voltage as SGND)	
11,12,13,14	VIN	Power supply input terminal	

No.	Symbol	Explanation	Terminal equivalent circuit diagram
15	REG	Internal Regulator output voltage	<p>The diagram shows a central node labeled '15'. This node is connected to the gate of a MOSFET. A resistor is connected between this node and a ground symbol labeled 'SGND'. A diode is connected between the node and a terminal labeled 'VIN'. Another diode is connected between the node and another 'SGND' ground symbol.</p>
16	EN	Enable terminal	<p>The diagram shows a central node labeled '16'. This node is connected to the anode of a diode that goes to a terminal labeled 'VIN'. The cathode of this diode is connected to a ground symbol labeled 'SGND'. The node is also connected to the gate of a MOSFET through a resistor. Another resistor connects the node to the gate of a second MOSFET. The source of this second MOSFET is connected to a ground symbol labeled 'SGND'.</p>
17	TEST	Using at test mode	<p>The diagram shows a central node labeled '17'. This node is connected to the anode of a diode that goes to a terminal labeled 'VIN'. The cathode of this diode is connected to a ground symbol labeled 'SGND'. The node is also connected to the gate of a MOSFET through a resistor. Another resistor connects the node to the gate of a second MOSFET. The source of this second MOSFET is connected to a ground symbol labeled 'SGND'.</p>

No.	Symbol	Explanation	Terminal equivalent circuit diagram
18	SS /DELAY	Soft start time adjustment terminal	
19	FC	Error amplifier compensation terminal	
20	RT	Oscillator frequency adjustment terminal	

●Operation description

Enable control

The device can be controlled ON/OFF by EN terminal (16 pin) voltage.
An internal circuit starts when VEN reaches 1.1V.

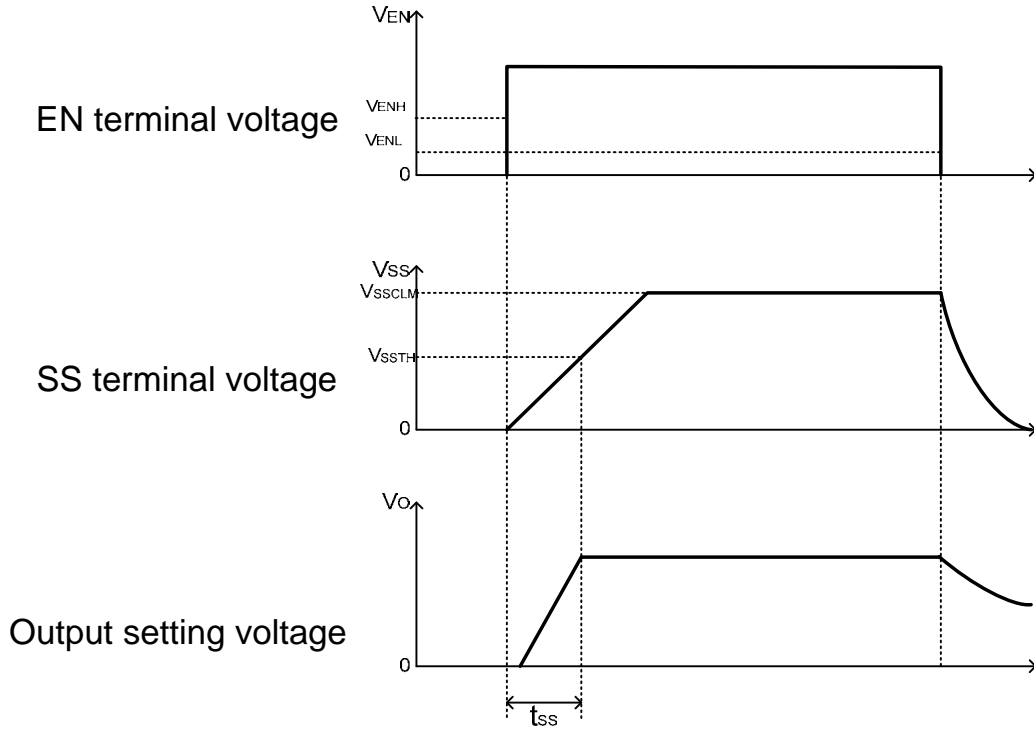

Fig.2 ON/OFF transition wave form in EN controlling

Soft start time set function

As for BD8621EFV, output can do soft start without overshoot by charging soft start capacity (CSS) connected between SS and SGND terminal.

Also, soft start time (tss) can be set by setting soft start capacity (CSS) arbitrarily.

OSC oscillation frequency setting function

The output oscillation frequency can be set by connecting resistance between terminal RT (20 pins) and SGND (range = 250kHz - 1MHz)

The relation between RT terminal resistance and the oscillation frequency follows Fig.3.

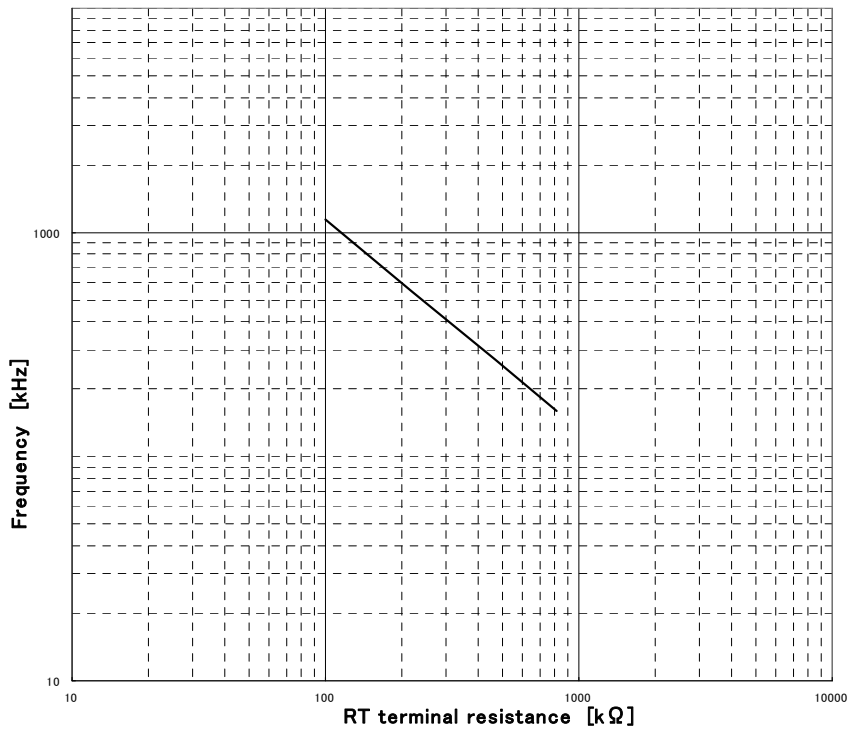

Fig.3 RT resistance-oscillation frequency

Switching frequency synchronization

An internal transmitter of BD8621EFV can be synchronized with the external clock signal connected with the terminal SYNCLK (15 pins).

The frequency of external clock can be set within the range of 250kHz-1MHz. In this case, please set the RT resistance that may become about -20% value of the external clock frequency.

* Be short-circuited SYNCLK terminal to SGND when a frequency synchronous function is not used.

●Protection function

Protection circuit is effective for destruction prevention due to accident so that avoid using under continuous protection operation.

Low voltage protection function (LVP)

The voltage of the terminal FB (2 pins) is compared with internal reference voltage VREF. If FB terminal voltage falls below $V_{LVP}(= VREF -60mV)$ and the state continues for 500us, output changes to low voltage and the state is fixed. In that case , PDET (3pin) output changes to L.

Table 1 output low voltage protection function

EN terminal	SS terminal	FB terminal	Low voltage protection function	Low voltage protection operation
$>V_{ENH}$	$>1.4V(typ)$	$<V_{LVP}$	Effective	ON
		$>V_{LVP}$		OFF
$<V_{ENL}$	$<1.4V(typ)$	-	Invalidity	OFF
	-	-	Invalidity	OFF

* Low voltage protection function is available when SS terminal voltage becomes more than 1.4V (typ) in the transition to ON control (during soft start).

Over voltage protection function(OVP)

The voltage of the terminal FB is compared with internal reference voltage VREF. If FB terminal voltage is over $V_{ovp}(=VREF +60mV)$ and the state is continues for 500usec, output changes to low voltage and the state is fixed.

Table 2 output overvoltage protection function

EN terminal	SS terminal	FB terminal	Over voltage protection function	Over voltage protection operation
$>V_{ENH}$	$>1.4V(typ)$	$>V_{OVP}$	Effective	ON
		$<V_{OVP}$		OFF
$<V_{ENL}$	$<1.4V(typ)$	-	Invalidity	OFF
	-	-	Invalidity	OFF

* Over voltage protection function is available when SS terminal voltage becomes more than 1.4V (typ) in the transition to ON control (during soft start).

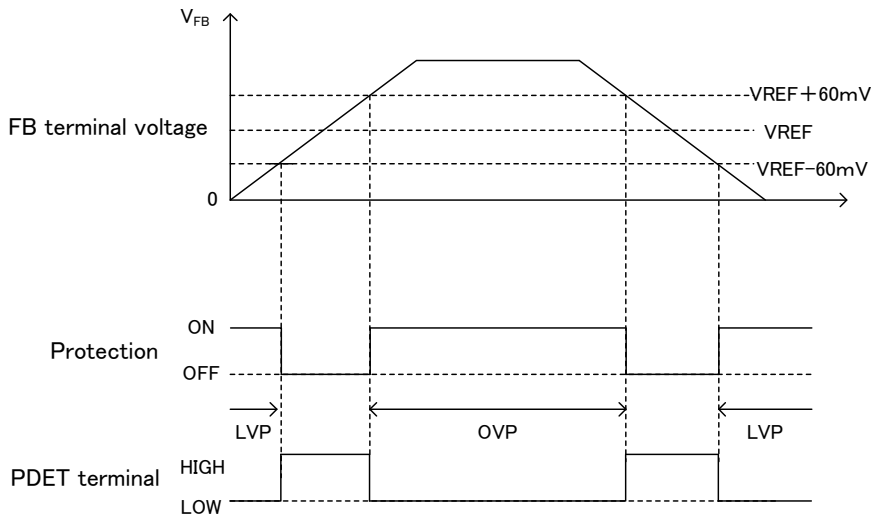

Fig.4 Output voltage error detection range

Under voltage lock out protection (UVLO)

As for BD8621EFV, the power-supply voltage decrease detection protection circuit is built in.

If the input voltage decrease below the UVLO voltage (2.5V typ), the device state changes to the standby mode (Moreover, to prevent the chattering of the output) hysteresis width of 100mV(typ) has been installed in the UVLO cancel voltage.

RT terminal open/short protection function (RTO/RTS)

RT terminal opening/short protection function prevent the clock from abnormal oscillation.

If RT terminal open/short protection function is detected, output voltage changes to low level and is fixed.

Terminal RT opening/short protection function is available if the state continue for 500usec, abnormal detection operates when the state continues about 500µsec(typ).

Soft start time-out function

If VSS doesn't exceed VSSTH within 64msec (typ) since a soft start began, BD8621EFV controls an off latch.

Vo is fixed in a low level.

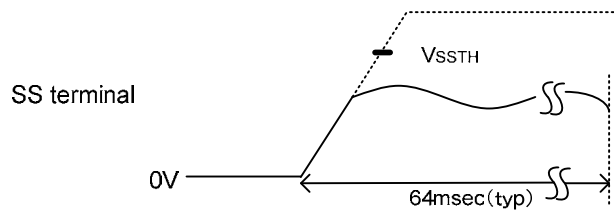

Fig.5 Soft start time-out

Thermal shut down function

Thermal shut down circuit (TSD circuit) is built into BD8621EFV. When the temperature of the chip exceeds $T_{jmax}=175$, the DC/DC converter is fixed in a low voltage.

TSD function is aimed to shut down IC from thermal reckless driving under an abnormal state to exceed $T_{jmax}=175$.

It aims at neither protection nor the guarantee of the set. Therefore, please do not use this function to protect the set.

Over current protection function

The over current protection function has been achieved by limiting the current that flows on high side MOSFET.

The current is controlled in every one cycle of the switching frequency. When an abnormal state continues for about 500µsec(typ), the output is fixed in a low level.

Protecting BUS function with terminal PDET

The terminal PDET (3 pins) monitors whether IC is normal or not. When IC becomes abnormal, the PDET output is reduced at "L" level with the output voltage fixed "L" level at the same time. Moreover, it is possible to make the output fix in a low level by compulsorily reducing the terminal PDET at "L" level from the outside.

When two or more BD8621EFV is used in the application, this function prevents the IC from destroying, because one IC error transmits all other ICs by PDET line in the condition that PDET terminals are connected each other.

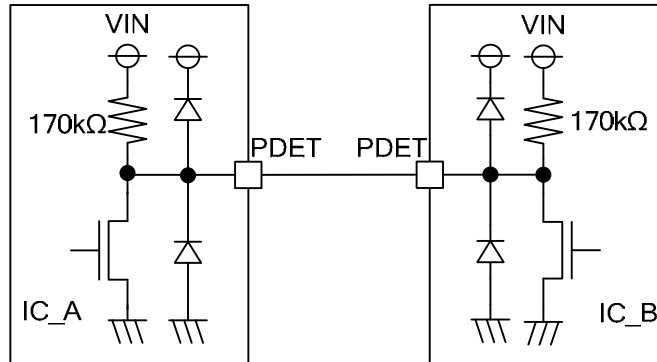

Fig.6 Protecting BUS communication

※Please give the terminal PDET as OPEN when you do not use protecting BUS function.

Error detection (off latch) release method

BD8621EFV enters the state of an off latch when the protection function operates.

To release the off latch state, EN terminal voltage should be changed to low level once time.

● Each characteristic reference data

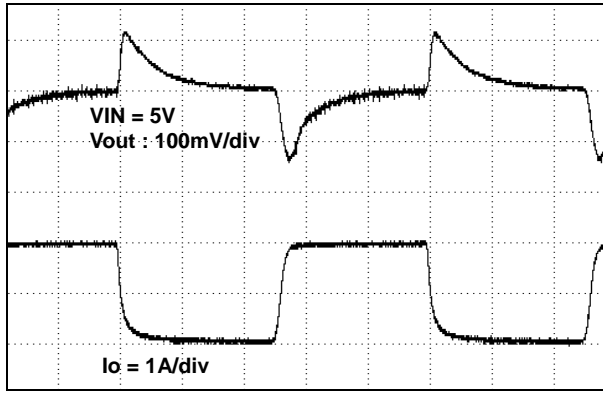

Fig.7 Output load response

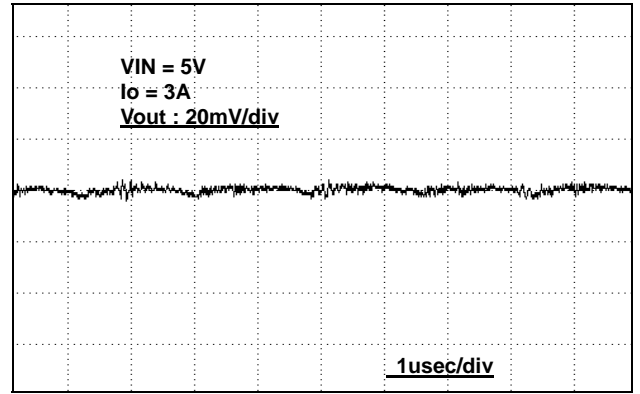

Fig.8 Output ripple

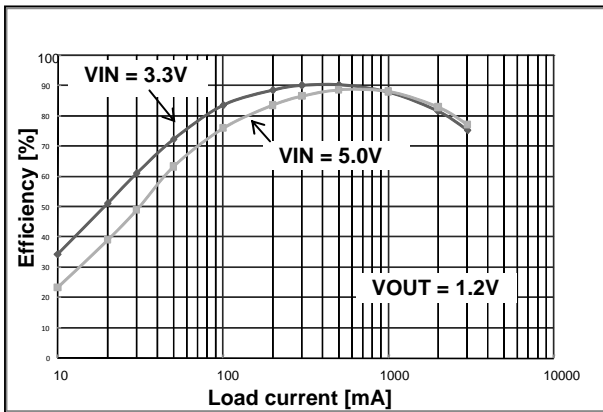

Fig.9 Efficiency

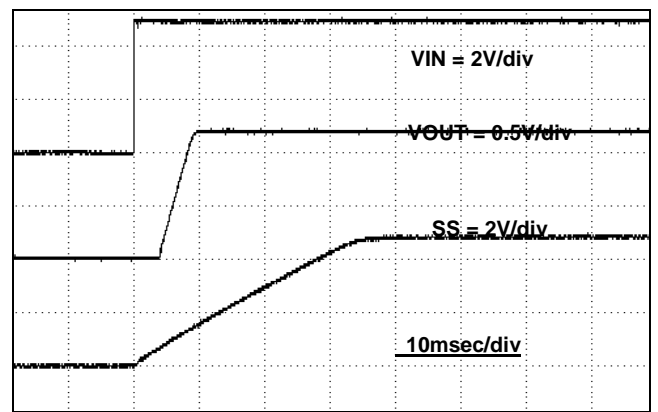

Fig.10 Soft start

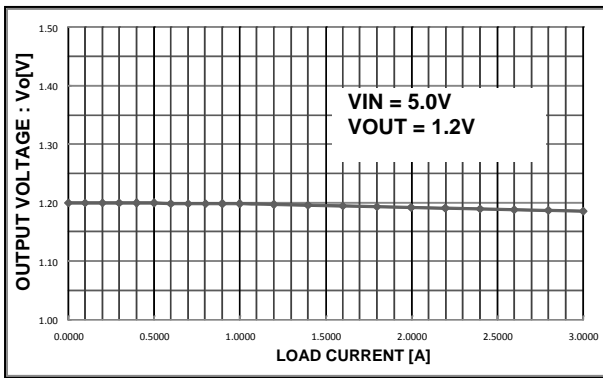

Fig.11 Regulation

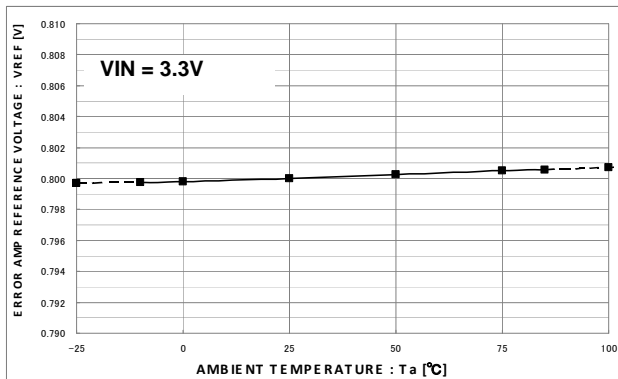

Fig.12 Reference voltage - Temperature characteristic

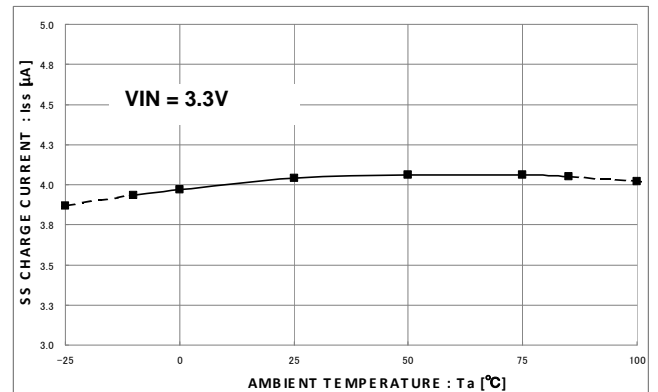

Fig.13 SS Charging current - Temperature characteristic

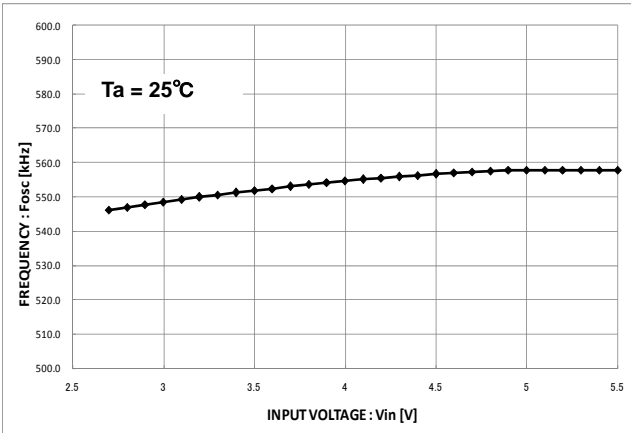

Fig.14 Switching frequency-power-supply voltage

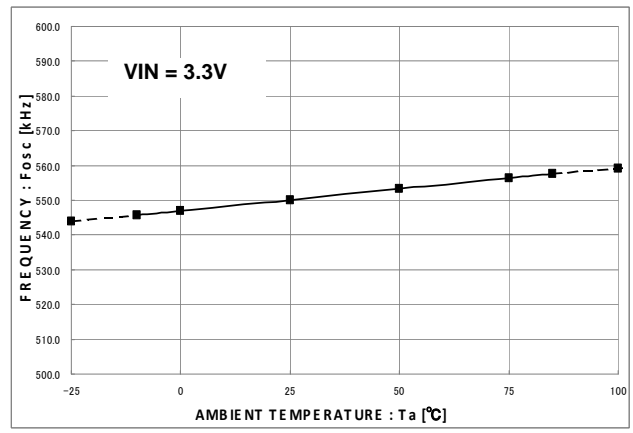

Fig.15 Switching frequency-temperature characteristic

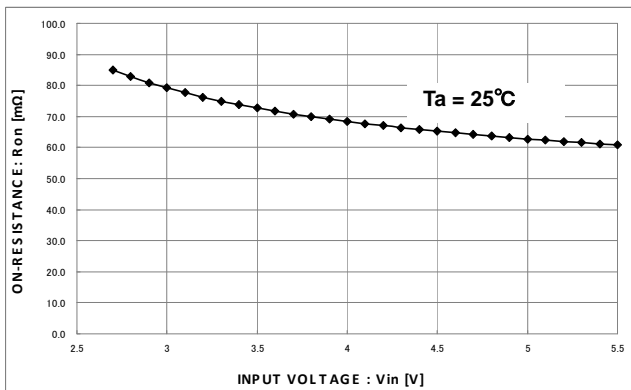

Fig.16 PMOS on resistance-power-supply voltage

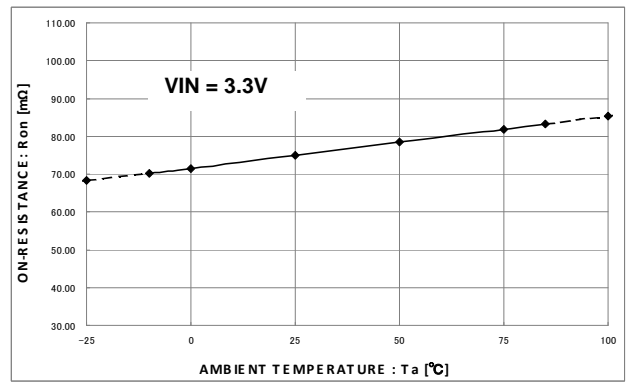

Fig.17 PMOS on resistance-temperature characteristic

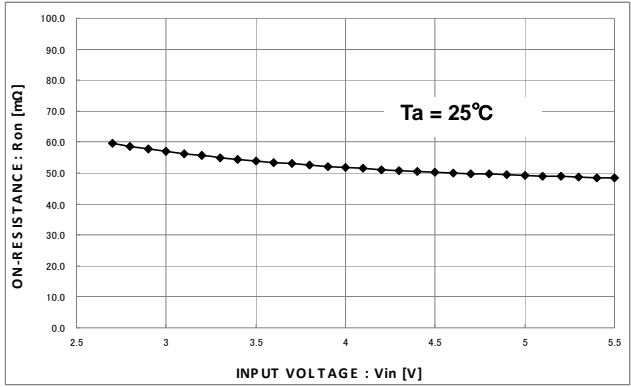

Fig.18 NMOS on resistance-power-supply voltage

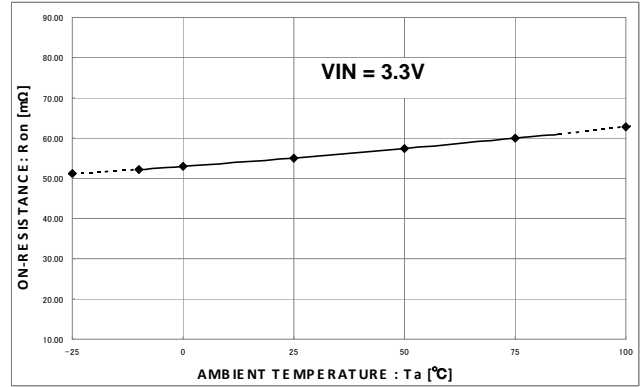

Fig.19 NMOS on resistance-temperature characteristic

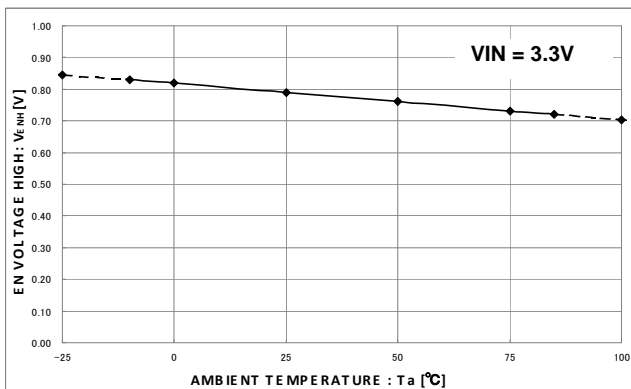

Fig.20 Terminal EN H voltage-temperature characteristic

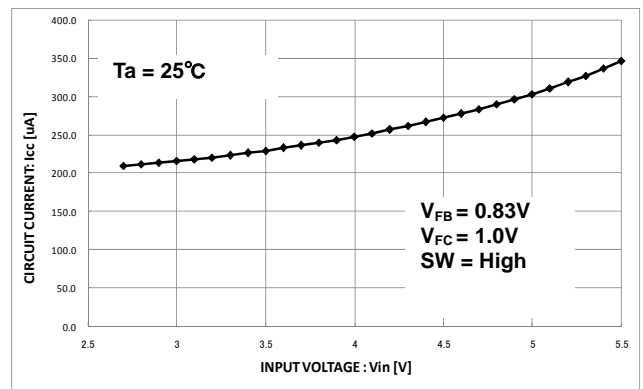

Fig.21 Circuit current-power-supply voltage characteristic

●Ordering part number

B	D
---	---

Part No

8	6	2	1
---	---	---	---

Part No.

E	F	V
---	---	---

Package
EFV: HTSSOP-B20

E	2
---	---

Packaging and forming specification
E2: Embossed tape and reel

HTSSOP-B20

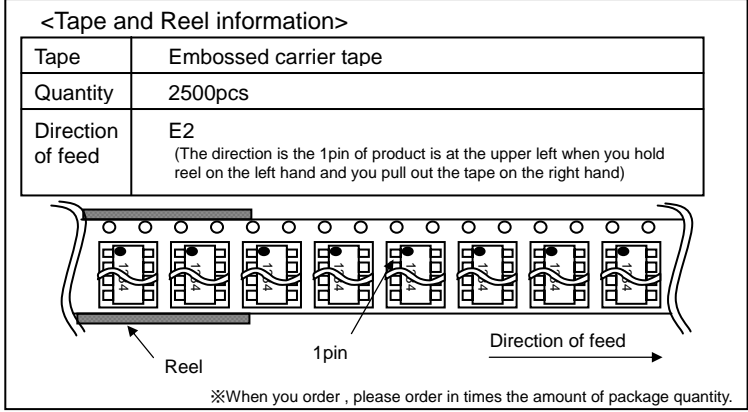
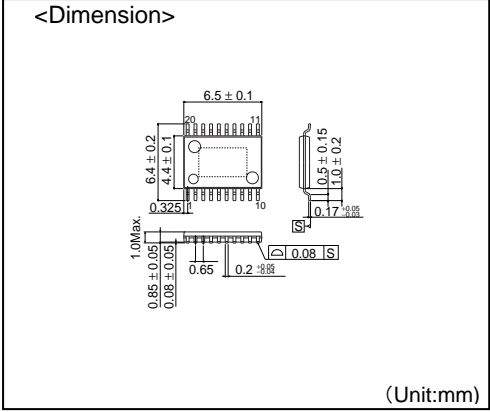

Notes

No copying or reproduction of this document, in part or in whole, is permitted without the consent of ROHM Co.,Ltd.

The content specified herein is subject to change for improvement without notice.

The content specified herein is for the purpose of introducing ROHM's products (hereinafter "Products"). If you wish to use any such Product, please be sure to refer to the specifications, which can be obtained from ROHM upon request.

Examples of application circuits, circuit constants and any other information contained herein illustrate the standard usage and operations of the Products. The peripheral conditions must be taken into account when designing circuits for mass production.

Great care was taken in ensuring the accuracy of the information specified in this document. However, should you incur any damage arising from any inaccuracy or misprint of such information, ROHM shall bear no responsibility for such damage.

The technical information specified herein is intended only to show the typical functions of and examples of application circuits for the Products. ROHM does not grant you, explicitly or implicitly, any license to use or exercise intellectual property or other rights held by ROHM and other parties. ROHM shall bear no responsibility whatsoever for any dispute arising from the use of such technical information.

The Products specified in this document are intended to be used with general-use electronic equipment or devices (such as audio visual equipment, office-automation equipment, communication devices, electronic appliances and amusement devices).

The Products specified in this document are not designed to be radiation tolerant.

While ROHM always makes efforts to enhance the quality and reliability of its Products, a Product may fail or malfunction for a variety of reasons.

Please be sure to implement in your equipment using the Products safety measures to guard against the possibility of physical injury, fire or any other damage caused in the event of the failure of any Product, such as derating, redundancy, fire control and fail-safe designs. ROHM shall bear no responsibility whatsoever for your use of any Product outside of the prescribed scope or not in accordance with the instruction manual.

The Products are not designed or manufactured to be used with any equipment, device or system which requires an extremely high level of reliability the failure or malfunction of which may result in a direct threat to human life or create a risk of human injury (such as a medical instrument, transportation equipment, aerospace machinery, nuclear-reactor controller, fuel-controller or other safety device). ROHM shall bear no responsibility in any way for use of any of the Products for the above special purposes. If a Product is intended to be used for any such special purpose, please contact a ROHM sales representative before purchasing.

If you intend to export or ship overseas any Product or technology specified herein that may be controlled under the Foreign Exchange and the Foreign Trade Law, you will be required to obtain a license or permit under the Law.



Thank you for your accessing to ROHM product informations.
More detail product informations and catalogs are available, please contact us.

ROHM Customer Support System

<http://www.rohm.com/contact/>