

SANYO Semiconductors

DATA SHEET

An ON Semiconductor Company

LV5026M — Bi-CMOS IC LED Driver IC

Overview

LV5026M is a High Voltage LED drive controller which drives LED current up to 3A with external MOSFET. LV5026M is realized very simple LED circuits with a few external parts. It corresponds to various wide dimming controls including the TRIAC dimming control.

Functions

- High Voltage LED Controller
- Various Dimming Control
 - TRIAC & Analog Input & PWM Input
- Soft Start function
- Built-in TRIAC stabilized function
- Built-in circuit of detection of overvoltage of CS pin.
- Selectable Switching frequency [50 kHz or 70 kHz, open: 50 kHz]
- Short Protection Circuit
- Selectable reference Voltage
 - Internal 0.605V & External Input Voltage
- Low noise switching system
 - 5 stages skip mode Frequency
 - Soft driving

Specifications

Maximum Ratings at Ta = 25°C

Parameter	Symbol	Conditions	Ratings	Unit
Maximum Input voltage	V _{IN} max		-0.3 to 42	V
REF_OUT, REF_IN, RT, CS, PWM_D, ACS			-0.3 to 7	V
OUT1 pin	V _{OUT_abs}		-0.3 to 42	V
OUT2 pin	V _{OUT2_abs}		-0.3 to 42	V
Allowable power dissipation	P _d max	With specified board*	1.0	W
Junction temperature	T _j		150	°C
Operating temperature	T _{opr}		-30 to +125	°C
Storage temperature	T _{stg}		-40 to +150	°C

*Specified board: 58.0×54.0×1.6mm (glass epoxy board)

- Any and all SANYO Semiconductor Co.,Ltd. products described or contained herein are, with regard to "standard application", intended for the use as general electronics equipment (home appliances, AV equipment, communication device, office equipment, industrial equipment etc.). The products mentioned herein shall not be intended for use for any "special application" (medical equipment whose purpose is to sustain life, aerospace instrument, nuclear control device, burning appliances, transportation machine, traffic signal system, safety equipment etc.) that shall require extremely high level of reliability and can directly threaten human lives in case of failure or malfunction of the product or may cause harm to human bodies, nor shall they grant any guarantee thereof. If you should intend to use our products for applications outside the standard applications of our customer who is considering such use and/or outside the scope of our intended standard applications, please consult with us prior to the intended use. If there is no consultation or inquiry before the intended use, our customer shall be solely responsible for the use.
- Specifications of any and all SANYO Semiconductor Co.,Ltd. products described or contained herein stipulate the performance, characteristics, and functions of the described products in the independent state, and are not guarantees of the performance, characteristics, and functions of the described products as mounted in the customer's products or equipment. To verify symptoms and states that cannot be evaluated in an independent device, the customer should always evaluate and test devices mounted in the customer's products or equipment.

LV5026M

Recommended Operating Conditions at Ta = 25°C

Parameter	Symbol	Conditions	Ratings	Unit
Input voltage	V _{IN}		8.5 to 24	V

Electrical Characteristics at Ta = 25°C, V_{IN} = 12V, unless otherwise specified.

Parameter	Symbol	Conditions	Ratings			Unit
			min	typ	max	
Reference Voltage block						
Built-in Reference Voltage	VREF		0.585	0.605	0.625	V
VREF V _{IN} line regulation	VREF_LN	V _{IN} = 8.5 to 24V		±0.5		%
Reference Output Voltage	REFOUT	I _{REFOUT} = 0.5mA		3.0		V
- Maximum load	REFOUT_MAX		0.5			mA
- equivalent output impedance	REFOUT_RO			10		Ω
Under Voltage Lockout						
Operation Start Input Voltage	UVLOON		8	9	10	V
Operation Stop Input Voltage	UVLOOFF		6.3	7.3	8.3	V
Hysteresis Voltage	UVLOH			1.7		V
Oscillation						
Frequency	FOSC1	RT = OPEN	40	50	60	kHz
	FOSC2	RT=REF_OUT	55	70	85	kHz
FOSC1 Switch voltage	VOSC1		2		5	V
FOSC2 Switch voltage	VOSC2				0.5	V
Maximum ON duty	MAXDuty			93		%
Comparator						
Input offset Voltage (Between CS and VREF)	V _{IO_VR}			1	10	mV
Input offset Voltage (Between CS and REFOUT)	V _{IO_RI}			1	10	mV
Input current	I _{IOCS}			160		nA
	I _{IOREF}			80		nA
CS pin max voltage	VOM				1	V
malfunction prevention mask time	TMSK			150		ns
PWM_D Circuit						
OFF voltage	V _{OFF}		2		5	V
ON voltage	V _{ON}		0		0.6	V
Thermal protection Circuit						
Thermal shutdown temperature	TSD	*Design guarantee		165		°C
Thermal shutdown hysteresis	ΔTSD	*Design guarantee		30		°C
Drive Circuit						
OUT sink current	I _O I		500	1000		mA
OUT source current	I _O O			120		mA
Minimum On time	T _{MIN}			200	300	ns
TRIAC Stabilization Circuit						
Threshold of OUT2	VACS	OUT2=High [less than right record]	2.8	3.0	3.2	V
OUT2 sink current	I _{O2} I	V _{IN} =12V, OUT2=6V		0.6		mA
OUT2 source current	I _{O2} O	V _{IN} =12V, OUT2=6V		0.6		mA
V_{CC} current						
UVLO mode V _{IN} current	I _{CCOFF}	V _{IN} <UVLOON		80	120	μA
Normal mode V _{IN} current	I _{CCON}	V _{IN} >UVLOON, OUT = OPEN		0.6		mA

LV5026M

V_{IN} Over Voltage Protection Circuit						
V _{IN} over voltage protection voltage	V _{INOVP}		24	27	30	V
V _{IN} Current at OVP	I _{INOVP}	V _{IN} =30V	0.7	1.0	1.5	mA
CS terminal abnormal sensing circuit						
Abnormal sensing voltage	CSOCP			1.9		V

*: Design guarantee (value guaranteed by design and not tested before shipment)

LV5026M

TYPICAL CHARACTERISTICS

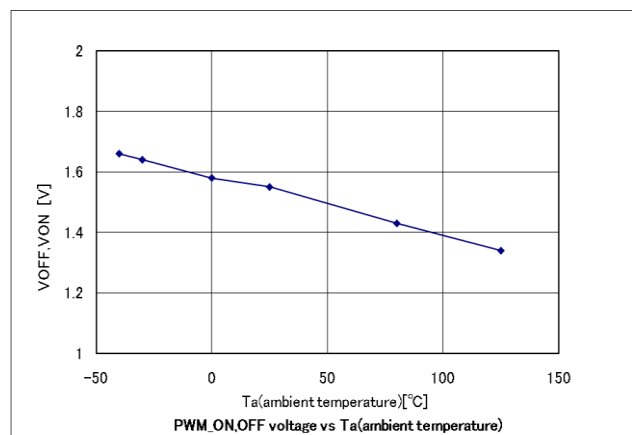
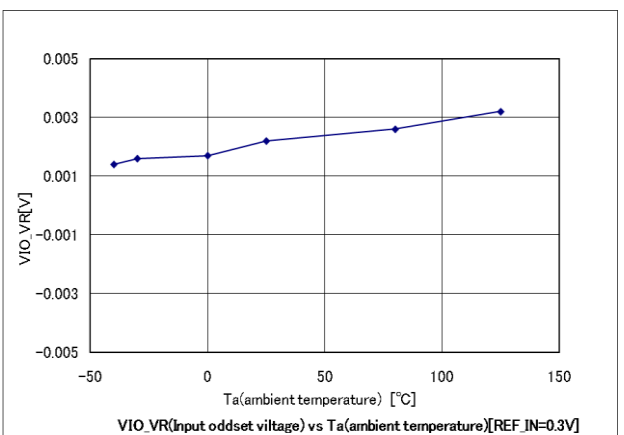
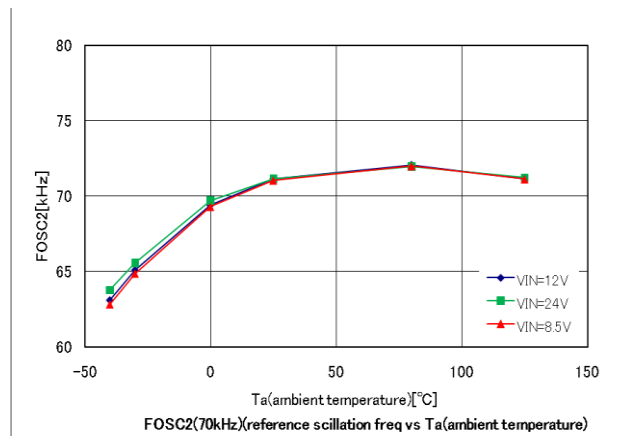
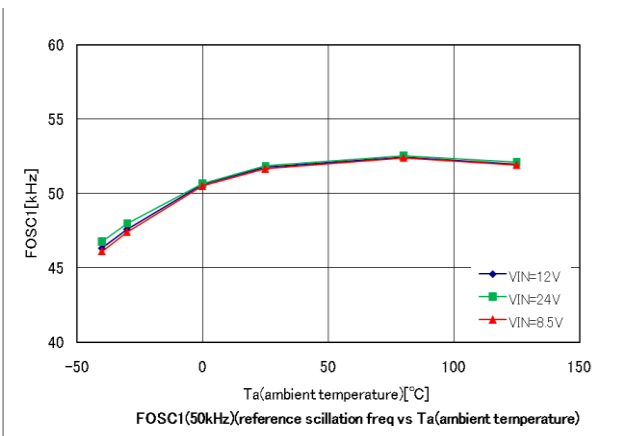
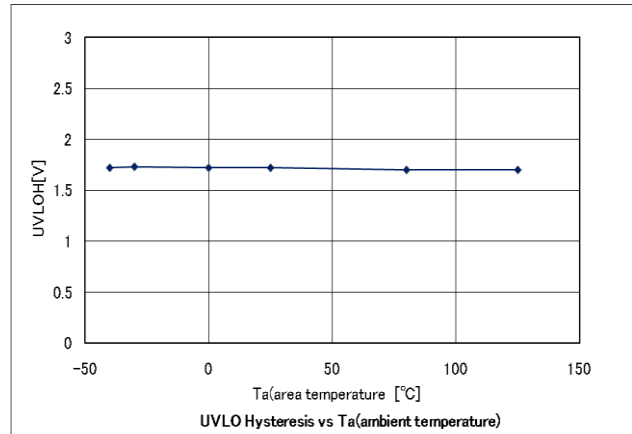
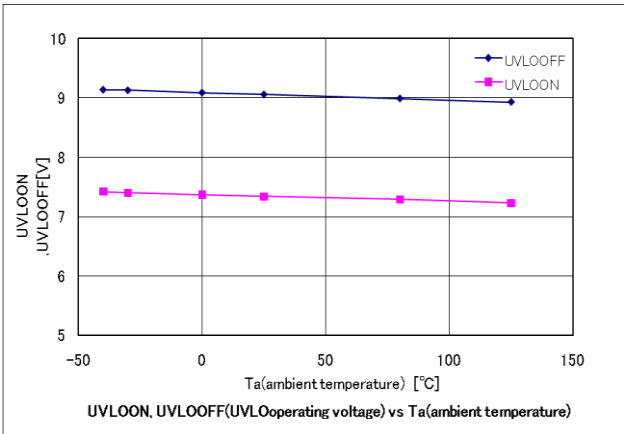
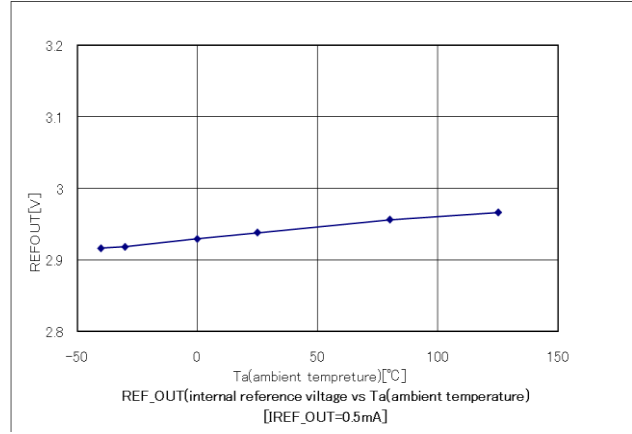
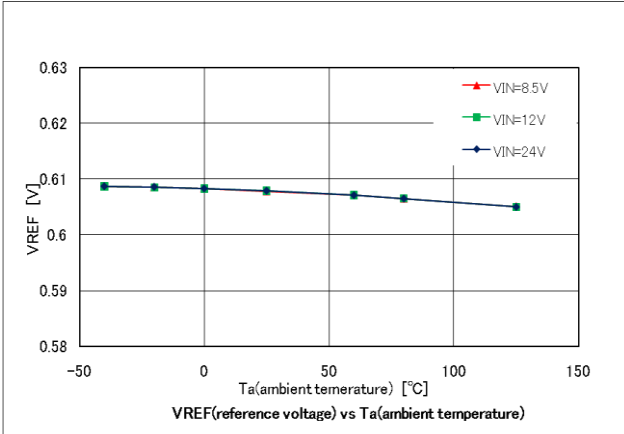

LV5026M

TYPICAL CHARACTERISTICS

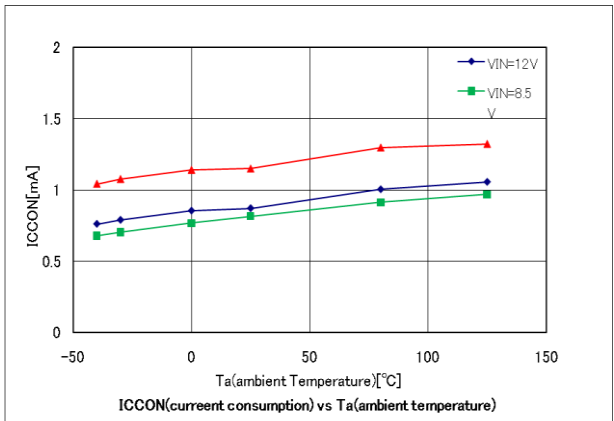
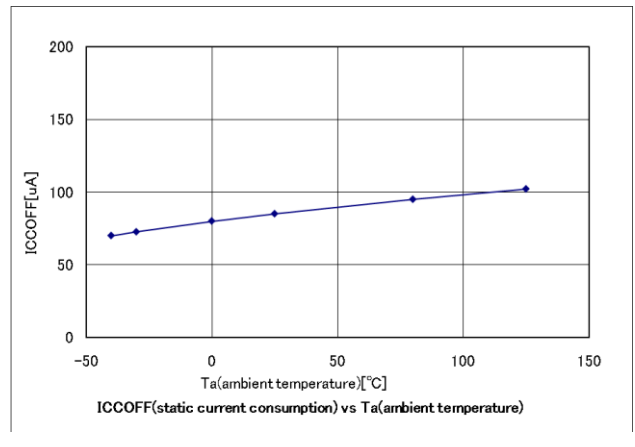
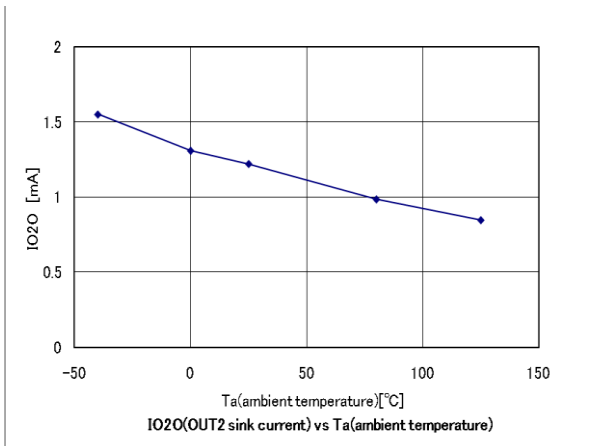
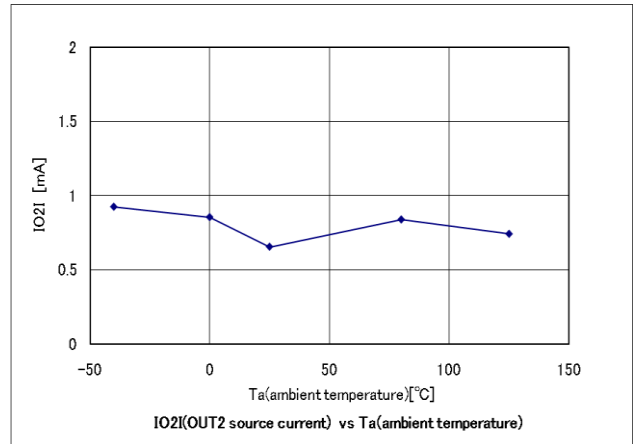
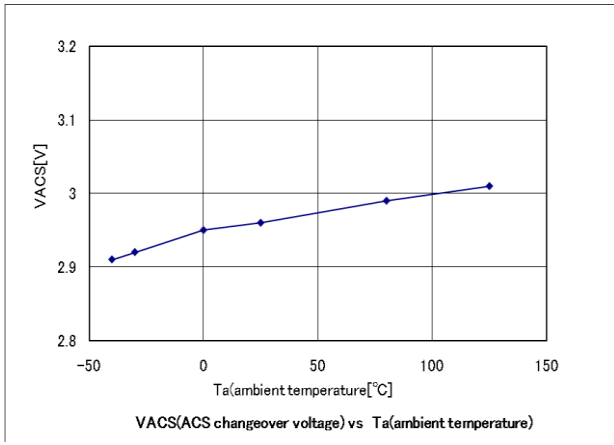
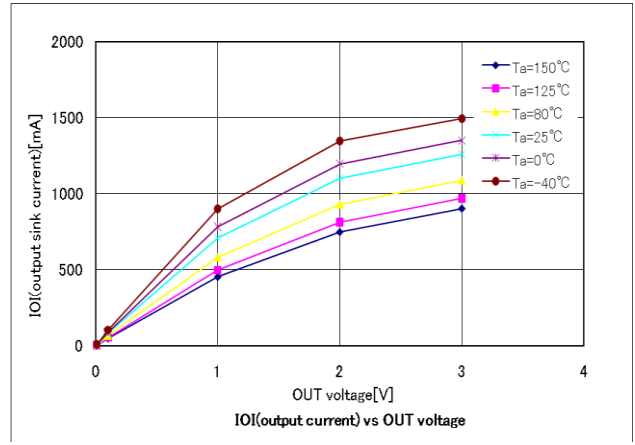
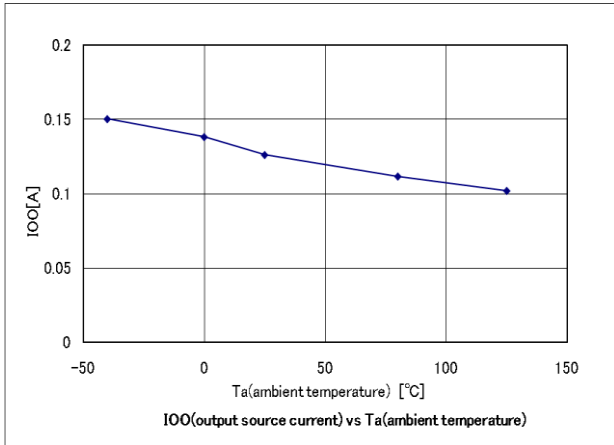

LV5026M

TYPICAL CHARACTERISTICS

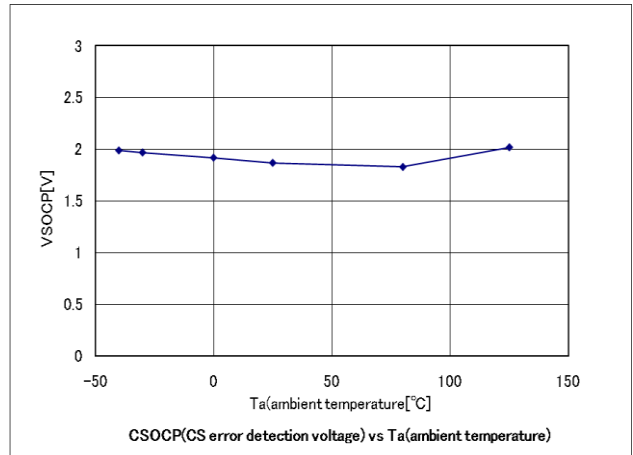
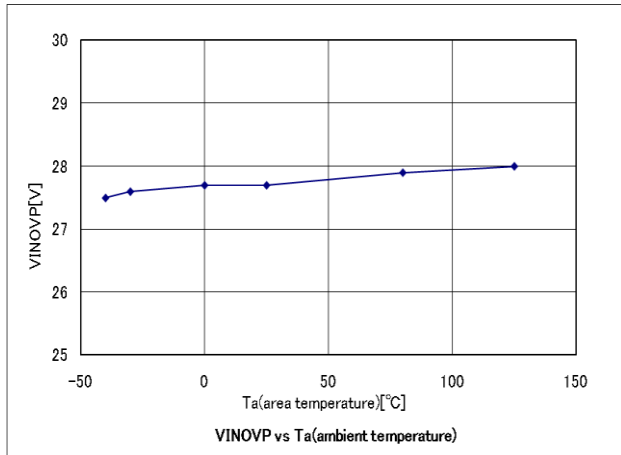

Block Diagram

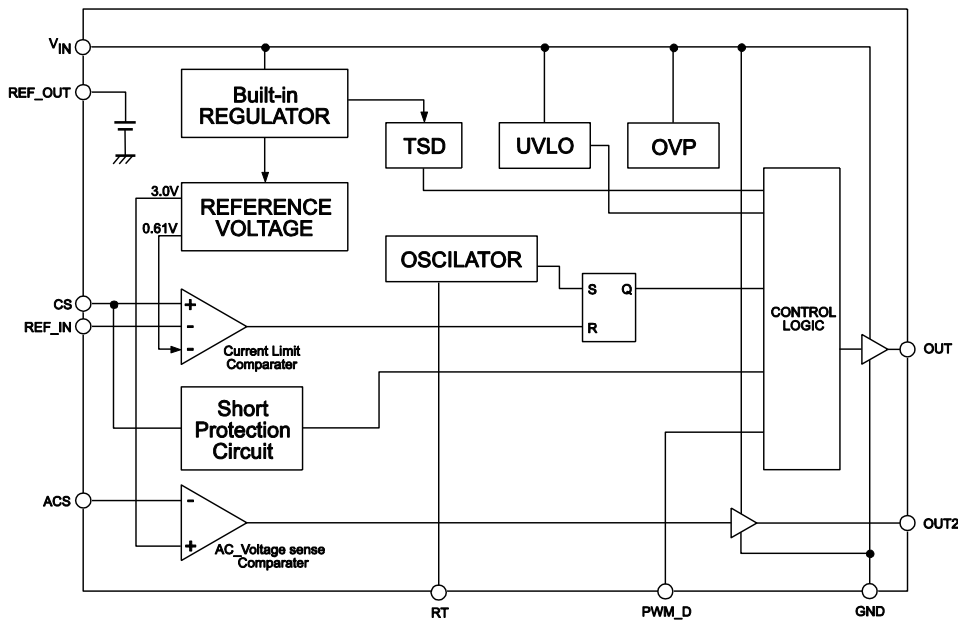

Sample Application Circuit

Non isolation

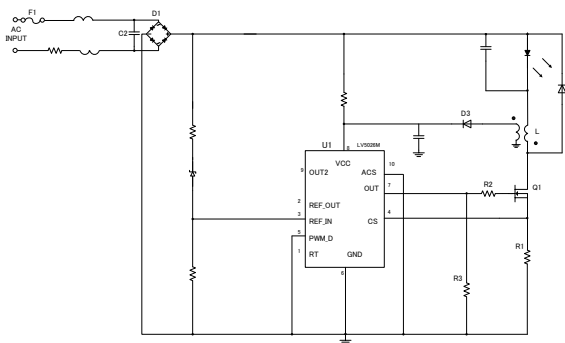

Isolation

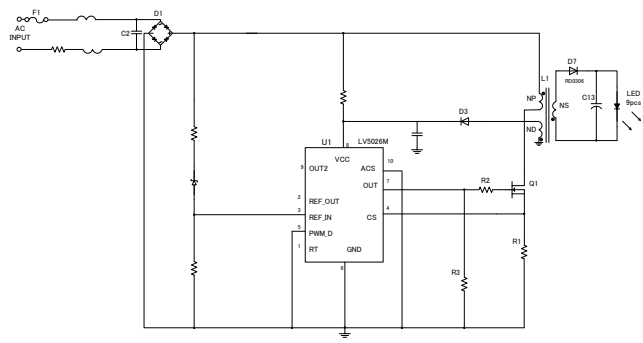

LV5026M

Package Dimensions

unit: mm (typ)

3086B

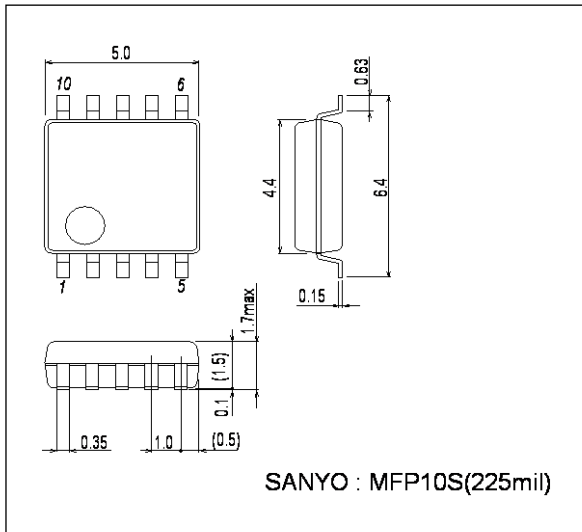

Pin Assignment

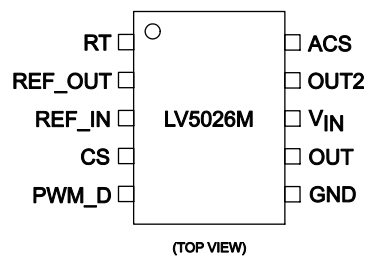

LV5026M

Pin Functions

pin No	Pin Name	Pin Function	Equivalent Circuit
1	RT	Switching Frequency selection pin. L or Open : 50kHz Switching, H: 70 kHz Switching. In case of 70kHz, connect RT pin to REFOUT pin. on time	
2	REF_OUT	Built-in 3V Regulate out Pin. If this function isn't used, please connect to nothing.	
3	REF_IN	External LED current Limit Setting pin. If less than VREF (0.61V) voltage is input, Peak current value is used at the input voltage. If more than REF_IN voltage is input, it is done at VREF voltage. If this function isn't used, please connect nothing.	
4	CS	LED current sensing in. If this terminal voltage exceeds VREF (Or REF_IN), external FET is OFF. And if the voltage of the terminal exceeds 1.9V, LV5026M turns to latch-off mode.	
5	PWM_D	PWM Dimming pin. L or open: normal operation, H: Stop operation.	
6	GND	GND pin.	
7	OUT	Driving the external FET Gate Pin.	
8	VIN	Power supply pin. Operation : VIN > UVLOON Stop: VIN < UVLOOFF Switching Stop : VIN > VINOVP	
9	OUT2	This pin drive the FET which is stabilized the TRIAC dimming application. If ACS is less than 3V, OUT2 turn High voltage. If this function isn't used, please connect nothing.	
10	ACS	ACS pin senses AC Voltage. If this function isn't used, please connect GND.	

• LED current and inductance setting

Relation ship between REF_IN and CS pin voltage(Power Factor Crrection(PFC))

The output current value is the average of the current value that flows during one cycle. The current value that flows into coil is a triangular wave shown in the figure below. Make sure to set Ipk so that (average of current value at one cycle) is equal to (LED current value).Ipk is set by the relationship between REF_IN voltage and Rcs voltage. This relationship make Power Factor Correction (PFC).Therefore, it is available to make LED current a sine curve.

Setting Zener voltage

Vzd depend on LED voltage (Vf). Choose Zener diode around Vf (LED voltage).When VAC voltage is lower than Vf, LED operation is not normal. Using Zener diode prevents incorrect operating during VAC voltage lower than Vf.In detail, refer to [LED current and inductance setting]

In case of REF_IN pin open, this error amplifier negative input(-) is under control of internal VREF voltage(0.605Vtyp).

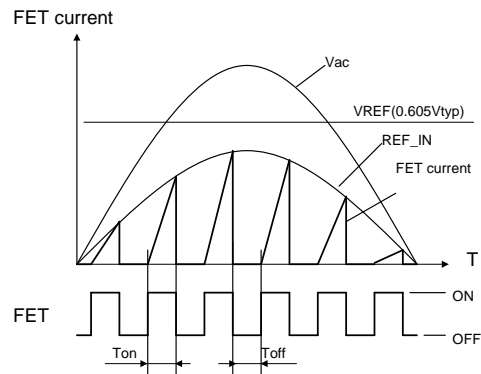
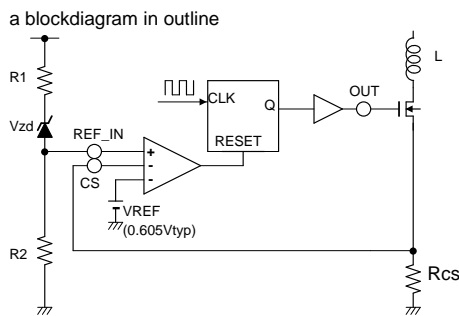

$$I_{pk} = \frac{(V_{ac} - V_{zd}) \times \frac{R2}{R1 + R2}}{R_{cs}}$$

- Ipk: peak inductor current
- Vf: LED forward voltage drop
- Vac: effective value,R.M.S value
- VREF: Built-in reference voltage (0.605V)
- VREF_IN:REF_IN voltage(6 pin)
- Rs: External sense resistor
- Vzd:Zener diode voltage(REF_IN pin)

LED current and inductance setting

It is available to use both no-isolation and isolation applications.

(For non-isolation application)

The output current value is the average of the current value that flows during one cycle. The current value that flows into coil is a triangular wave shown in the figure below. Make sure to set IL_PK so that (average of current value at one cycle) is equal to (LED current value).

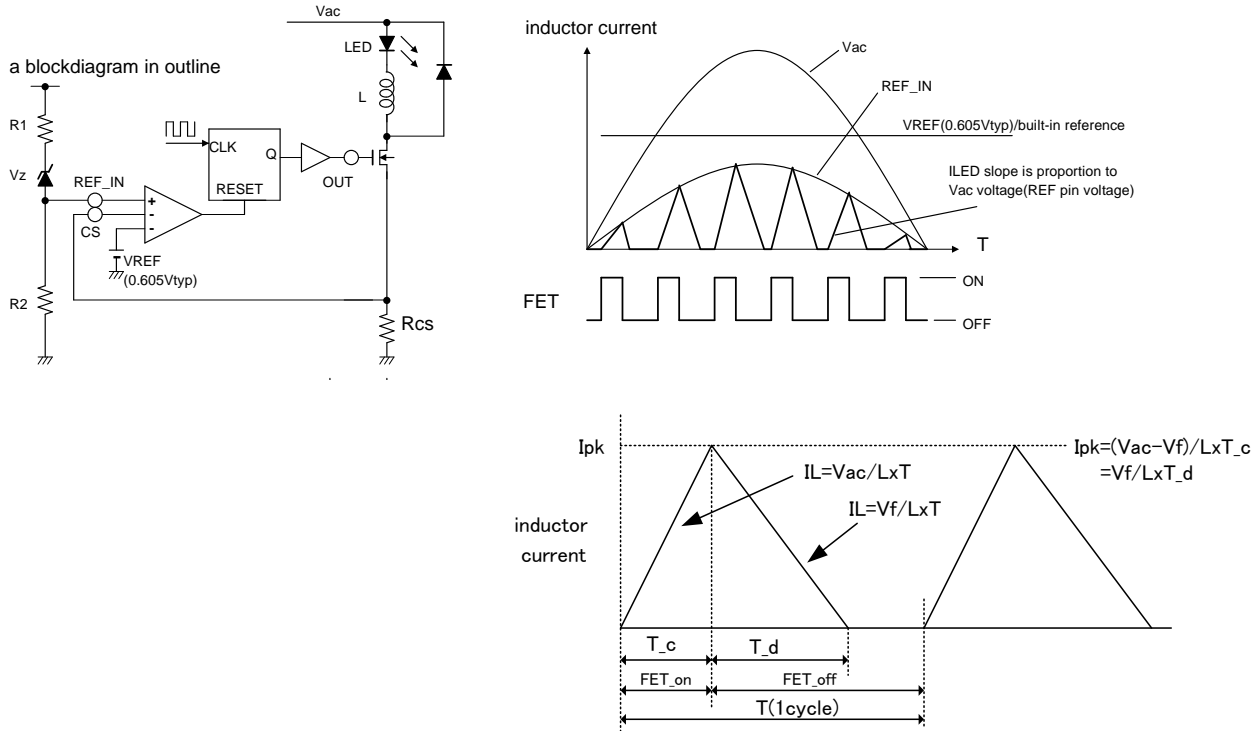

Given that the period when current flows into coil is

$$DutyI = \frac{T_{-c} + T_{-d}}{T}$$

$$I_{pk} \times \frac{1}{2} \times (DutyI \times T) / T = I_{LED}$$

$$I_{pk} = \frac{2 \times I_{LED}}{DutyI} \quad (1) \quad \text{since} \quad I_{pk} = \frac{V_{REF_IN}}{R_{cs}}$$

$$R_{cs} = \frac{V_{REF_IN}}{I_{pk}} = \frac{DutyI \times V_{REF_IN}}{2 \times I_{LED}} \quad (2)$$

- I_{pk}: peak inductor current
- V_f: LED forward voltage drop
- V_{ac}: effective value(R.M.S value)
- V_{REF}: Built-in reference voltage (0.605V)
- V_{REF_IN}: REF_IN voltage(6 pin)
- R_s: External sense resistor
- V_{zd}: Zener diode voltage(REF_IN pin)

Since formula for LED current is different between on period and off period as shown above,

$$I_{pk} = \frac{Vac - Vf}{L} \times T_{-c} = \frac{Vf}{L} \times T_{-d} \quad (3).$$

$$\text{Since } T_{-c} + T_{-d} = DutyI \times T, T_{-c} = DutyI \times T - T_{-d} \quad (4)$$

$$\text{Based on the result of (3) and (4), } T_{-d} = DutyI \times T \times \frac{Vac - Vf}{Vac} \quad (5)$$

To obtain L from the equation (1), (3), (5),

$$L = \frac{Vf \times DutyI}{2 \times I_{LED}} \times DutyI \times T \times \frac{Vac - Vf}{Vac} = \frac{Vf}{2 \times I_{LED}} \times \frac{1}{f_{osc}} \times \frac{Vac - Vf}{Vac} \times (DutyI)^2 \quad (6)$$

Since LED and inductor are connected in serial in non-isolation mode, LED current flows only when AC voltage exceed Vf.

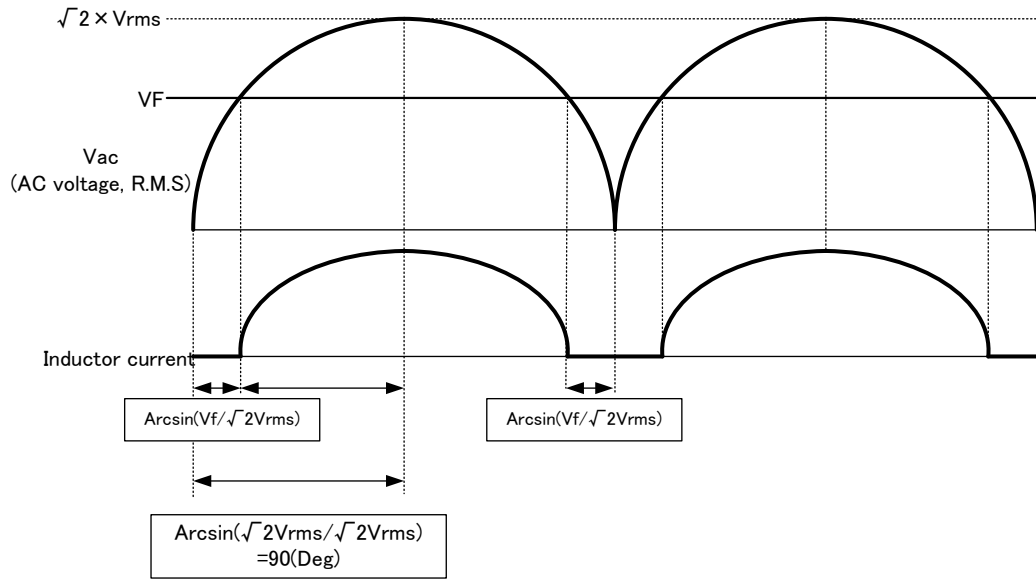

Given that the ratio of inductor current to AC input is DutyAC.

$$DutyAC = \frac{90 - \arcsin\left(\frac{V_f}{\sqrt{2} V_{rms}}\right)}{90}$$

Since the period when the inductor current flows are limited by DutyAC, the formula (6) is represented as follows:

$$L = \frac{V_f}{2 \times I_{LED}} \times \frac{1}{f_{osc}} \times \frac{V_{ac} - V_f}{V_{IN}} \times (DutyI)^2 \times \left(\frac{90 - \arcsin\left(\frac{V_f}{\sqrt{2} V_{rms}}\right)}{90} \right)^2 \quad (7)$$

(for Isolation circuit)

Using the circuit diagram below, the wave form of the current that flows to N_p and N_s is as follows.
Current waveform flows to primary side and secondary.

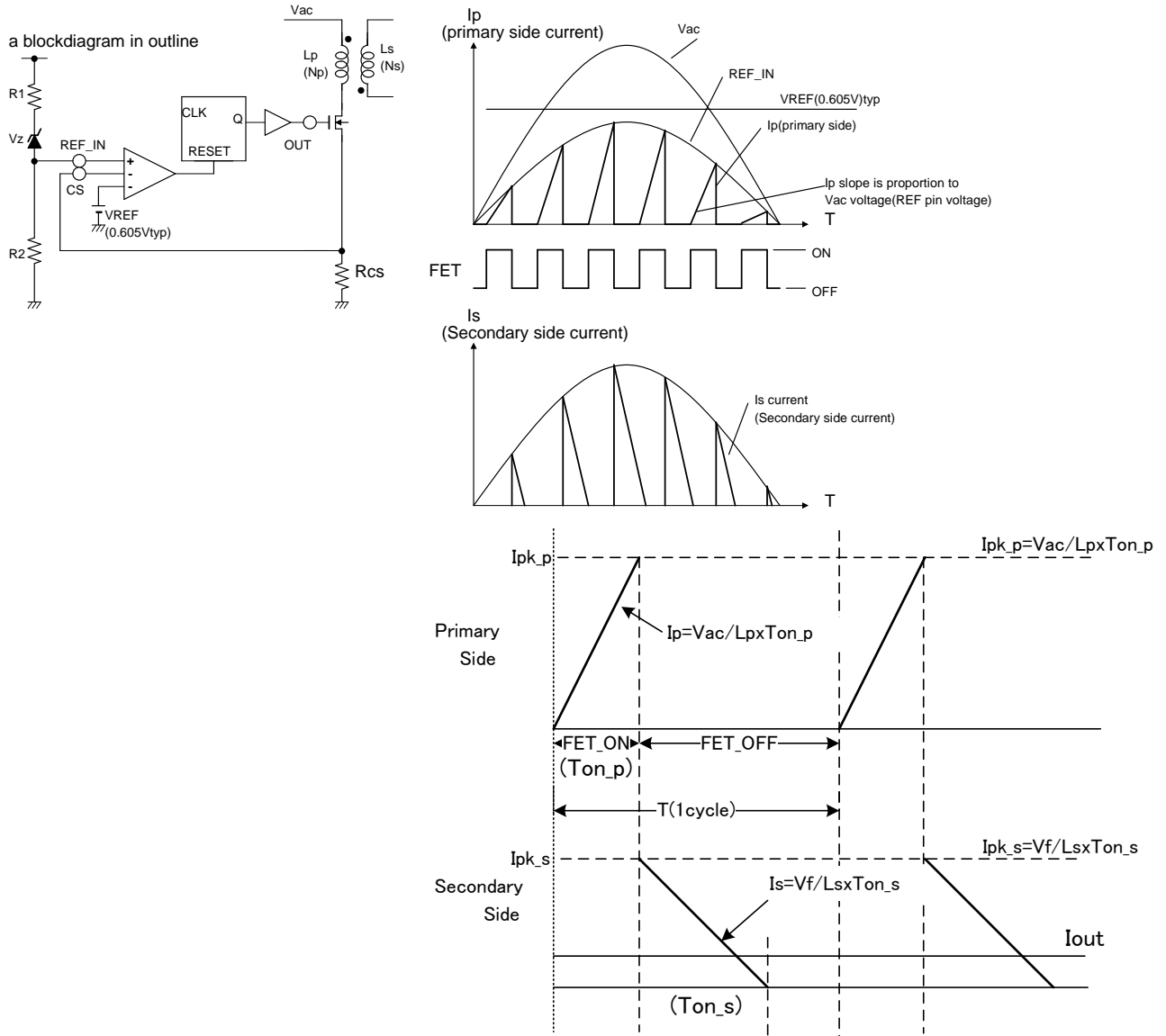

[Inductance L_p of primary side and sense resistor R_s]

If a peak current flow to transformer is represented as I_{pk_p} , the power (P_{in}) charged to the transformer on primary side can be represented as:

$$P_{in} = \frac{1}{2} \times L_p \times (I_{pk_p})^2 \times f_{osc} \quad (11).$$

$$\therefore I_{pk_p} = \frac{V_{ac}}{L_p} \times T_{on_p} \quad (12)$$

$$\therefore L_p = \frac{V_{ac}^2 \times T_{on_p}^2 \times f_{osc}}{2 \times P_{in}} = \frac{V_{ac}^2 \times D_{on_p}^2}{2 \times P_{in} \times f_{osc}} \quad (13)$$

$$(D_{on_p} = \frac{T_{on_p}}{T} = T_{on_p} \times f_{osc}),$$

To substitute the following to the formula below,

$$\therefore \eta = \frac{P_{out}}{P_{in}} \quad (14)$$

$$\therefore L_p = \frac{V_{ac}^2 \times T_{on_p}^2 \times f_{osc} \times \eta}{2 \times P_{out}} = \frac{V_{ac}^2 \times D_{on}^2 \times \eta}{2 \times P_{out} \times f_{osc}} \quad (15)$$

Sense resistor is obtained as follows.

$$R_s = \frac{VREF_IN}{Ipk_p} = \frac{VREF_IN \times Lp}{Vac \times Ton_p} = \frac{VREF_IN \times Lp}{Vac \times Don_p \times T} \quad (16)$$

[Inductance L_s of secondary side]

Since output current I_{out} is the average value of current flows to transformer of secondary side

$$I_{out} = Ipk_s \times \frac{Ton_s}{T} \times \frac{1}{2} = \frac{Ipk_s \times Don_s}{2} \quad (Don_s = \frac{Ton_s}{T} = Ton_s \times fosc) \quad (17)$$

$$Ipk_s = \frac{Vout}{Ls} \times Ton_s = \frac{Vout}{Ls} \times \frac{Don_s}{fosc} \quad (18)$$

$$Ls = \frac{Vout \times T \times Don_s^2}{2 \times I_{out}} = \frac{Vout \times Don_s^2}{2 \times I_{out} \times fosc} = \frac{Vout^2 \times Don_s^2}{2 \times Pout \times fosc} \quad (19)$$

Calculation of the ratio of transformer coil on primary side and secondary side

Since ratio and inductance of transformer coil is

$$\frac{Ns}{Np} = \frac{\sqrt{Ls}}{\sqrt{Lp}} \quad (20)$$

substituted equations (15), (19) for (20)

$$\therefore \frac{Np}{Ns} = \frac{Vac}{Vout} \times \sqrt{\eta} \times \frac{Don_p}{Don_s} \quad (21)$$

Calculation of transformer coil on primary side and secondary side

$$N = \frac{Vac \times 10^8}{2 \times \Delta B \times Ae \times fosc} \quad (22)$$

ΔB : variation range of core flux density [Gauss]

Ae : core section area [cm²]

To use Al (L value at 100T),

$$N = \sqrt{\frac{L}{Al}} \times 10^2 \quad (23)$$

L : inductance [uH]

Al : L value at 100T [uH/N²]

lg (Air gap) is obtained as follows:

$$lg = \frac{\mu_r \mu_0 N^2 Ae 10^2}{L} \quad (24)$$

μ_r : relative magnetic permeability, $\mu_r = 1$

μ_0 : vacuum magnetic permeability $\mu_0 = 4\pi \times 10^{-7}$

N : turn count [T]

Ae : core section area [m²]

L : inductance [H]

Bleeder current circuit for TRIAC dimmer

1. Operating voltage setting

ACS pin voltage set operating voltage at OUT2. ACS pin threshold voltage is 3Vtyp.
 OUT2 operating voltage is set by R1 and R2. R1 and R2 is determined below.

$$ACS = Vac \times \frac{R2}{R1 + R2}$$

2. Bleeder current setting

Rd set hold current at Triac dimmer.
 Bleeder current is set at Rd depending on Triac dimmer.

a blockdiagram in outline

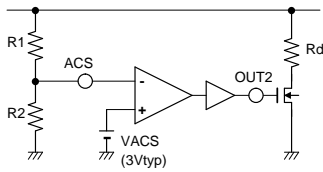

a blockdiagram in outline

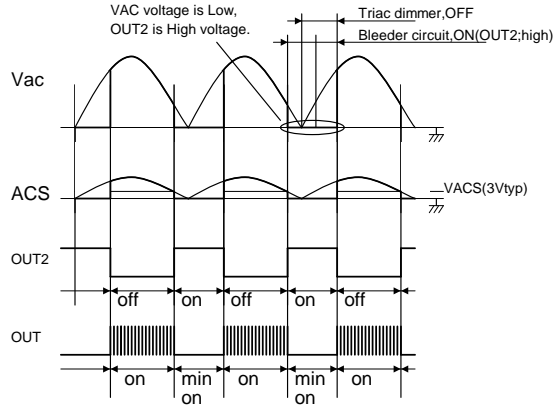

Description of operation protection function

	tilte	outline	monitor point	note
1	UVLO	Under Voltage Lock Out	VCC voltage	
2	OC	Over Current Protection	CS voltage	available FET current
3	OVP	Over Voltage Protection	VCC voltage	
4	OTP (TSD)	Over Temperature Protection (Thermal Shut Down)	PN Junction temperature	

1.UVLO(Under Voltage Lock Out)

If VIN voltage is 7.3V or lower, then UVLO operates and the IC stops. When UVLO operates, the power supply current of the IC is about 80uA or lower. If VIN voltage is 9V or higher, then the IC starts switching operation.

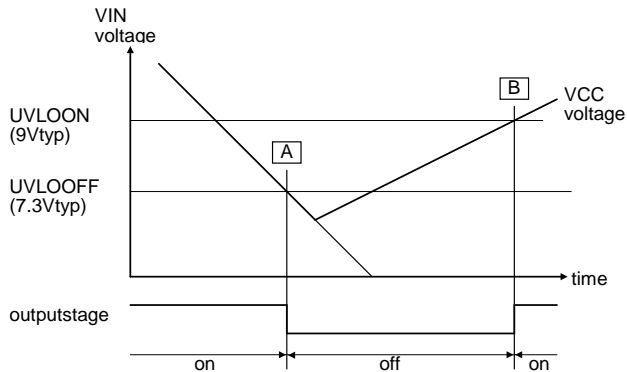

2.OCP(Over Current Protection)

The CS pin sense the current through the MOS FET switch and the primary side of the transformer.This provides an additional level of protection in the event of a fault. If the voltage of the CS pin exceeds VCSOCP(1.9Vtyp)(A), the internal comparator will detect the event and turn off the MOSFET. The peak switch current is calculated

$$I_o(\text{peak}) [A] = V\text{SOCP}[V]/R\text{sense}[\text{ohm}]$$

The VCC pin is pulled down to fixed level, keeping the controller latched off.The lach reset occurs when the user disconnects LED from VAC and lets the VCC falls below the VCC reset voltage,UVLOFF(7.3Vtyp)(B). Then VCC rise UVLOON(9Vtyp)(C),restart the switching.

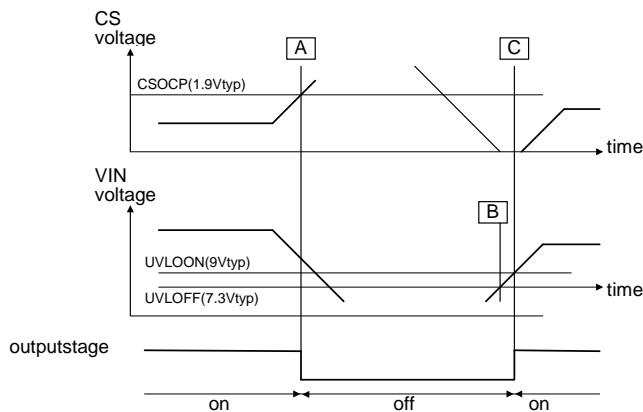

3.OVP(Over Voltage Protection)

If the voltage of VIN pin is higher than the internal reference voltage VINOVP(27Vtyp),switching operation is stopped. The stopping operation is kept until the voltage of VIN is lower than 7.3V. If the voltage of VIN pin is higher than 9V, the switching operation is restated.

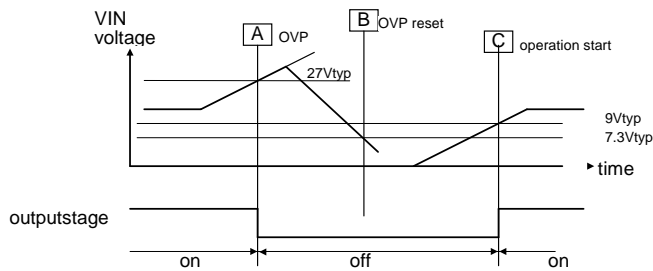

4. TSD(thermal Shut Down protection)

The thermal shutdown function works when the junction temperature of IC is 165deg (typ) (A), and the IC switching stops. The IC starts switching operation again when the junction temperature is 135°Ctyp (B) or lower.

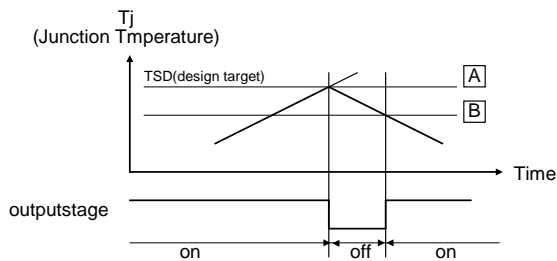

Skip frequency function

LV5026M contains the skip frequency function for reduction of the peak value of conduction noise. This function changes the frequency as follows.

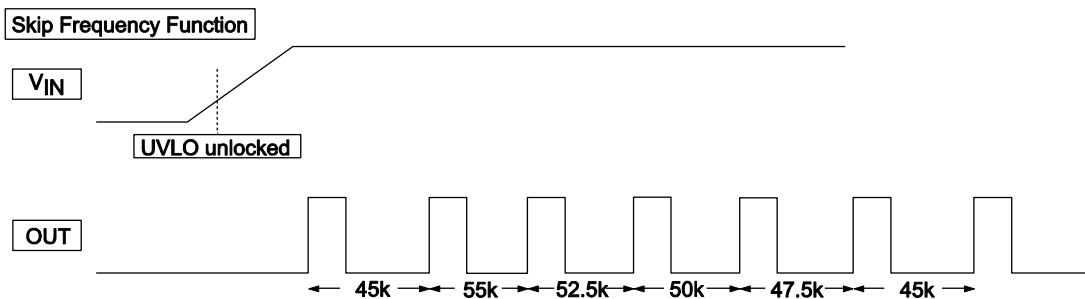

Switching frequency is changed as follows.
 ... ×0.9 → ×1.1 → ×1.05 → ×1 → ×0.95 → ×0.9 → ×1.1 ...
 It's repeated by this loop.

PWM dimmer function

LED current can be adjusted according to Duty of PWM pulse input to PWM dimmer pin. PWM pulse is High (2V to 5V) then switching operation stops, and LED current stops flowing. PWM pulse is Low (under 0.6V), then switching operation stop is released, and it returns to normal operation.

An outline of PWMD pin

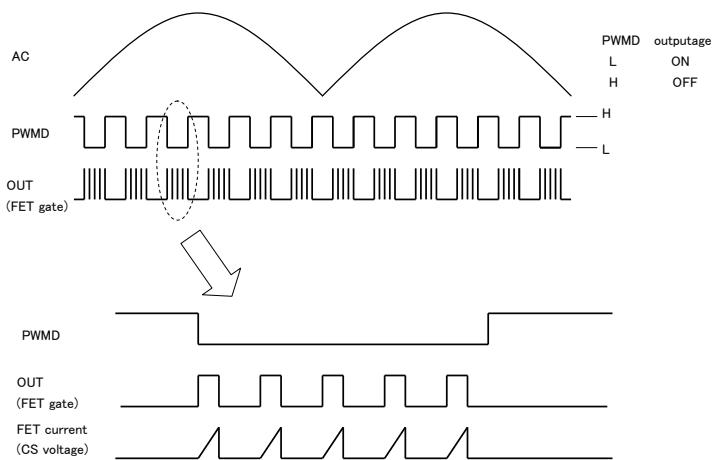
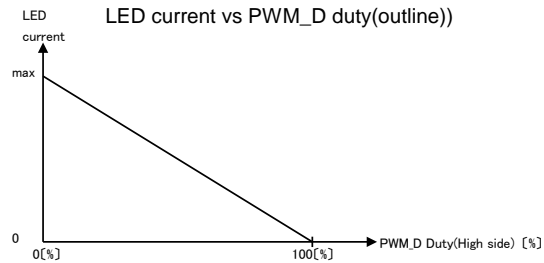
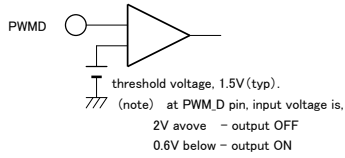

- SANYO Semiconductor Co.,Ltd. assumes no responsibility for equipment failures that result from using products at values that exceed, even momentarily, rated values (such as maximum ratings, operating condition ranges, or other parameters) listed in products specifications of any and all SANYO Semiconductor Co.,Ltd. products described or contained herein.
- SANYO Semiconductor Co.,Ltd. strives to supply high-quality high-reliability products, however, any and all semiconductor products fail or malfunction with some probability. It is possible that these probabilistic failures or malfunction could give rise to accidents or events that could endanger human lives, trouble that could give rise to smoke or fire, or accidents that could cause damage to other property. When designing equipment, adopt safety measures so that these kinds of accidents or events cannot occur. Such measures include but are not limited to protective circuits and error prevention circuits for safe design, redundant design, and structural design.
- In the event that any or all SANYO Semiconductor Co.,Ltd. products described or contained herein are controlled under any of applicable local export control laws and regulations, such products may require the export license from the authorities concerned in accordance with the above law.
- No part of this publication may be reproduced or transmitted in any form or by any means, electronic or mechanical, including photocopying and recording, or any information storage or retrieval system, or otherwise, without the prior written consent of SANYO Semiconductor Co.,Ltd.
- Any and all information described or contained herein are subject to change without notice due to product/technology improvement, etc. When designing equipment, refer to the "Delivery Specification" for the SANYO Semiconductor Co.,Ltd. product that you intend to use.
- Information (including circuit diagrams and circuit parameters) herein is for example only; it is not guaranteed for volume production.
- Upon using the technical information or products described herein, neither warranty nor license shall be granted with regard to intellectual property rights or any other rights of SANYO Semiconductor Co.,Ltd. or any third party. SANYO Semiconductor Co.,Ltd. shall not be liable for any claim or suits with regard to a third party's intellectual property rights which has resulted from the use of the technical information and products mentioned above.

This catalog provides information as of March, 2011. Specifications and information herein are subject to change without notice.