

BTA204S series B and C

Three-quadrant triacs high commutation

Rev. 03 — 24 May 2005

Product data sheet

1. Product profile

1.1 General description

Passivated high commutation triac in a SOT428 (DPAK) plastic package. Intended for use in circuits where high static and dynamic dV/dt and high dI/dt can occur. These devices will commute the full rated RMS current at the maximum rated junction temperature, without the aid of a snubber.

1.2 Features

- High maximum junction temperature
- High commutation capability

1.3 Applications

- Motor control
- Industrial and domestic heating

1.4 Quick reference data

- $V_{DRM} \leq 600$ V (BTA204S-600B)
- $V_{DRM} \leq 800$ V (BTA204S-800B)
- $V_{DRM} \leq 600$ V (BTA204S-600C)
- $V_{DRM} \leq 800$ V (BTA204S-800C)
- $I_{TSM} \leq 25$ A
- $I_{T(RMS)} \leq 4$ A

2. Pinning information

Table 1: Pinning

Pin	Description	Simplified outline	Symbol
1	main terminal 1 (T1)	<p>SOT428 (DPAK)</p>	
2	main terminal 2 (T2)		
3	gate (G)		
mb	mounting base [1]		

[1] Connected to main terminal 2 (T2)

3. Ordering information

Table 2: Ordering information

Type number	Package		Version
	Name	Description	
BTA204S-600B	DPAK	plastic single-ended surface mounted package; 3 leads (one lead cropped)	SOT428
BTA204S-600C			
BTA204S-800B			
BTA204S-800C			

4. Limiting values

Table 3: Limiting values

In accordance with the Absolute Maximum Rating System (IEC 60134).

Symbol	Parameter	Conditions	Min	Max	Unit
V_{DRM}	repetitive peak off-state voltage	BTA204S-600B; BTA204S-600C	[1] -	600	V
		BTA204S-800B; BTA204S-800C	-	800	V
$I_{\text{T(RMS)}}$	RMS on-state current	full sine wave; $T_{\text{mb}} \leq 107\text{ °C}$; see Figure 4 and 5	-	4	A
I_{TSM}	non-repetitive peak on-state current	full sine wave; $T_{\text{j}} = 25\text{ °C}$ prior to surge; see Figure 2 and 3			
		$t = 20\text{ ms}$	-	25	A
		$t = 16.7\text{ ms}$	-	27	A
I^2t	I^2t for fusing	$t = 10\text{ ms}$	-	3.1	A ² s
di_{T}/dt	repetitive rate of rise of on-state current after triggering	$I_{\text{TM}} = 6\text{ A}$; $I_{\text{G}} = 0.2\text{ A}$; $dI_{\text{G}}/dt = 0.2\text{ A}/\mu\text{s}$	-	100	A/ μs
I_{GM}	peak gate current		-	2	A
V_{GM}	peak gate voltage		-	5	V
P_{GM}	peak gate power		-	5	W
$P_{\text{G(AV)}}$	average gate power	over any 20 ms period	-	0.5	W
T_{stg}	storage temperature		-40	+150	°C
T_{j}	junction temperature		-	125	°C

[1] Although not recommended, off-state voltages up to 800 V may be applied without damage, but the triac may switch to the on-state. The rate of rise of current should not exceed 6 A/ μs .

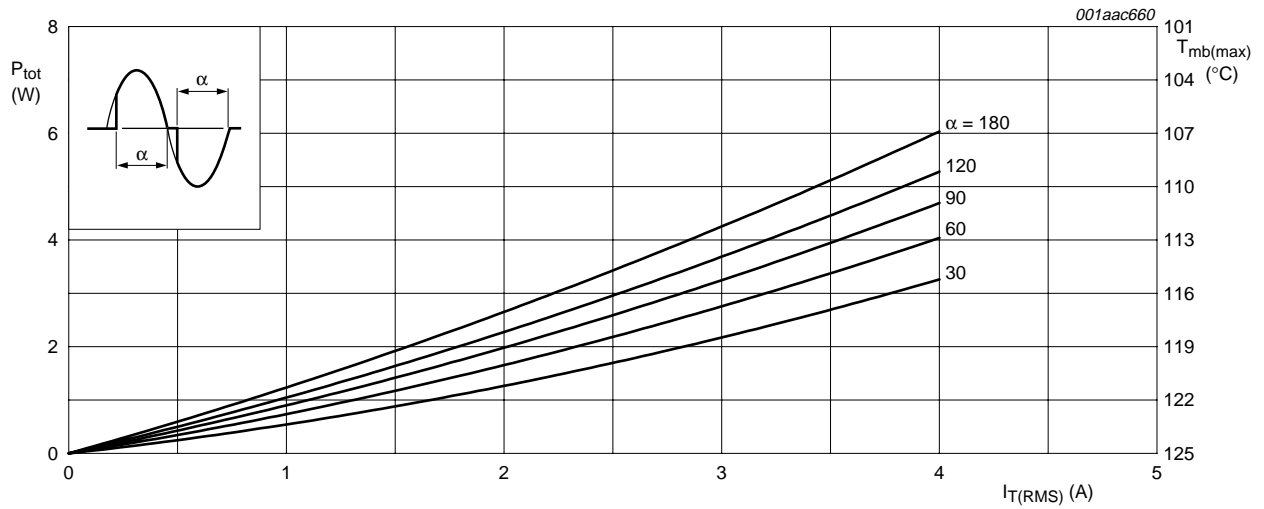

α = conduction angle

Fig 1. Total power dissipation as a function of RMS on-state current; maximum values

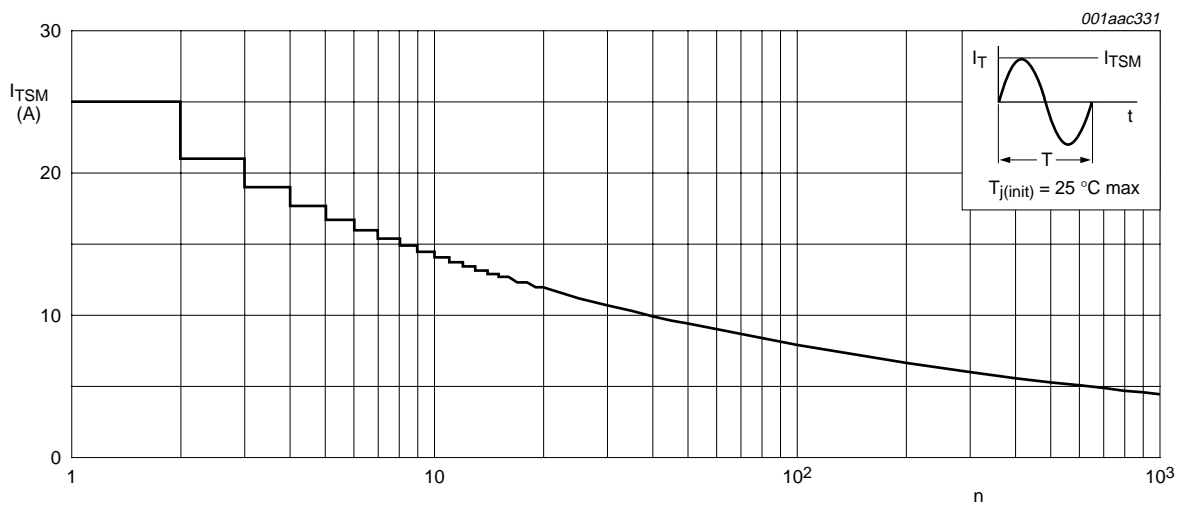

$f = 50$ Hz

Fig 2. Non-repetitive peak on-state current as a function of the number of sinusoidal cycles; maximum values

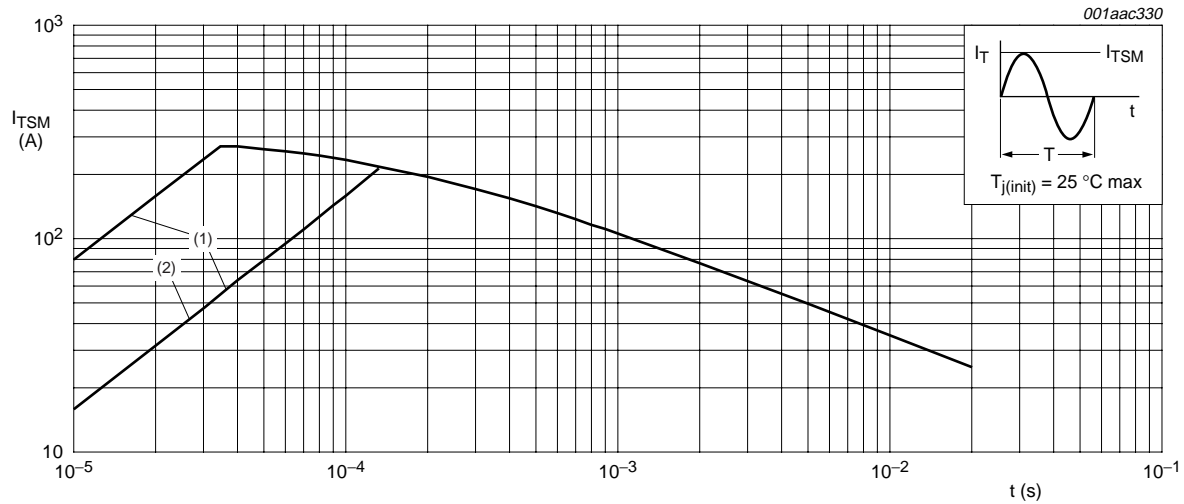

$t_p \leq 20\text{ ms}$

- (1) dI_T/dt limit
- (2) T2- G+ quadrant

Fig 3. Non-repetitive peak on-state current as a function of pulse width; maximum values

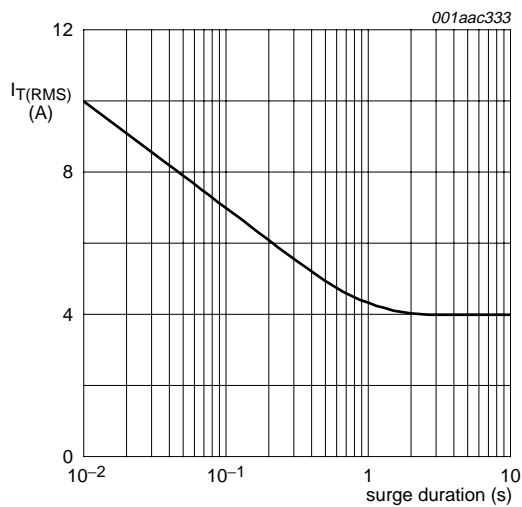

$f = 50\text{ Hz}; T_{mb} \leq 107\text{ °C}$

Fig 4. RMS on-state current as a function of surge duration; maximum values

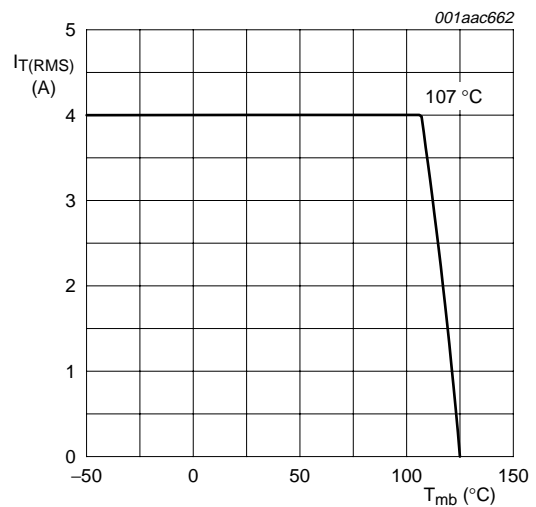
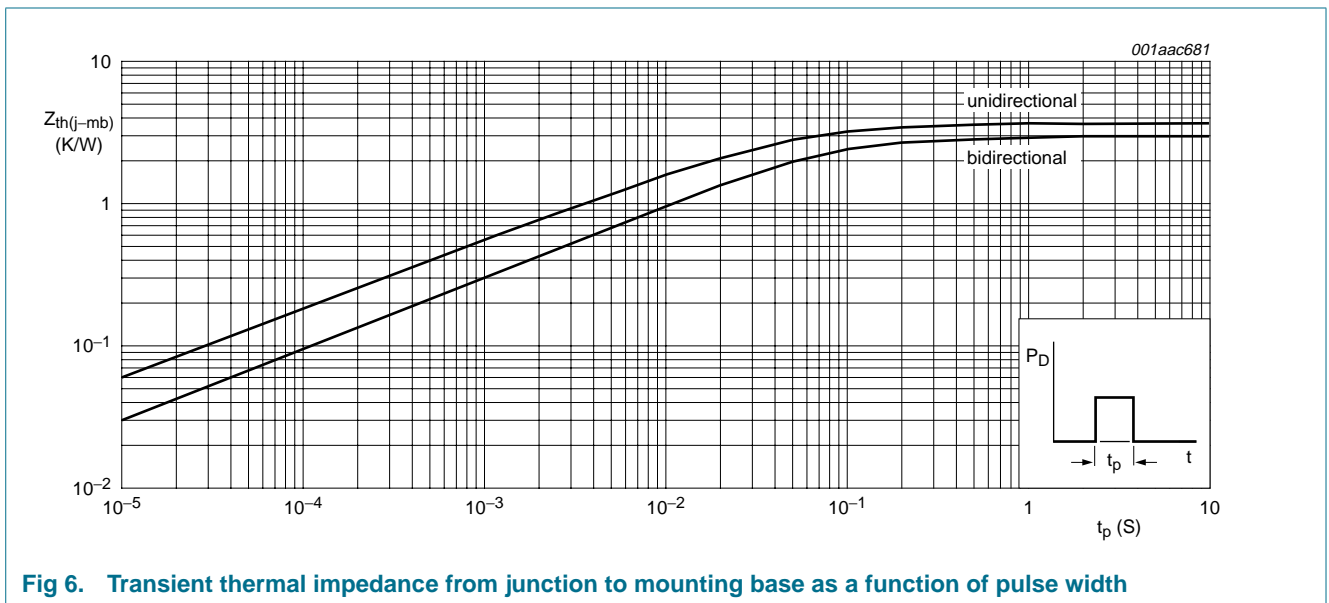

Fig 5. RMS on-state current as a function of mounting base temperature

5. Thermal characteristics

Table 4: Thermal characteristics

Symbol	Parameter	Conditions	Min	Typ	Max	Unit
$R_{th(j-mb)}$	thermal resistance from junction to mounting base	full cycle	-	-	3.0	K/W
		half cycle	-	-	3.7	K/W
$R_{th(j-a)}$	thermal resistance from junction to ambient	printed-circuit board (FR4) mounted as in Figure 13	-	75	-	K/W



6. Static characteristics

Table 5: Static characteristics
 $T_j = 25\text{ }^\circ\text{C}$ unless otherwise specified.

Symbol	Parameter	Conditions	BTA204S-600B BTA204S-800B			BTA204S-600C BTA204S-800C			Unit
			Min	Typ	Max	Min	Typ	Max	
I_{GT}	gate trigger current	$V_D = 12\text{ V}$; $I_T = 0.1\text{ A}$ see Figure 8 ^[1]							
		T2+ G+	-	-	50	-	-	35	mA
		T2+ G-	-	-	50	-	-	35	mA
I_L	latching current	$V_D = 12\text{ V}$; $I_{GT} = 0.1\text{ A}$; see Figure 10							
		T2+ G+	-	-	30	-	-	20	mA
		T2+ G-	-	-	45	-	-	30	mA
I_H	holding current	$V_D = 12\text{ V}$; $I_{GT} = 0.1\text{ A}$; see Figure 11	-	-	30	-	-	20	mA
		T2- G-	-	-	30	-	-	20	mA
		T2- G+	-	-	30	-	-	20	mA
V_T	on-state voltage	$I_T = 5\text{ A}$; see Figure 9	-	1.4	1.7	-	1.4	1.7	V
V_{GT}	gate trigger voltage	$V_D = 12\text{ V}$; $I_T = 0.1\text{ A}$; see Figure 7	-	0.7	1.5	-	0.7	1.5	V
		$V_D = 400\text{ V}$; $I_T = 0.1\text{ A}$; $T_j = 125\text{ }^\circ\text{C}$	0.25	0.4	-	0.25	0.4	-	V
I_D	off-state leakage current	$V_D = V_{DRM(max)}$; $T_j = 125\text{ }^\circ\text{C}$	-	0.1	0.5	-	0.1	0.5	mA

[1] Device does not trigger in the T2- G+ quadrant.

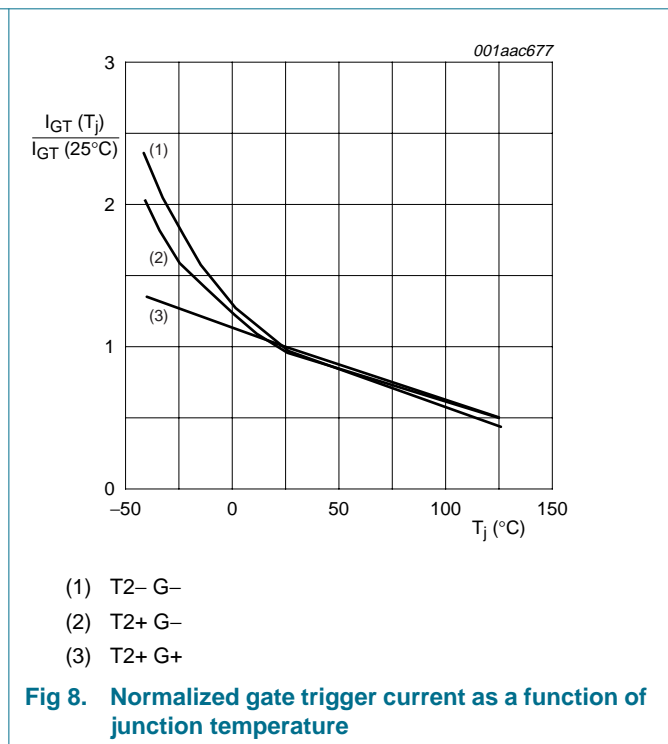
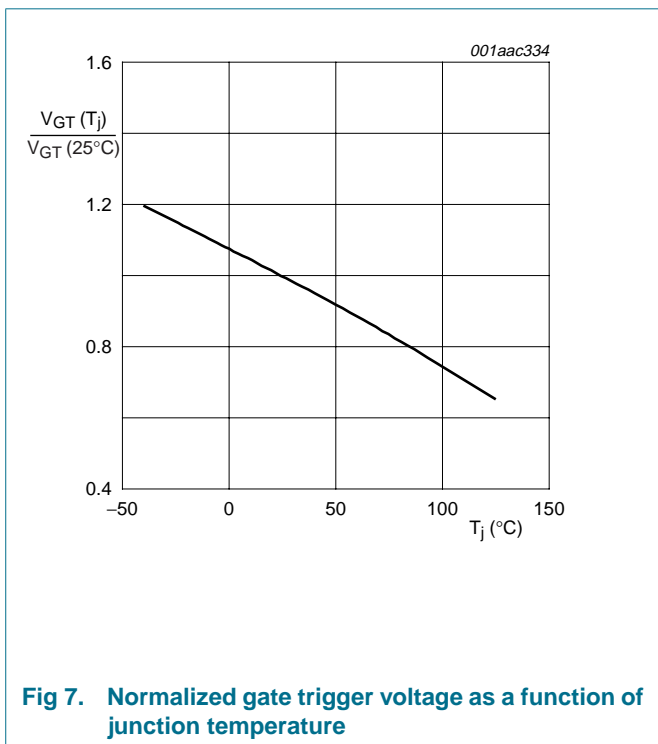

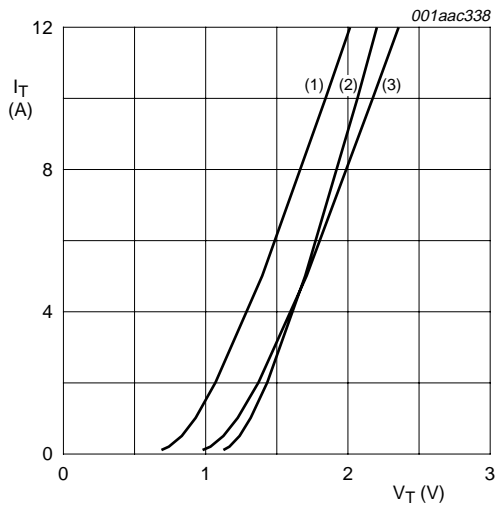

$V_O = 1.27 \text{ V}; R_S = 0.091 \Omega$

- (1) $T_j = 125 \text{ }^\circ\text{C}$; typical values
- (2) $T_j = 25 \text{ }^\circ\text{C}$; maximum values
- (3) $T_j = 125 \text{ }^\circ\text{C}$; maximum values

Fig 9. On-state current as a function of on-state voltage; typical values

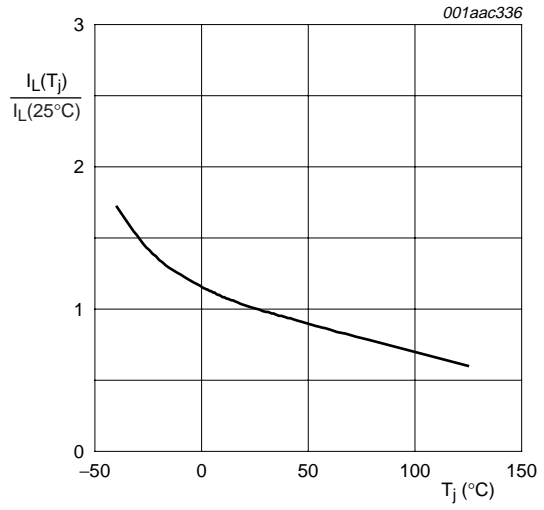

Fig 10. Normalized latching current as a function of junction temperature

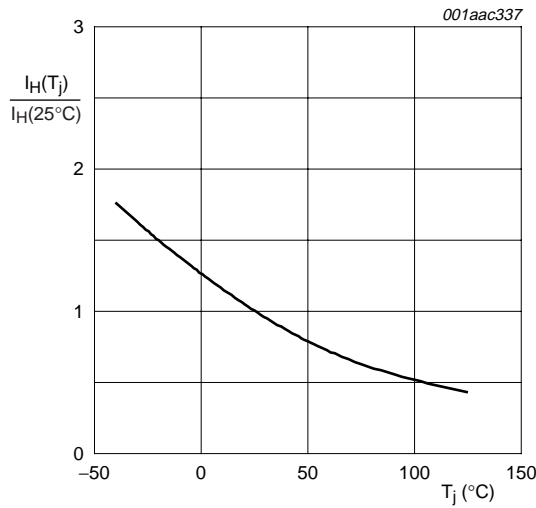

Fig 11. Normalized holding current as a function of junction temperature

7. Dynamic characteristics

Table 6: Dynamic characteristics

$T_j = 25\text{ °C}$ unless otherwise specified.

Symbol	Parameter	Conditions	BTA204S-600B BTA204S-800B			BTA204S-600C BTA204S-800C			Unit
			Min	Typ	Max	Min	Typ	Max	
dV_D/dt	critical rate of rise of off-state voltage	$V_{DM} = 0.67V_{DRM(max)}$; $T_j = 125\text{ °C}$; exponential waveform; gate open circuit	1000	-	-	1000	-	-	V/ μ s
dI_{com}/dt	critical rate of change of commutating current	$V_{DM} = 400\text{ V}$; $T_j = 125\text{ °C}$; $I_{T(RMS)} = 4\text{ A}$; $dV_{com}/dt = 20\text{ V}/\mu\text{s}$; gate open circuit	6	-	-	3	-	-	A/ms
t_{gt}	gate controlled turn-on time	$I_{TM} = 12\text{ A}$; $V_D = V_{DRM(max)}$; $I_G = 0.1\text{ A}$; $dI_G/dt = 5\text{ A}/\mu\text{s}$	-	2	-	-	2	-	μ s

8. Package information

Refer to mounting instructions for SOT428 (DPAK) package.

Plastic meets requirements of UL94 V-0 at $1/8$ inch.

9. Package outline

Plastic single-ended surface mounted package (DPAK); 3 leads (one lead cropped)

SOT428

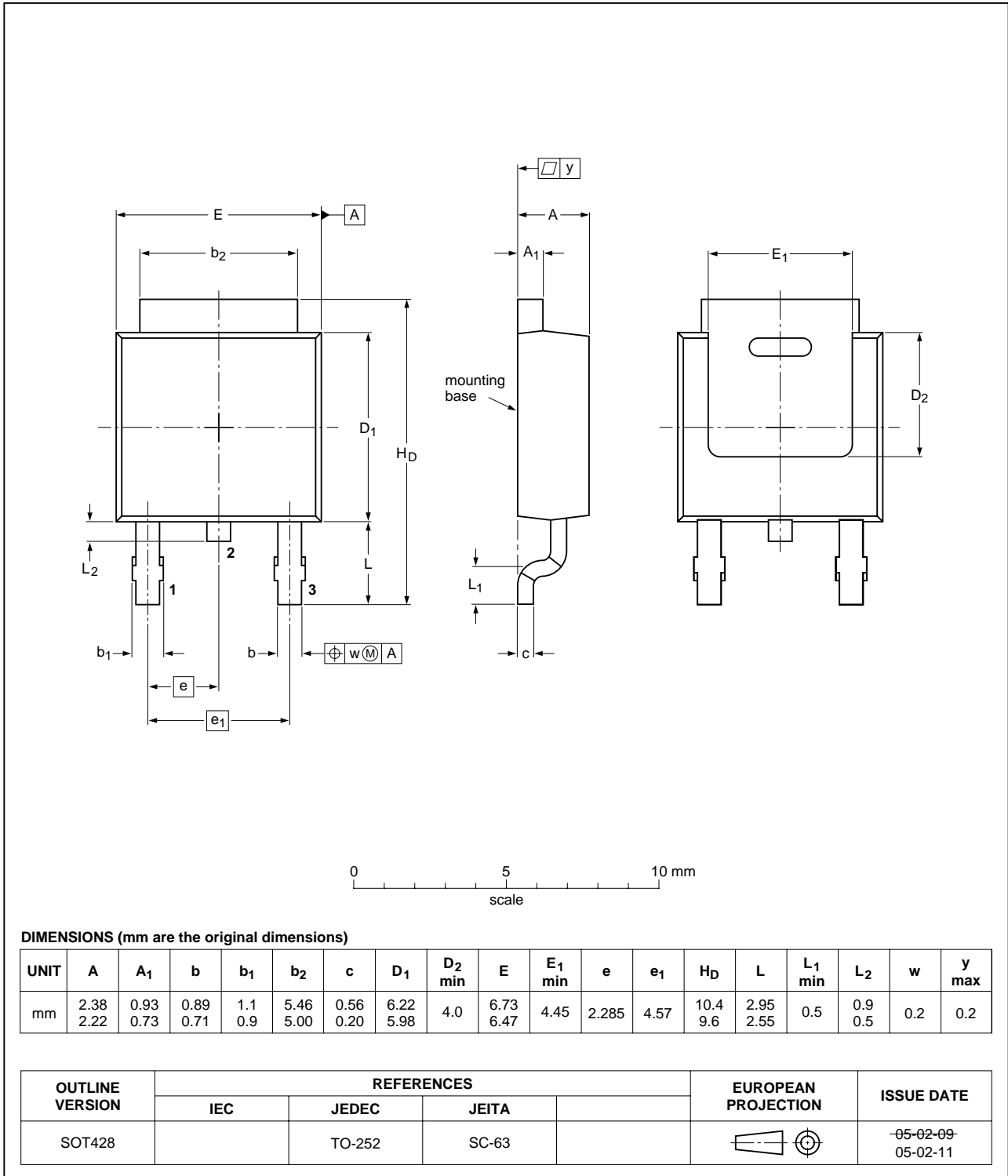
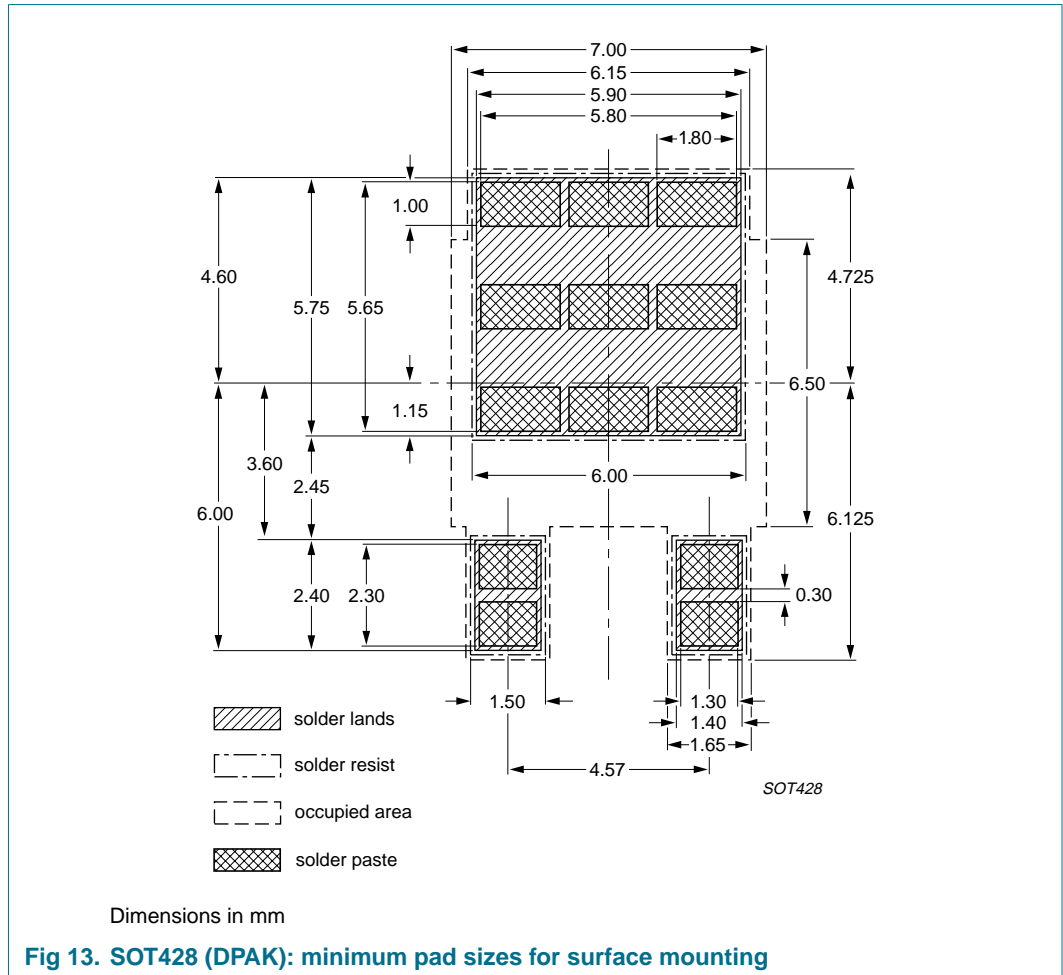

Fig 12. Package outline SOT428 (DPAK)

10. Mounting



11. Revision history

Table 7: Revision history

Document ID	Release date	Data sheet status	Change notice	Doc. number	Supersedes
BTA204S_SER_B_C_3	20050524	Product data sheet	-	9397 750 14862	BTA204S_SERIES_B_C_2
Modifications:			<ul style="list-style-type: none">• The format of this data sheet has been redesigned to comply with the new presentation and information standard of Philips Semiconductors• 500 V types removed• Alternative pinning types removed		
BTA204S_SERIES_B_C_2	19981201	Product specification	-	n.a.	BTA204S_SERIES_B_C_1
BTA204S_SERIES_B_C_1	19971001	Objective specification	-	n.a.	-

12. Data sheet status

Level	Data sheet status ^[1]	Product status ^{[2] [3]}	Definition
I	Objective data	Development	This data sheet contains data from the objective specification for product development. Philips Semiconductors reserves the right to change the specification in any manner without notice.
II	Preliminary data	Qualification	This data sheet contains data from the preliminary specification. Supplementary data will be published at a later date. Philips Semiconductors reserves the right to change the specification without notice, in order to improve the design and supply the best possible product.
III	Product data	Production	This data sheet contains data from the product specification. Philips Semiconductors reserves the right to make changes at any time in order to improve the design, manufacturing and supply. Relevant changes will be communicated via a Customer Product/Process Change Notification (CPCN).

[1] Please consult the most recently issued data sheet before initiating or completing a design.

[2] The product status of the device(s) described in this data sheet may have changed since this data sheet was published. The latest information is available on the Internet at URL <http://www.semiconductors.philips.com>.

[3] For data sheets describing multiple type numbers, the highest-level product status determines the data sheet status.

13. Definitions

Short-form specification — The data in a short-form specification is extracted from a full data sheet with the same type number and title. For detailed information see the relevant data sheet or data handbook.

Limiting values definition — Limiting values given are in accordance with the Absolute Maximum Rating System (IEC 60134). Stress above one or more of the limiting values may cause permanent damage to the device. These are stress ratings only and operation of the device at these or at any other conditions above those given in the Characteristics sections of the specification is not implied. Exposure to limiting values for extended periods may affect device reliability.

Application information — Applications that are described herein for any of these products are for illustrative purposes only. Philips Semiconductors make no representation or warranty that such applications will be suitable for the specified use without further testing or modification.

14. Disclaimers

Life support — These products are not designed for use in life support appliances, devices, or systems where malfunction of these products can reasonably be expected to result in personal injury. Philips Semiconductors

16. Contact information

For additional information, please visit: <http://www.semiconductors.philips.com>

For sales office addresses, send an email to: sales.addresses@www.semiconductors.philips.com

customers using or selling these products for use in such applications do so at their own risk and agree to fully indemnify Philips Semiconductors for any damages resulting from such application.

Right to make changes — Philips Semiconductors reserves the right to make changes in the products - including circuits, standard cells, and/or software - described or contained herein in order to improve design and/or performance. When the product is in full production (status 'Production'), relevant changes will be communicated via a Customer Product/Process Change Notification (CPCN). Philips Semiconductors assumes no responsibility or liability for the use of any of these products, conveys no license or title under any patent, copyright, or mask work right to these products, and makes no representations or warranties that these products are free from patent, copyright, or mask work right infringement, unless otherwise specified.

15. Trademarks

Notice — All referenced brands, product names, service names and trademarks are the property of their respective owners.

17. Contents

1	Product profile	1
1.1	General description	1
1.2	Features	1
1.3	Applications	1
1.4	Quick reference data	1
2	Pinning information	1
3	Ordering information	2
4	Limiting values	2
5	Thermal characteristics	5
6	Static characteristics	6
7	Dynamic characteristics	8
8	Package information	8
9	Package outline	9
10	Mounting	10
11	Revision history	11
12	Data sheet status	12
13	Definitions	12
14	Disclaimers	12
15	Trademarks	12
16	Contact information	12



© Koninklijke Philips Electronics N.V. 2005

All rights are reserved. Reproduction in whole or in part is prohibited without the prior written consent of the copyright owner. The information presented in this document does not form part of any quotation or contract, is believed to be accurate and reliable and may be changed without notice. No liability will be accepted by the publisher for any consequence of its use. Publication thereof does not convey nor imply any license under patent- or other industrial or intellectual property rights.

Date of release: 24 May 2005
Document number: 9397 750 14862

Published in The Netherlands