

DF2005-G Thru. DF210-G

Reverse Voltage: 50 to 1000V

Forward Current: 2.0A

RoHS Device

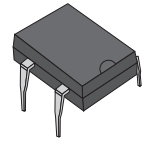

Features

- Rating to 1000V PRV
- Ideal for printed circuit board
- Low forward voltage drop,high current capability
- Reliable low cost construction utilizing molded plastic technique results in inexpensive product
- The plastic material has UL flammability classification 94V-0

Mechanical Data

- Polarit: As marked on Body
- Weight: 0.38 grams
- Mounting position: Any

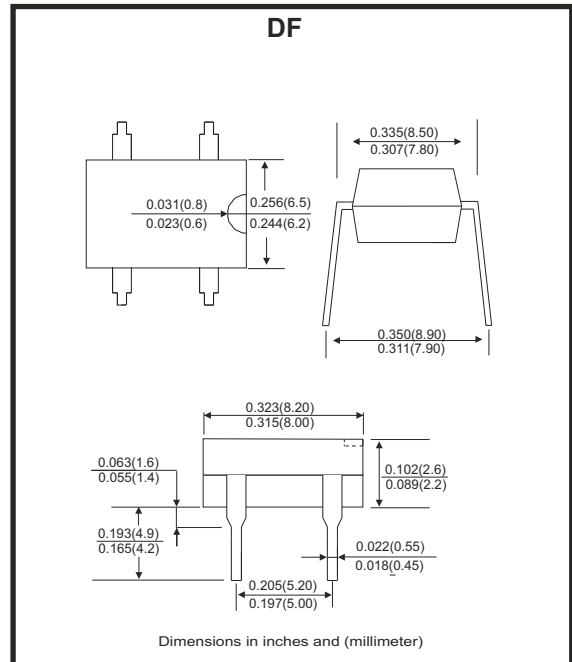

Maximum ratings and electrical characteristics

Rating at 25°C ambient temperature unless otherwise specified.
 Single phase, half wave ,60Hz, resistive or inductive load.
 For capacitive load, derate current by 20%

Parameter	Symbol	DF2005-G	DF201-G	DF202-G	DF204-G	DF206-G	DF208-G	DF210-G	Unit
Maximum Reverse Peak Repetitive Voltage	V_{RRM}	50	100	200	400	600	800	1000	V
Maximum RMS Voltage	V_{RMS}	35	70	140	280	420	560	700	V
Maximum DC Blocking Voltage	V_{DC}	50	100	200	400	600	800	1000	V
Maximum Average Forward Rectified Current @ $T_A=40^{\circ}C$	$I_{(AV)}$	2.0							A
Peak Forward Surge Current , 8.3ms Single Half Sine-Wave Super Imposed on Rated Load	I_{FSM}	60							A
$I^2 t$ Rating for Fusing ($t < 8.3ms$)	$I^2 t$	10.4							$A^2 s$
Maximum Forward Voltage at 2.0A DC	V_F	1.1							V
Maximum DC Reverse Current @ $T_J = 25^{\circ}C$ at Rated DC Blocking Voltage @ $T_J = 125^{\circ}C$	I_R	10 500							μA
Typical Junction Capacitance Per Element (Note 1)	C_J	25							pF
Typical Thermal Resistance (Note 2)	$R_{\theta JA}$	40							$^{\circ}C/W$
Operating Temperature Range	T_J	-55 ~ +150							$^{\circ}C$
Storage Temperature Range	T_{STG}	-55 ~ +150							$^{\circ}C$

Notes:
 1. Measured at 1.0MHz and applied reverse voltage of 4.0V DC
 2. Unit mounted on P.C.B with 0.50"×0.50" (13×13mm) copper pads.

Rating and Characteristics Curves (DF2005-G Thru. DF210-G)

FIG.1 - Derating Curve For Output Rectified Current

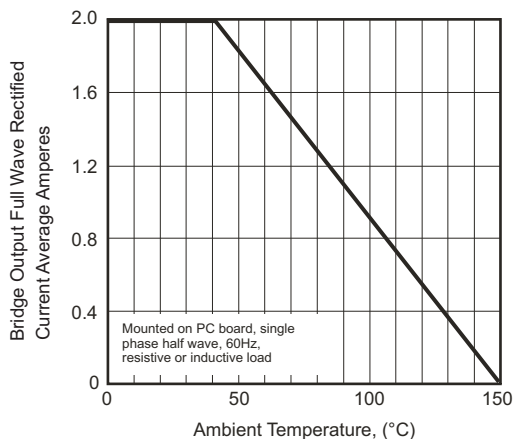

FIG. 2 - Maximum Non-Repetitive Peak Forward Surge Current

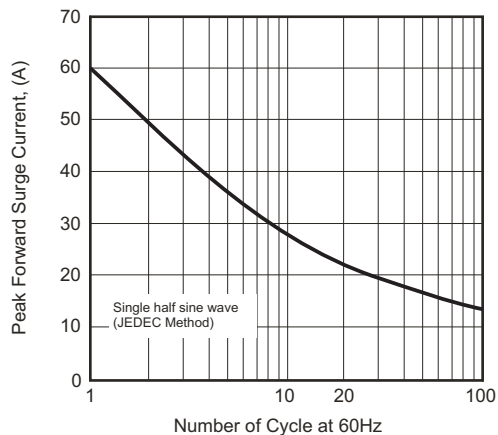

Fig.3 - Typical Junction Capacitance

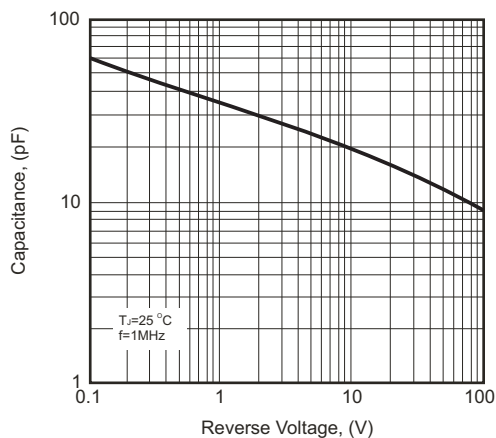

Fig.4 - Typical Forward Characteristics

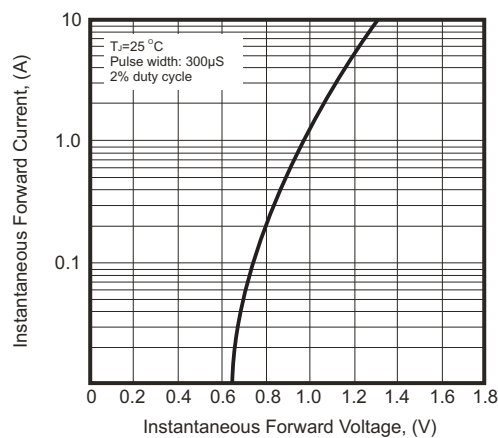
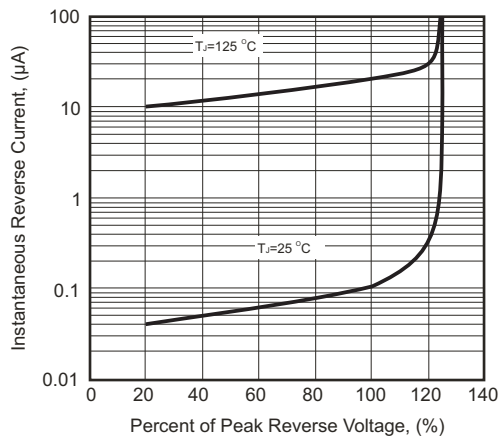
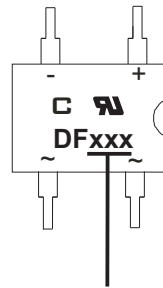

Fig.5 - Typical Reverse Characteristics



Marking Code

Part Number	Marking code
DF2005-G	DF2005
DF201-G	DF201
DF202-G	DF202
DF204-G	DF204
DF206-G	DF206
DF208-G	DF208
DF210-G	DF210



XX / XXX = Product type marking code
 C = Comchip Logo

Standard Packaging

Case Type	TUBE PACK	
	TUBE (pcs)	BOX (pcs)
DF	50	2,500